

UC Office of the President

UC Publications in Entomology

Title

Phylogenetic Relationships within Heliodinidae and Systematics of Moths Formerly Assigned to Heliodines Stainton (Lepidoptera: Yponomeutoidea)

Permalink

<https://escholarship.org/uc/item/8679h5mj>

Authors

Hsu, Yu-Feng
Powell, Jerry A.

Publication Date

2004-11-01

Peer reviewed

UNIVERSITY OF CALIFORNIA PUBLICATIONS

ENTOMOLOGY

VOLUME 124

**Phylogenetic Relationships
within Heliodinidae and
Systematics of Moths Formerly
Assigned to *Heliodines* Stainton
(Lepidoptera: Yponomeutoidea)**

Yu-Feng Hsu and Jerry A. Powell

Available online at <http://repositories.cdlib.org/ucpress/>

**Phylogenetic Relationships
within Heliodinidae and
Systematics of Moths Formerly
Assigned to *Heliodines* Stainton
(Lepidoptera: Yponomeutoidea)**

Yu-Feng Hsu and Jerry A. Powell

**Phylogenetic Relationships
within Heliodinidae and
Systematics of Moths Formerly
Assigned to *Heliodines* Stainton
(Lepidoptera: Yponomeutoidea)**

Yu-Feng Hsu and Jerry A. Powell

UNIVERSITY OF CALIFORNIA PRESS

Berkeley • Los Angeles • London

UNIVERSITY OF CALIFORNIA PUBLICATIONS IN ENTOMOLGY

Editorial Board: Penny Gullan, Bradford A. Hawkins, John Heraty, Lynn S. Kimsey,
Serguei V. Triapitsyn, Philip S. Ward, Kipling Will

Volume 124

UNIVERSITY OF CALIFORNIA PRESS
BERKELEY AND LOS ANGELES, CALIFORNIA

UNIVERSITY OF CALIFORNIA PRESS, LTD.
LONDON, ENGLAND

© 2005 BY THE REGENTS OF THE UNIVERSITY OF CALIFORNIA
PRINTED IN THE UNITED STATES OF AMERICA

Library of Congress Cataloging-in-Publication Data

Hsu, Yu-Feng, 1963–

Phylogenetic relationships within Heliodinidae and systematics of moths
formerly assigned to Heliodines Stainton (Lepidoptera: Yponomeutoidea) /
Yu-Feng Hsu and Jerry A. Powell.

p. cm.

Includes bibliographical references.

ISBN 0-520-09847-1 (paper : alk. paper) — (University of California publications
in entomology ; 124)

1. Heliodinidae—Classification. 2. Heliodinidae—Phylogeny. I. Title. II. Series.

QL561.H44 H78

595.78 22—dc22

2004058800

Manufactured in the United States of America

The paper used in this publication meets the minimum requirements of ANSI/NISO
Z39.48-1992 (R 1997) (*Permanence of Paper*).

Contents

<i>Acknowledgments</i> , ix	
<i>Abstract</i> , xi	
Introduction	1
Problems in Systematics of Heliodinidae and a Historical Review	4
Material and Methods	6
Specimens and Depositories, 6	
Dissections and Measurements, 7	
Wing Venation Preparation, 7	
Scanning Electron Microscope Preparation, 8	
Species Discrimination and Description, 8	
Larval Rearing Procedures, 8	
Phylogenetic Methods, 9	
Phylogeny of Heliodinidae	12
Monophyly of Heliodinidae, 12	
Characters and States Used in the Cladistic Analyses, 13	
Results of Phylogenetic Analyses, 19	
Systematic Account	27
Family Heliodinidae Heinemann, 27	
Key to the Genera of Heliodinidae and Species Groups of <i>Aetole</i> , 29	
Heliodines assemblage, 31	
<i>Heliodines</i> Stainton, 31	
<i>H. roesella</i> (Linnaeus), 32	
Epicroesa assemblage, 35	
<i>Epicroesa</i> Meyrick, 35	
<i>Philocoristis</i> Meyrick, 35	
Lamprolophus assemblage, 36	
<i>Lamprolophus</i> Busck, 36	
Aetole assemblage, 36	
‘Heliodines’ princeps subassemblage, 36	
‘Heliodines’ princeps lineage, 36	
‘Heliodines’ <i>princeps</i> Meyrick, 37	

- Lithariapteryx subassemblage, 38
 - Lithariapteryx* Chambers, 38
 - Neoheliodines* Hsu, new genus, 38
 - Key to species of *Neoheliodines*, 40
 - N. nyctaginella* (Gibson), new combination, 40
 - N. eurypterus* Hsu, new species, 43
 - N. hodgesi* Hsu, new species, 43
 - N. megostiellus* Hsu, new species, 46
 - N. melanobasilarus* Hsu, new species, 47
 - N. vernius* Hsu, new species, 48
 - N. cliffordi* (Harrison and Passoa), new combination, 51
 - N. arizonense* Hsu, new species, 53
 - N. albidentus* Hsu, new species, 55
- Aetole subassemblage, 56
 - Embola* Walsingham, 56
 - Key to species of *Embola* of North and Central America, 58
 - E. ionis* (Clarke), new combination, 59
 - E. ciccella* (Barnes and Busck), new combination, 61
 - E. cyanozostera* Hsu, new species, 63
 - E. albaciliella* (Busck), new combination, 64
 - E. friedlanderi* Hsu, new species, 66
 - E. melanotela* Hsu, new species, 67
 - E. autumnalis* Hsu, new species, 68
 - E. sexpunctella* (Walsingham), new combination, 69
 - E. dentifer* Walsingham, 70
 - E. powelli* Hsu, 71
 - E. xanthocephala* Walsingham, 73
 - Heliogemma* Hsu, new genus, 74
 - H. gigantea* Hsu, new species, 75
 - H. grandis* Hsu, new species, 76
 - H. preclara* Hsu, new species, 77
 - Pseudastasia* Walsingham, 78
 - Euheliodines* Hsu, new genus, 79
 - E. chemsaki* Hsu, new species, 79
 - E. jaliscella* Hsu, new species, 81
 - Aetole* Chambers, revised status, 82
 - Eximia Group, 83
 - A. eximia* Hsu, new species, 84
 - A. insolita* Hsu, new species, 86
 - Bella Group, 87
 - A. bella* Chambers, 88
 - A. schulzella* (Fabricius), new combination, 93
 - A. fulgida* Hsu, new species, 95
 - A. prenticei* Hsu, new species, 96

Tripunctella Group, 99
A. tripunctella (Walsingham), new combination, 101
A. unipunctella (Walsingham), new combination, 103
A. inusitata Hsu, new species, 107
A. aprica Hsu, new species, 108
A. cera Hsu, new species, 108
A. favonia Hsu, new species, 110
Extraneella Group, 111
A. extraneella (Walsingham), new combination, 112
Calcifer Group, 116
A. calcifer (Walsingham), new combination, 117
A. calciferoides Hsu, new species, 119
Galapagoensis Group, 121
A. galapagoensis (Heppner and B. Landry), new
combination, 122
Copocentra Meyrick, 123
Scelorthus Busck, 124
Incertae Sedis, 124
‘*Heliodines*’ *aureoflamma* Walsingham, 124
‘*H.*’ *marginata* Walsingham, 125
‘*H.*’ *urichi* Busck, 126

Biology 127
Larval Host Plant Relationships, 127
Life History, Voltinism, and Diapause, 129
Behavior, 129
Mating, 129
Hind Leg Posture, 130
Oviposition, 130
Larval Biology, 130
Pupal Biology, 131
Summary 133

Tables, 134
Literature Cited, 148
Figures 26–220, 159

Acknowledgments

We are grateful to the following for assistance in field work, comments on the manuscript, the loan of specimens, and other contributions: John Brown, Systematic Entomology Laboratory, USDA, U.S. National Museum of Natural History, Washington, D.C.; John Chemsak, Essig Museum of Entomology, University of California, Berkeley; David Furth, formerly at the Museum of Comparative Zoology, Harvard University, Cambridge; Reinhard Gaeike, Deutsches Entomologisches Institut, Eberswalde; Terry Harrison, University of Illinois, Urbana; John Heppner, Florida State Collection of Arthropods, Gainesville; Ronald Hodges, Eugene, Oregon, formerly USDA, U.S. National Museum of Natural History, Washington, D.C.; Niels Kristensen, University of Copenhagen, Universitetsparken; Bernard Landry, Muséum d'histoire naturelle, Geneva; Jean-François Landry, Canadian National Collection, Ottawa; Martin Lodl, Naturhistorisches Museum Wien, Vienna, Austria; Carolina Martin, Museo Nacional de Ciencias Naturales, Madrid, Spain; Scott Miller, formerly of the Bishop Museum, Honolulu, Hawaii; Sigeru Moriuti and Toshiya Hirowatari, University of Osaka Prefecture, Sakai, Japan; Norman Penny, California Academy of Sciences, San Francisco; Michael Prentice, Jorge Santiago-Blay, and Robert Zuparko, University of California, Berkeley; Edward Riley, Texas A.&M. University, College Station; Michael Shaffer, Natural History Museum, London; Frederick Stehr, Michigan State University, East Lansing; David Wagner, University of Connecticut, Storrs; Shen-Horn Yen, Imperial College at Silwood Park, Ascot. Brown and Harrison provided detailed critical reviews of the manuscript that were exceptionally useful. Many plant identifications were made by Barbara Ertter, UC Herbarium, which retains the voucher specimens. YFH is especially indebted to John Doyen and Thomas Duncan, University of California, Berkeley, for many helpful comments and suggestions and Christopher Meacham and Brent Mishler for assistance with cladistic analysis. Finally, we are indebted to Gordon Nishida, who prepared the illustrations in electronic format, and provided other computer expertise enabling completion of the final copy.

Abstract

Heliodinidae traditionally have been characterized on the basis of forewing venation, color and scaling, and perch behavior, but none of these attributes defines monophyly. We identify four uniquely derived autapomorphies for the family: (1) M vein of forewing two-branched, presumably with M3 lost; (2) tegumen greatly expanded posteriorly, forming a sclerotized, hollow tube; (3) ventral branches of apophyses anteriores originating from a fused transverse bridge; and (4) pupa with long, stiff dorsal and lateral setae. Phylogenetic relationships among genera and species groups of world Heliodinidae are constructed using parsimony and character compatibility as optimality criteria, with representatives of six other families of Yponomeutoidea as outgroups. Results of the analyses show *Heliodines* Stainton, as formerly recognized (i.e., all the species with conspicuous red markings on the forewings), to be a polyphyletic assemblage. To accommodate the New World fauna, two old names, *Aetole* Chambers and *Embola* Walsingham, have been resurrected from synonymy, and three new genera are described: *Neoheliodines* Hsu (Type species: *Heliodines nyctaginella* Gibson, 1914), *Heliogemma* Hsu (Type species: *H. gigantea* Hsu), and *Euheliodines* Hsu (Type species: *E. chemsaki* Hsu). The South American genus *Cremlastis* Meyrick is synonymized with *Embola*. A descriptive taxonomy is provided for North and Central American and Caribbean species formerly assigned to *Heliodines*; 45 species are treated, 25 of which are described as new: *Aetole fulgida* (TL: Sinaloa, Mexico), *A. prenticei* (Calif.), *A. eximia* (Baja Calif., Mexico), *A. insolita* (El Salvador), *A. cera* (Calif.), *A. favonia* (Calif.), *A. inusitata* (Baja Calif., Mexico), *A. aprica* (Texas), *A. calciferoides* (Veracruz, Mexico); *Embola autumnalis* (Ariz.), *E. cyanozostera* (Nevada), *E. friedlanderi* (San Luis Potosí, Mexico), *E. melanotela* (Haiti); *Euheliodines chemsaki* (S. L. P., Mexico), *E. jaliscella* (Jalisco, Mexico); *Heliogemma gigantea* (Jalisco, Mexico), *H. grandis* (Tamaulipas, Mexico), *H. preclara* (Jalisco, Mexico); *Neoheliodines albidentus* (Ariz.), *N. arizonense* (Ariz.), *N. eurypterus* (Ariz.), *N. hodgesi* (Ariz.), *N. megostiellus* (Jalisco, Mexico), *N. melanobasilarus* (San Luis Potosí, Mexico), *N. vernius* (Calif.). The remaining genera of Heliodinidae *s. str.* are listed, and we provide diagnoses, illustrations of genitalia for representative species, literature references, and a list of described species. Adults of many Heliodinidae hold their hind legs elevated above the body when perched, which has been regarded as characteristic of the family. However, it is neither limited to heliodinids nor common to all of them. All species of *Aetole* and *Scelorthus* and some species of *Embola* and *Copocentra* hold the legs elevated, while observed members of other genera do not. The function of this behavior is uncertain. Larval host plants are recorded for 33 species (14 newly discovered during this study), about 45% of the described world fauna; 30 (90%) of these are specialists on Caryophyllales, especially Nyctaginaceae. The remaining three are members of three unrelated

genera, and they feed on plants in three orders (Piperales, Apiales, and Myrtales). Phylogenetic analyses indicate these are derived adaptations from a Caryophyllales-feeding ground plan.

INTRODUCTION

Heliodinidae are small, characteristically metallic-colored, diurnal Microlepidoptera classified in the superfamily Yponomeutoidea (Lepidoptera, Ditrysia). Yponomeutoidea, combined with three other superfamilies, Tineoidea, Gracillarioidea, and Gelechioidea, form the basal lineages of ditrysiian moths to the more derived, vast apoditrysiian lineages (Minet 1991). Heliodinidae occur worldwide (Table 1) but are much more diverse in the Western Hemisphere. Of the 72 described species, only nine (12%) are Old World. Central and South America probably harbor a large, not yet investigated diversity of these small moths.

This study began in 1990 as a systematic revision of the genus *Heliodines* Stainton. In addition to outgroup genera in several other families of Yponomeutoidea, we included in the phylogenetic analysis seven other genera that were regarded as comprising the Heliodinidae *s. str.* worldwide, which we thought would establish relationships of *Heliodines*. The existing genus '*Heliodines*,' however, proved to be polyphyletic with respect to the other described genera, and the title "species formerly assigned to *Heliodines*" evolved as a result. Hence the coverage of the systematics section (the descriptive taxonomy) does not include the non-'*Heliodines*' genera. We provide diagnoses, illustrations of genitalia, and literature references for the other genera.

Had this study been initiated to encompass all Heliodinidae worldwide, there would have been a monumental problem in tracking down types of all names assigned to the family and eliminating those that should be included in other families. This is because nearly all the genera were described during an era (1860-1960) when the Heliodinidae consisted of a diverse conglomeration that included stathmopodine Oecophoridae, chrysoesthiine Gelechiidae, and Schreckensteiniidae, which is now placed in Apoditrysia. Many are monobasic, single specimen taxa for which type specimens are not available. Ten genera were transferred to other taxa by Kasy (1976) and Heppner (1982), and since we began work the problem has been further resolved by Kyrki (1990) and Nye and Fletcher (1991), who transferred about 40 more genera from Heliodinidae to Yponomeutoidea or Gelechioidea, unplaced to family, on the basis of opinions from J. Minet and the late J. Kyrki. There are 14 genera that remain unverified in Heliodinidae (Table 1, Appendix), and we assume this was a default stance by Nye and Fletcher; that is, these genera could not be placed by Minet or Kyrki based on the descriptions.

We believe most of these 14 genera are not Heliodinidae according to present definition, but the relevant diagnostic characters were not described, and without study of dissections of the types, we cannot place them. The fundamental conclusion regarding polyphyly of '*Heliodines*' certainly would not have been affected by inclusion of any of these genera.

The fossil record of Heliodinidae is scarce and probably too recent to be meaningful for inferring anything about heliodinid phylogeny. Skalski (1976) reported one undescribed species from Baltic amber, which was represented by more than 20 specimens. The specimen he illustrated has wing venation similar to that of the extant European species, *Heliodines roesella* (L.) but has broader wings and apparently a larger body, although that could be due to fungal growth or other inclusions. Later, Kristensen and Skalski (1998) reported that more than 70 specimens of this species are known.

Although the magnificent, metallic colors of the heliodinids show remarkable diversity, our analysis indicates that color patterns usually do not correlate with the phylogenetic relationships among cladistic lineages. The majority of known heliodinid species have bright orange or red ground colors on the forewings, and as a consequence of superficial resemblance, these orange or red moths were lumped into the genus *Heliodines* Stainton, which we find to be polyphyletic.

The life history and larval habits of heliodinids are diverse. Each species exhibits a specific feeding strategy. Rarely do two sympatric species use the same feeding strategy on the same host plant. Heliodinids inhabit a great variety of environments including serpentine grasslands, freshwater and brackish marshes, arid lands, chaparral, subtropical hammocks, subtropical deciduous forests, and tropical forests. However, heliodinids usually are locally colonial and found only in the vicinity of their larval hosts.

The systematics of Heliodinidae can be described as rudimentary. An important factor that has inhibited taxonomic progress on these moths has been the difficulty in collecting adequate material. Adults come to flowers and a few species to lights, but their activities often are restricted to the near vicinity of the larval hosts. There are two problems: (1) heliodinids are liable to be overlooked if host plants are not searched by specialists; and (2) general collectors do not collect specimens in adequate condition, even if they see them, because of the small size, delicate structure, and need for special handling. The most reliable method to obtain research material of heliodinids is to learn their larval host associations, and this was not done systematically in the past.

The systematics of the Heliodinidae formerly relied on characters of wing venation. Presence and absence of certain veins were employed to define the relationships among heliodinid groups, but the presence and absence of veins are fairly homoplasious among heliodinid taxa.

Elevation of the hind legs of the adults in repose (Fig. 152) was regarded as a diagnostic character for the family Heliodinidae (e.g., Meyrick 1914b, Diakonoff 1968, Kasy 1976). However, this behavior occurs in at least three lineages: Heliodinidae, stathmopodine Oecophoridae, and Schreckensteiniidae, which are classified in three superfamilies (Common 1990, Scoble 1992), and many heliodinids do not raise their hind legs (Fig. 153).

Heliodinids possessing broad wings, unlike the typical lanceolate wings, were placed in families such as Plutellidae (Meyrick 1907) and Glyphipterigidae (Meyrick 1913, 1914a, 1927).

The goals of this work are (1) to review all the described Heliodinidae *s. str.*, with special reference to the superficially similar, orange and red species formerly assigned to the genus *Heliodines*, which included more than half of the known species; (2) to provide a cladistic analysis of all of the recognized lineages, using morphological characters of adults and immature stages; (3) to define major supraspecific taxa that best reflect phylogenetic relationships; and (4) to provide a descriptive taxonomy for the species formerly assigned to *Heliodines*.

This study encompasses a worldwide treatment of the genera and species groups of Heliodinidae and provides species-level systematics for moths formerly assigned to *Heliodines* in North and Central America. Species from the Greater Antilles are treated in the descriptive taxonomy because they may be found in southern Florida. Species restricted to the Lesser Antilles are excluded from the descriptive taxonomy because they are affiliated with South America. Caribbean records of species that also are found on mainland North and Central America are included. A few species from other regions are treated because they represent species- or generic-groups that do not occur in North or Central America (e.g. Galapagoensis Group of *Aetole*).

A major obstacle was the rarity of specimens in collections. The effect of this problem was particularly severe when a unique specimen represented a species that is the sole member of a distinct group. Fortunately, we have been able to rectify most such problems in the North and Central American fauna through productive fieldwork. In a few such situations, however, we were forced to exclude species from the cladistic analysis.

The biologies of some distinct groups are completely unknown, and this rendered a gap in the data set for the phylogenetic analysis. The phylogeny presented here for Heliodinidae can be improved when biologies of the problematic groups become known.

We hope our work will establish a ground for further tests on the evolutionary history of Heliodinidae and inspire investigations into the biology and biodiversity of these intriguing moths.

PROBLEMS IN SYSTEMATICS OF HELIODINIDAE AND A HISTORICAL REVIEW

The major problems in systematics of Heliodinidae have been (1) lack of modern revisionary work for the majority of heliodinid groups; (2) difficulty in identifying and recognizing species using existing descriptions, because most known species were described before 1940 when genitalia rarely were described or illustrated; and (3) erroneous assignments of species to higher-level taxa because of similarity in appearance of remotely related species.

Heliodinidae was not recognized as a family until Heinemann (1877). Before 1877 Heliodinidae were placed in either "Tineina" (e.g., Chambers 1875, 1876) or Elachistidae (e.g., Stainton 1854, 1859). Before 1910 most of the taxonomic information on Heliodinidae had been in the form of scattered descriptions of genera and species, notably by Busck, Meyrick, and Walsingham. Comments on relationships of various groups of heliodinids to the European *Heliodines roesella* (L.), the type species of *Heliodines*, and a few other genera were made by Meyrick (1906) and Walsingham (1881, 1909). Documentation of the biology began in the early period (e.g., Stainton 1859, Walsingham 1897).

Busck (1910a) compiled a key to the heliodinid species of North America. All seven species treated are true heliodinids, and Busck presented a good summary of the external diagnostic characters of species. Meyrick (1913, 1914b) published catalogs of the Heliodinidae and a comprehensive revision of the family. Although Meyrick included many non-heliodinids, he covered the known information on higher-level taxonomy of Heliodinidae and compiled a species catalog. These publications offer invaluable information on external characters and biology.

Monte (1934) and Lima (1936) reported on the biology of *Embola dentifer* Walsingham from Brazil, the first biological observations of a heliodinid in South America. Lima (1945, 1968) changed his identification of the moth to *Lamprolophus obolarcha* Meyrick, but the identity of the species in these older reports remains unverified. Pierce and Metcalfe (1935) provided the first drawings of the genitalia of both sexes of the European *Heliodines roesella*. Comstock (1940) studied Californian *Lithariapteryx* Chambers, described two species, and gave an account of their early stages. Turner (1941) published a revision of the Australian Heliodinidae, but he included only one species of Heliodinidae as defined today, *Heliodines princeps* Meyrick.

Little was published on heliodinids from the 1940s through the 1960s except brief biological accounts of the European *H. roesella* (Lhomme 1948, Hruby 1964) and of some species in the United States (Clarke 1952, Kimball 1965, Wester 1956). Clarke's (1952) *H. ionis* was the only North or Central American species to be described during this period. Clarke (1955) published a catalog of microlepidoptera described by Meyrick, including his heliodinid species. Unfortunately, Clarke excluded Heliodinidae from his subsequent atlas of type specimens that included illustrations

of genitalia.

Karsholt and Nielsen (1976) attempted to solve nomenclature problems in some Lepidoptera taxa described by Linnaeus, Fabricius, and Strom. This work resolved a problem in the European *Heliodines roesella*. Three specimens were represented in the type series of *H. roesella*, two of which are *H. roesella*. The other is a specimen of *Chrysoesthia drurella* (Fabricius) (Gelechiidae). Karsholt and Nielsen selected a lectotype and stated that the biological note in the original description of *H. roesella* should refer to *Phyllonorycter blancardella* (Fabricius) (Gracillariidae).

Diakonoff and Arita (1979) described a new species of *Epicroesa* Meyrick from Japan and correctly transferred that genus to Heliodinidae from Glyphipterigidae. Heppner's (1982) world catalog of "Glyphipterigidae Auctorum" provided a review of heliodinids that had been assigned incorrectly to Glyphipterigidae. Heppner (1984, 1987) compiled a checklist of the described Neotropical heliodinids and illustrated the chaetotaxy of heliodinid larvae of two North American genera.

In the 1980's there was extensive discussion of the higher classification of ditrysian Lepidoptera. Kyrki (1983, 1984, 1990) contributed significantly to our understanding of the systematics of Yponomeutoidea, and Minet (1983) removed the genus *Schreckensteinia* Hübner from Heliodinidae to its own superfamily in Apoditrysia. The status of families and superfamilies was summarized by Scoble (1992).

Recently there has been renewed interest in the systematics of heliodinids, with modern treatments including illustrations of genitalia and biological information of European, American, and Australian species (e. g., Emmet 1985, Nielsen and Common 1991, Common 1990, Fal'kovich 1990). Powell (1991) contributed a review of the Nearctic genus *Lithariapteryx*, with comprehensive information on the biology of the four species, including one newly described. Heppner and Landry (1994) described a bizarre new species from the Galapagos Islands, and Harrison and Passoa (1995) provided detailed treatments on four species from Illinois, one of which was described as new.

MATERIALS AND METHODS

SPECIMENS AND DEPOSITORIES

We examined more than 1,800 specimens of adult Heliodinidae and more than 200 larval and pupal specimens preserved in ethanol. The Essig Museum of Entomology, University of California, Berkeley, holds the largest collection of heliodinids (about 55% of the total), followed by the U.S. National Museum of Natural History, Washington, D.C. (USNM, about 20%). The Natural History Museum, London, and USNM house most of the primary types of previously described heliodinids. The institutions where specimens are deposited are listed below.

ANIC Australian National Insect Collection, C.S.I.R.O. Division of Entomology, Canberra City, Australia.

BMNH Department of Entomology, The Natural History Museum, London.

BPBM Bernice P. Bishop Museum, Honolulu, Hawaii, U.S.A.

CAS California Academy of Sciences, San Francisco, U.S.A.

CNC Canadian National Collection, Biosystematics Research Centre, Agriculture Canada, Ottawa, Ontario, Canada.

DEI Deutsches Entomologisches Institut, Eberswalde, Germany.

FSCA Florida State Collection of Arthropods, D.P.I, Gainesville, U.S.A.

LACM Natural History Museum of Los Angeles County, Los Angeles, U.S.A.

MNCN Museo Nacional de Ciencias Naturales, Madrid, Spain.

MSU Department of Entomology, Michigan State University, East Lansing, U.S.A.

MCZ Museum of Comparative Zoology, Harvard University, Cambridge, U.S.A.

NHMW Naturhistorisches Museum Wien, Vienna, Austria.

SDNHM San Diego Natural History Museum, San Diego, U.S.A.

TAMU Department of Entomology, Texas A.& M. University, College Station, U.S.A.

UCB Essig Museum of Entomology, University of California, Berkeley, U.S.A.

UCONN Department of Ecology and Evolutionary Biology, University of Connecticut, Storrs, U.S.A.

UOPS Entomological Laboratory, College of Agriculture, University of Osaka Prefecture, Sakai, Japan.

USNM Department of Entomology, U.S. National Museum of Natural History, Smithsonian Institution, Washington, D.C., U.S.A.

ZMUC Zoological Museum, University of Copenhagen, Denmark.

All primary types of confirmed heliodinid species were examined, except for *Heliodines aureoflamma* Walsingham from the West Indies, which we were unable to locate. Non-heliodinid taxa and those of unrecognized systematic placement that have been treated as Heliodinidae in recent publications are listed in the Appendix to table 1 and are excluded from this study.

DISSECTIONS AND MEASUREMENTS

Genitalic preparations were made by a modification of techniques described by Brown and Powell (1991) and are summarized as follows.

The abdomen is removed by applying slight pressure to the venter using a probe and is placed in a solution of 10% KOH for 16 to 24 hours. Then the abdomen is transferred to water, and the macerated viscera are removed by flattening the abdomen dorsoventrally with a spatulate tool and flushing with a fine syringe. After this initial cleaning, the abdomen is placed in cellusolve (Dowanol EE; $C_2H_5OC_2H_4OH$) for another 24 hours, and the scales and remaining viscera are cleaned with a pair of slender bird feathers. For females, a longitudinal incision is made along the left pleuron (ventral aspect). The genital capsule is then removed from the pelt by tearing the A6-7 intersegmental membrane for females and by pulling the capsule free at the A8-9 membrane using fine forceps or a probe with bent tip for males. The abdominal integument and genital capsule then are stained in a weak solution of chlorazol black for several minutes. All items are washed in 95% ethanol and the phallus is removed. Valvae of the male are spread in xylene and fixed in position by overlaying a small piece of glass onto the genitalia for about five minutes. After staining, female genitalia were transferred back to cellusolve, then directly to a Canada balsam slide mount. Spacers can be used to support the cover slip when the size of genitalia is relatively large but are not necessary for heliodinids.

Unfortunately, the unique type males of several species in the BMNH had been dissected prior to our study and mounted laterally on slides, with the phallus in situ. We were able to examine and illustrate them only in this posture, so the drawings and SEM photos are difficult to compare with ventral aspect slides for several characters.

Measurements were made using an optical micrometer mounted in an AO dissecting microscope. Forewing length was measured along a straight line from base to apex. A representative sample of 30 specimens was measured for each sex of each species or, if fewer, of all specimens available. Range and mean of measurements were calculated. When sample size was smaller than three, no mean was calculated. Measurement of *socii* was taken from the base to the apex. Length of tegumen was taken excluding the *socii*. Length of the saccus was defined as the distance from the distal tip to the junction of the saccus and tegumen.

WING VENATION PREPARATION

Microscope slides for examining wing venation were prepared by a modification of the technique by I. F. B. Common, summarized as follows. Wings were detached by applying pressure near the base of wings with a fine forceps. The wings were then placed in a 10% KOH solution for about two hours, transferred to water, and washed. After immersion in cellusolve for about 24 hours, the wings were descaled using a pair of bird feathers. Descaled wings were washed in distilled water before transfer to a solution of acid fuchsin (10 g of chloral hydrate dissolved in 5 ml glacial acetic acid + 1 g of acid fuchsin powder, then 95 ml of 50% ethanol added) for staining for

about 24 hours. Wings were removed from the stain and washed in 95% ethanol briefly — the stain is highly soluble in water — before transfer to 100% ethanol. The wings were then transferred to xylene and slide mounted in a thin layer of Canada balsam.

SCANNING ELECTRON MICROSCOPE PREPARATION

Parts were glued onto a solid aluminum cylinder with silver paint. Glued parts were sputter coated with two 30 nm layers of gold (Polaron, SEM coating system), specimens were rotated 90° after the first application. Sputter-coated samples were examined using an ISI DS-130 SEM at 10 to 15 KV.

SPECIES DISCRIMINATION AND DESCRIPTION

We adopt Wiley's (1981) evolutionary species concept. Evolutionary identity and reproductive isolation were inferred on the basis of morphological discontinuities. Genitalic differences were given higher weight in species recognition over color patterns of wings and body. A single consistent distinguishing genitalic character was considered sufficient to indicate species distinction. Specimens with clinal variation in color patterns and genitalic features were considered conspecific. A nomenclatural subspecies concept was not employed in this study.

Wing venation nomenclature follows that of Common (1990). Terminology for characters of the genitalia follows Klots (1970). Chaetotaxy follows Stehr (1987). The typical lead- or silver-colored forewing spots are numbered from the base toward the apex, in costal (C1, C2, etc.) and dorsal margin (D1, D2, etc.) series. Color names used in the descriptions are those summarized by Smithe (1975).

Abbreviations are as follows: FW = forewing; HW = hindwing; C = costal; D = dorsal; A = abdominal; > = larger than; < = smaller than; ≥ = larger than or equal to; ≤ = smaller than or equal to.

LARVAL REARING PROCEDURES

Previously unknown host plants of heliodinid species were sought by examining plants in the habitats where the adults were found. After the realization that most heliodinids specialize on plants in the Order Caryophyllales, plant specimens in the University of California, Berkeley, Herbarium were checked for evidence of larval feeding. In some cases mines or feeding scars and frass of heliodinids were found on plant specimens, which directed the geographical and botanical focus of subsequent field investigations, leading to the discovery of several previously unknown heliodinids and their host plants.

Immatures collected in the field were placed in polyethylene bags in a camp ice chest to prevent desiccation and overheating during transportation. Large collections of larvae (> 10 larvae) were placed in plastic bags with double paper towel beneath the vegetation containing immatures for rearing. Small collections (< 10 larvae) were

placed in 8- or 16-ounce plastic cups or 20- or 40-dram plastic vials with tissue paper.

When the number of immatures of a given collection was reasonably large, some larvae and/or pupae were preserved. The larva or pupa was placed in boiling water until expansion, then preserved in 70% ethanol.

PHYLOGENETIC METHODS

Phylogenetic reconstruction follows the principles and methods of cladistic analysis (Hennig 1966, Ashlock 1974, Duncan 1980, Wiley 1981).

Selection of Ingroup Operational Taxonomic Units (OTUs). After all available specimens were examined, dissections made, and a list of characters and their states compiled, ingroup OTUs (genera and species groups) were defined as follows: Selection and definition of species membership followed criteria defined by Vrana and Wheeler (1992) and Mishler and Theriot (2000); that is, species were defined initially by grouping together specimens that are homogeneous for the character states then known. In many instances we also had substantial evidence based on field collections of larvae of larval behavior, host plant associations, and geographical and habitat patterns. For described genera other than *Heliodines*, we used the type species plus specimens representing all available described species. For species formerly assigned to *Heliodines*, initially species that shared few character states with other heliodinid species and/or showed unusual host plant associations (non-Nyctaginaceae) were assigned as separate OTUs (e.g., *extraneella* Walsingham). Described and undescribed species that shared uniquely derived character states were clustered together and given the status of multiple species groups, identified by number designation (e.g., groups later treated as *Neoheliodines* Hsu, *Heliogemma* Hsu, and the *Eximia* Group of *Aetole* Chambers).

Selection of Outgroups. The selection of outgroups followed the criteria of Maddison et al. (1984). Nine species representing six yponomeutoid families sensu Kyrki (1990) were used: *Bedellia somnulentella* (Zeller) (Bedelliidae); *Lyonetia candida* Braun (Lyonetiidae); *Glyphipterix bifasciata* Walsingham and *G. feniseca* Heppner (Glyphipterigidae); *Plutella albidorsella* Walsingham, *P. dammersi* Busck, and *P. xylostella* (L.) (Plutellidae); and *Ypsolopha cervella* (Walsingham) (Ypsolophidae). *Ypsolopha* Latreille traditionally has been included in Plutellidae but was treated as a separate family by Kyrki (1990). In addition, *Acrolepiopsis californica* Gaedike (Acrolepiidae) was treated as a sixth outgroup. Acrolepiinae is regarded as a subfamily of Plutellidae by Kyrki (1990), but it was treated as an independent OTU in this study because Heppner (1987) suspected Acrolepiidae to be the sister group of Heliodinidae. Specimens of outgroup species were from California, although *B. somnulentella* and *P. xylostella* are introduced, presumably from Europe. In parsimony analysis, the six outgroups were combined with the ingroup OTUs in the search for the most parsimonious solution.

Species known only from unique type specimens that presumably represent monotypic genera were excluded from the phylogenetic analyses because realistic

placement requires characters of both sexes. The following species are listed in Table 1 but were omitted from our phylogenetic analysis: the sole Afrotropic supposed heliodinid representative, *Hierophanes* Meyrick, with the monobasic type species, *H. chrysocrana* Meyrick, described from Uganda, known only from a unique female; '*Heliodines*' *marginata* Walsingham, known from one male; and '*H.*' *urichi* Busck, known from one female. Although excluded from the phylogenetic analyses, both of the latter are redescribed and illustrated. We were unable to locate the unique type of '*H.*' *aureoflamma* Walsingham, which is in Romania (M. Shaffer, in litt.).

In addition to the described species formerly assigned to *Heliodines*, four unique female heliodinid specimens, each possessing a distinct genitalia type, were not included in the analyses: one from the British Virgin Islands (YFH slide 0972, USNM), one from Hidalgo, Mexico (EME slide 3843, UCB), one from Heredia, Costa Rica (YFH slide 0936, INBio), and one from Douglas County, Nevada, U.S.A. (EME slide 3800, UCB).

Crembalastis Meyrick was not regarded as an independent OTU because this genus agrees with *Embola* Walsingham in all character states and is considered a subjective synonym of *Embola*.

The data set for the cladistic analyses (Table 2) employed 36 morphological and behavior characters of 19 heliodinid ingroup OTUs and six yponomeutoid outgroups (Table 3). A parsimony analysis was performed using Swofford's PAUP 3.1.1 program (Swofford 1991) and a Macintosh microcomputer. Global branch swapping and the MULPARS option were employed (Swofford 1991). Polarities of two-state characters were determined by outgroup comparison (Stevens 1980). Multistate characters were left unordered. After an initial analysis, characters were weighted *a posteriori* using Farris' (1969) successive approximations approach, in which weights are based on the fit of the characters to the trees (CI values). Then a second analysis was performed.

A subset of four yponomeutoid outgroups (Bedelliidae, Lyonetiidae, Plutellidae, and Ypsolophidae sensu Kyrki 1990) was selected for another run of the parsimony analysis using the procedures described above, serving as a test of the results of the first analysis. All the yponomeutoid outgroups were then removed. The most basal lineage determined from the first and second analyses was treated as a hypothetical outgroup, and another run of the parsimony analysis was made. Consensus trees were generated after the shortest trees were calculated.

The data set (Table 3) used in the parsimony analysis was modified for the compatibility analysis demonstrated by Duncan (1980) and Meacham (1981) as an independent test in the phylogenetic reconstruction: (1) outgroups and characters 32 through 36, which were used to maintain the monophyly of the ingroups, were excluded; (2) missing data and within-OTU multistate characters were replaced by values interpreted in the parsimony analysis; (3) multistate characters were transformed into character state tree lines; and (4) character 31, larval feeding behavior, was excluded because of its presumed homoplasious nature; this character was also excluded from the parsimony analysis. The modified data set is shown in Table 4; the character tree line list is shown in Table 5. The compatibility analysis

was performed using Fiala's (1984) CLINCH program and an IBM-PC microcomputer. The classification was derived from the cladograms produced by the phylogenetic analyses.

PHYLOGENY OF HELIODINIDAE

MONOPHYLY OF HELIODINIDAE

Systematists have relied largely on forewing venation, color and scaling on forewing and legs, and perching behavior to characterize heliodinids. These features, however, are not unique to the family and have been misinterpreted. Consequently, members of non-heliodinid moths have been placed in the family, while certain heliodinids have been placed in other families such as Glyphipterigidae. Although these features enable confident recognition of most members of the family, they are not appropriate for cladistic definition of Heliodinidae.

Many of the traditionally emphasized external characters turn out to be useless in characterizing membership in Heliodinidae. Two especially notable ones are whorls of bristles at the distal end of the tibia and elevated hind legs in repose (Meyrick 1914b). The so-called bristles at the distal end of the tibia are actually linear-shaped scales (Figs. 159, 160) that are absent in many species. The elevation of the hind legs is expressed by some heliodinids (Fig. 152) but not by others (Fig. 153).

Kyrki (1984, 1990) proposed a phylogenetic hypothesis of the superfamily Yponomeutoidea. Four characters were listed by Kyrki (1984) as possible autapomorphies for Heliodinidae: (1) smooth scaling on the head (Figs. 154-156), a feature also found in Glyphipterigidae, but the scaling of glyphipterigids is not tightly appressed as in heliodinids; (2) vein CuP absent from the forewing (Figs. 26-43), but this state is also encountered in Lyonetiidae and Bedelliidae *sensu* Kyrki (1990), possible sister groups of Heliodinidae; (3) strong lateral ridges on the pupa (Figs. 164-167), but Kyrki (1990) pointed out that this state is actually a synapomorphy shared by Heliodinidae, Lyonetiidae, and Bedelliidae; and (4) stiff, long lateral and dorsal bristles on the pupa (Figs. 163-172), a uniquely derived structure of Heliodinidae found in no other Yponomeutoidea.

Three additional characters are proposed here as autapomorphies of Heliodinidae.

1) Apophyses anteriores with ventral branches originating from a fused medial sclerotized band forming a bridge between them (Fig. 58). All other Yponomeutoidea except Lyonetiids *sensu* Kyrki (1990) and certain yponomeutids have the ventral branches originating separately. Lyonetiidae have the ventral branches highly modified, forming a transverse bridge connecting with the ostium bursae (Kuroko 1982), a very different form from that in Heliodinidae. This modification is considered to have originated independently from the fused ventral branches in Heliodinidae. The fusion of the ventral branches also occurs in some Yponomeutidae (Friese 1962), but two prominent lobes are still recognizable, unlike the single piece found in heliodinids.

2) Tegumen enormously expanded posteriorly, forming a conical or tubular sclerotized, hollow sac (Figs. 57, 161-162). This structure is deeply divided dorsally in some species.

3) M veins of forewing two-branched (Figs. 26-43), with M3 presumably lost. The taxonomic value of this character was noticed by Forbes (1923), who regarded it as a generic level character to distinguish *Heliodines* from a cluster of genera no longer viewed as heliodinids today. The venation shown by Emmet (1985) as “*Heliodines* spp. (after Wedgbrow)” clearly is not of a heliodinid; it has 3 M veins on the forewing.

Two of Kyrki's (1990) four characters (numbers 1 and 4 above) plus the three additional autapomorphies of Heliodinidae identified here were included as characters 32 through 36 in the data matrix for the cladistic analysis to affirm the monophyly of Heliodinidae from the yponomeutoid outgroups.

CHARACTERS AND STATES USED IN THE CLADISTIC ANALYSIS

The characters used for the cladistic analysis are listed in Table 2 and discussed below.

Character 1. Forewing veins R4 and R5. Two states are recognized: (0) separate (Figs. 27-33, 35-36, 38, 40, 42-43); (1) stalked proximally (Figs. 26, 34, 37, 39, 41). The proximal fusion of veins R4 and R5 was noted by Stainton (1854), who proposed the genus *Heliodines* based on the European species, *H. roesella*. The usefulness of this state to define relationships between heliodinid species has been discussed by Walsingham (1881, 1909), Gibson (1914, quoted from discussion with Busck), and Forbes (1923). However, its importance was questioned by Meyrick (1906) and Powell (1991) because both character states are shown even in related groups. In our cladistic analysis the character is shown to be highly homoplasious, with both states found in unquestionable sister group pairs such as the Tripunctella and Extraneella Groups of *Aetole*. As a consequence, this character offers no resolution to higher level phylogenetic relationships in Heliodinidae.

Character 2. Forewing vein Cu2. Two states are recognized: (0) present (Figs. 26-33, 35, 43); (1) absent (Figs. 34, 36-42). The absence of vein CuA2 of the forewing in some heliodinids was first shown by Chambers (1880) for *Aetole bella* Chambers. That illustration was based on misidentified ‘*H.*’ *tripunctella* Walsingham, but both *A. bella* and *A. tripunctella* have CuA2 missing from the forewing and hindwing. Walsingham (1881) suspected that Chambers had overlooked the vein because he considered *A. bella* to be closely related to *Heliodines roesella*, which has a CuA2 vein. Later Walsingham (1909) considered the absence of the forewing CuA2 a useful taxonomic character and included it in diagnoses for several heliodinid genera that he proposed. Forbes (1923) mentioned the loss of CuA2 in North American ‘*H.*’ *nyctaginella* Gibson was in error; *nyctaginella* possesses a CuA2 vein.

The majority of the basal groups of heliodinids and yponomeutoid outgroups have CuA2 in the forewing, and the possession of this vein seems to be the ground plan state for Heliodinidae. Loss of forewing CuA2, while somewhat homoplasious, occurs in some closely related lineages, indicating it could be a synapomorphy for certain clades.

Character 3. Hindwing vein CuA2. Two states are recognized: (0) present; (1) absent. The absence of vein CuA2 from the hindwing of some heliodinids also was illustrated by Chambers (1880) for *Aetole bella* (a misidentification as discussed in character 2) and by Walsingham (1881) without comments on its value to heliodinid systematics. Walsingham (1909) and Busck (1910a) included this character state in diagnoses for several heliodinid genera.

The presence of CuA2 is considered the plesiomorphic state in heliodinids because it occurs in the majority of basal lineages of heliodinids as well as in outgroups. The loss of CuA2 in the hindwing is usually but not always correlated with the loss of the forewing CuA2.

Character 4. Forewing veins M1 and M2. Two states are recognized: (0) separate (Figs. 26, 29-43); (1) stalked proximally (Figs. 27-28). Stalked M veins are encountered only in the *Philocoristis/Epicroesa* lineage of the western Pacific regions, evidently a synapomorphy of this lineage.

Character 5. Frenulum of female. Three states are recognized: (0) double, symmetrical (Fig. 35); (1) double, asymmetrical, with one bristle shorter than the other (Figs. 26-29); (2) single (Figs. 30-34, 36-43). Variation in the female frenulum in Heliodinidae was overlooked in the past. The single bristle condition is listed as a family level character for Heliodinidae by Nielsen and Common (1991). The symmetrical, double frenulum (state 0) is found predominantly in Yponomeutoidea other than Heliodinidae; therefore, it is believed to represent the ground plan. Among Heliodinidae, this state occurs in the *Euheliodines* lineage, which shares synapomorphies with a few more advanced lineages. We interpret the symmetrical, double frenulum condition as a reversal within this lineage.

The asymmetrical, double frenulum (state 1) occurs in basal lineages of heliodinids, indicating this state is more likely plesiomorphic than the single frenulum condition (state 2).

Character 6. Forewing plane. Two states are recognized: (0) flat or barely bent at apex; (1) distal half of forewing bent ventrad. In species of the *Philocoristis/Epicroesa* lineage, the distal half of the forewing droops along the distal end of the discal cell, a synapomorphy for this lineage.

Character 7. Shape of scaling behind eyes. Two states are recognized: (0) linear, narrow, long, visible externally (Figs. 154-155); (1) oblong, broad, short, not visible externally (Fig. 156). The elongate linear type of scales is present in all yponomeutoid outgroups and all basal lineages of heliodinids. Although a reversal is hypothesized at the Calcifer/Galapagoensis Groups of *Aetole*, the short oblong scale type is constant in the other *Aetole* Groups, representing a synapomorphy.

Character 8. Shape of antenna. Two states are recognized: (0) cylindrical filiform (Figs. 173-196, 201-219); (1) flattened dorsoventrally (Figs. 197-200). The cylindrical filiform antenna is found in all outgroups and the majority of heliodinid ingroups, while the flattened, enlarged state occurs in *Pseudastasia* Walsingham and *Heliogemma*, suggesting that it is a synapomorphy for these two genera.

Character 9. Shape of pleural lobes of A8 in male. Three states are recognized: (0) weakly sclerotized (Figs. 44-46); (1) heavily sclerotized, modified into flat, simple

plates (Figs. 47-49, 55-56); (2) heavily sclerotized, elaborately modified into somewhat rectangular plates with anterior rodlike and posterior digitate processes (Figs. 50-54). The weakly sclerotized A8 pleural lobes are widespread in many heliodinids as well as in all outgroups. The two modified states are found in *Aetole*, with the most complicated condition (state 2) found only in the Tripunctella/Extraneella Groups.

Character 10. Condition of tergum of A8 in male. Two states are recognized: (0) unmodified (Figs. 44-46, 50); (1) reduced to a small lobe or vestigial (Figs. 47-49, 51-56). Most heliodinids and all yponomeutoid outgroups have a broad rectangular or triangular, prominent A8 tergum in males. Reduction of the tergum is found consistently in several groups of heliodinids, and this condition is interpreted as a synapomorphy for those groups.

Character 11. Anterior margin of tergum of A8 in male. Three states are recognized: (0) no process (Figs. 44, 47-56); (1) with a pair of triangular processes extending anteriorly beneath A7 (Fig. 45); (2) with a pair of elongate rod-like processes extending anteriorly beneath A7 (Fig. 46). The ground plan state of this character in Yponomeutoidea is the absence of processes on A8 in the male because all outgroups and most heliodinids lack processes on this sclerite. The processes occur in several groups; each apomorphic state unites a pair of heliodinid members separately. Thus the two types of processes evidently have evolved independently.

Character 12. Male coremata. Two states are recognized: (0) present, forming pouches or shallow depressions containing scales (Figs. 44-46); (1) reduced to a membranous threadlike structure without scales (Figs. 47-56). Males of most Yponomeutoidea have paired coremata between pleural lobes of A8 and the genitalia, which presumably function in pheromone release. Members of *Aetole*, however, have the coremata rudimentary, a synapomorphy for its species. Interestingly, females of the Bella Group of *Aetole* have sternum A7 formed into a pair of folds that usually contain scales, suggesting a shift in the premating recognition mechanism.

Within the groundplan (state 0) there are diverse forms of coremata and correlated scaling. Although each type is fairly consistent within a specific lineage, there are unresolved problems in defining homologies, including possible transformation series and parallel development of similar forms in independent lineages. Therefore, we did not define states for the cladistic analyses. However, some of these forms may serve as useful diagnostic characters for groups above the species level in Heliodinidae.

Character 13. Length of medial spurs of metatibia. Two states are recognized: (0) inner spur at least 1.5 X longer than outer one (Fig. 158); (1) inner spur less than 1.5 X longer than outer one (Figs. 159-160). The inner medial spur of the metatibia in Yponomeutoidea usually is much longer than the outer one. However, equal or nearly equal length medial spurs are consistently found in a few groups of heliodinids, which is interpreted as an apomorphic state.

Character 14. Hind leg posture. Two states of behavior occur: (0) not raised (Fig. 153); (1) raised to about 45° above the body axis (Fig. 152). Heliodinids either perch with their hind legs in contact with the substrate, as most moths do, or hold them aloft, projecting above the plane of the abdomen. The behavior is species-consistent

by every individual. The behavior has been observed and recorded for a sufficient proportion of the North and Central American species that it provides a useful comparison in the cladistic analyses. We consider the raised hind leg posture derived because all yponomeutoid outgroups and the putative basal lineages within Heliodinidae for which the behavior is known (e.g., *Epicroesa* and *Lamprolophus*) do not raise the hind legs.

Character 15. Form of signum/signa. Four states are recognized: (0) not, or shallowly, invaginated, with tiny teeth-like, sclerotized processes on outer surface (Figs. 108-132); (1) deeply invaginated, forming a single projection, without teeth-like processes (Figs. 133-146); (2) invaginated, forming two transverse processes (Fig. 147); (3) absent (Fig. 148). The form of the signum/signa in Heliodinidae shows a high degree of variation, as it does in the other yponomeutoid families. The forms are so variable they provide limited resolution to phylogenetic relationships within Heliodinidae. The division of states in this analysis offers synapomorphies to terminal lineages but not to basal ones. It seems inappropriate to subdivide this character into numerous states for each recognized form without understanding the underlying homology of the structure.

Character 16. Position and symmetry of signum/signa. Three states are recognized: (0) present both on dorsal and ventral wall of corpus bursae, symmetrical (Fig. 132); (1) present both on dorsal and ventral wall of corpus bursae, asymmetrical (Figs. 122-128); (2) present on one side of corpus bursae only (Figs. 108-121, 130-131, 133-147) [absent = no comparison]. Because there are diverse forms of the signa in the outgroups, it is difficult to interpret the relationships among the states of this character. Parsimony analysis concluded the double signa states were derived from the single signum state, chiefly because the single signum is widespread in both heliodinids and a number of outgroups. However, double signa occur in members of certain outgroups. A better understanding of the polarity of this character may emerge when cladistic relationships among the outgroups are better resolved.

Character 17. Texture of signum/signa. Two states are recognized: (0) uniform texture (Figs. 108-112, 122-147); (1) two textures, with the proximal portion coarser than the distal portion (Figs. 113-121). State 1, illustrated by Powell (1991) in *Lithariapteryx*, is a synapomorphy for *Lithariapteryx* and *Neoheliodines*.

Although difficult to code properly at this point, the structure of the signum in *Lithariapteryx* and *Neoheliodines* is extremely similar, suggesting a synapomorphy for the two lineages. There is a comparable situation in *Epicroesa* and *Philocoristis*, with a simpler form of the signum.

Character 18. Point of origin of ductus seminalis. Two states are recognized: (0) on ductus bursae (Figs. 108-112, 122-132, 147-148); (1) on corpus bursae (Figs. 113-121, 133-146). The point of origin on the ductus bursae is widely exhibited in outgroups and in many heliodinids and is inferred as the plesiomorphic state. The derived state, however, shows extensive parallelism and is found in several distantly related ingroup taxa and in Glyphipterigidae.

Character 19. Appendix bursae. Two states are recognized: (0) absent (Figs. 108-118, 122-128, 132-146); (1) present (Figs. 119-121, 129-131, 147-148). This structure

was termed “accessory corpus” by Harrison and Passoa (1995), who used it as a diagnostic feature to separate two closely related *Neoheliodines* species. We follow Klots (1970) in calling it the appendix bursae. The absence of an appendix bursae is predominant in heliodinids and yponomeutoid outgroups and is interpreted as the groundplan for Heliodinidae. The presence of this structure, although fairly homoplasious, has value in defining groups such as the *Copocentral/Scelorthus* clade.

Character 20. Shape of medial band of ventral branches of apophyses anteriores. Two states are recognized: (0) broad, triangular or somewhat rectangular (Figs. 111-148); (1) sharply attenuate into a longitudinal bar (Figs. 108-110). Because the fusion of the posterior ends of the apophyses anteriores into a medial bridge is considered an autapomorphy of Heliodinidae, it is not possible to interpret the transformation of states based on outgroup comparison. State 1 is found in a few, mostly basal lineages, suggesting a plesiomorphic state. Conversely, the reduction might be interpreted as independently derived because so few taxa possess it.

Character 21. Base of ductus bursae. Two states are recognized: (0) membranous, unmodified or weakly sclerotized (Figs. 108-113, 122-131, 133-145, 147-148); (1) heavily sclerotized into a cylinder immediately subtending the ostium bursae (Figs. 114-121, 132, 146). Although homoplasious, occurring in several terminal taxa, the cylindrical “antrum” defines some terminal clades. For example, it is considered a synapomorphy that unites the species of *Neoheliodines*.

Character 22. Sclerotization of ductus bursae excluding the base. The two states recognized are (0) absent, entire ductus bursae membranous (109-132, 134-138, 140-148); and (1) heavy sclerotization on ductus bursae (Figs. 108, 133, 139). The sclerotization of the ductus bursae evidently had independent origins in the evolutionary history of Heliodinidae. A membranous ductus bursae is the ground plan of this family because all the yponomeutoid outgroups lack sclerotization.

Character 23. Structure of dorsal side of tegumen. The two recognized states are (0) unmodified; and (1) with a pair of prominent projections extending posteriorly (Figs. 96-104). State 1 is consistent in the four species groups of *Aetole* and absent in the other ingroups and the outgroups (Fig. 1).

Character 24. Basal end of tegumen. The two recognized states are (0) unmodified (Figs. 59-95, 105-106); and (1) produced laterally into a pair of triangular or rod-like processes (Figs. 96-104). Although they are not obviously related functionally, characters 23 and 24 are highly correlated: all taxa that possess state 1 of character 23 also have state 1 of character 24.

Character 25. Position of opening of bulbus ejaculatorius on phallobase. The two recognized states are (0) basal (anterior) end of phallobase (Figs. 59-89, 101, 104-105); and (1) recessed from base (Figs. 90-100, 102-103). The inferred derived state 1 occurs in a few groups defined by other synapomorphies, but it shows some apparent character state reversal.

Character 26. Upcurved hook at distal tip of aedeagus. Two states are recognized: (0) absent (Figs. 59-91, 96-101, 105-106); (1) present (Figs. 92-95, 102-104). The formation of a sclerotized upcurved hook on the aedeagus was not observed in the outgroup taxa; it occurs only in a few Neotropical heliodinid lineages, suggesting a

synapomorphy for them.

Character 27. External processes near or at distal end of aedeagus. The two recognized states are (0) absent (Figs. 59-73, 77, 79, 83-85, 87-97, 99-105); and (1) present (Figs. 74-76, 78, 80-82, 86, 98). Minute, multiple external processes at the distal region of the aedeagus occur in taxa in which the aedeagus is very elongate and slender. Although such processes are absent in several species of *Embola*, their presence in some species of *Embola* may indicate a synapomorphy for this genus within the *Pseudastasia/Heliogemma* clade.

Character 28. Distal end of saccus. Two states are recognized: (0) not swollen (Figs. 59-73, 89-104); (1) swollen into a spherical club (Figs. 74-88, 105-106). The swollen, spherical, club-like tip of the saccus is found exclusively in Heliodinidae, as a derived state for a few taxa.

Character 29. SV setae on A9 of late instar larva. The two recognized states are (0) two setae (Fig. 54); and (1) one seta (Fig. 55). Application of this character to phylogenetic analysis in Yponomeutoidea is problematic, in part because larvae of many taxa are unknown. Within Heliodinidae, we found a single SV seta only in *Neoheliodines hodgesi* and *N. vernius* and two setae in *Lithariapteryx*, *Embola cyanozostera* and *E. powelli*, several species of *Aetole* (Table 6), and *Scelorthus*. Harrison and Passoa (1995), however, reported a single seta in *Embola ionis*, as well as two species of *Neoheliodines*. We have seen no description or illustration of this character for *Heliodines roesella*, but we assigned state 1 because Kyrki and Itamies (1986) and Kyrki (1990) listed a single seta for Heliodinidae. We assume their statement was based on *H. roesella*, because it is the only heliodinid in Europe, and Kyrki (1984) reported having studied its larva. Larvae of *Pseudastasia*, *Philocoristis*, *Euheliodines*, and *Heliogemma* are unknown.

It is difficult to interpret the transformation of the two states among heliodinid groups. Although the two SV setae predominate in heliodinids, both states are encountered in yponomeutoid outgroups. According to Kyrki (1990), Yponomeutidae and some ypsolophid species have two SV setae (state 0), but all other yponomeutoid families have one (state 1). Based on available data, a single SV seta seems to be an autapomorphy of *Neoheliodines*. Even if the European *Heliodines roesella* is confirmed to have one seta, we will not know whether the state in that taxon is a ground plan for Heliodinidae or an autapomorphy of this long isolated taxon.

Character 30. Number of lateral bristles on A2 through A7 of pupa. Two states are recognized: (0) three (Figs. 168-170); (1) two (Figs. 171-172). The possession of lateral bristles on the pupae, suggested as an autapomorphy for heliodinids by Kyrki (1984) based on European *Heliodines roesella*, was confirmed by our study for *Embola*, *Epicroesa*, *Lamprolophus*, *Lithariapteryx*, *Neoheliodines*, *Scelorthus*, and all species groups of *Aetole* except the Calcifer Group. Therefore, transformation of the states cannot be determined by outgroup comparison.

The numbers of lateral setae are constant within each heliodinid lineage. All the basal lineages have two prespiracular and one postspiracular setae from A2 to A7 (state 0), whereas just one prespiracular seta (state 1) is found in some terminal lineages of heliodinids. State 1 is consistently correlated with several developmentally

unrelated adult characters (characters 10, 12, and 15), thus representing a synapomorphy.

Character 31. Larval feeding behavior. Four states are recognized: (0) external feeding; (1) leaf mining; (2) stem boring; (3) cecidomyiid gall boring. Although perhaps too flexible to offer phylogenetic information, larval feeding behaviors are fairly consistent within species and closely related lineages. Feeding behaviors were not included in the cladistic analysis but were mapped on the proposed phylogenetic tree after the analysis was done.

Characters 32 to 36. These are the five heliodinid synapomorphies discussed above (Table 2).

RESULTS OF PHYLOGENETIC ANALYSES

Parsimony analysis produced 48 equally parsimonious trees, each requiring 69 steps, and with an overall character consistency index (CI) of 0.609 and retention index (RI) of 0.814. After a posteriori weighting was applied to these 48 trees, a second parsimony analysis improved the result to 12 equally parsimonious trees with a CI of 0.861 and an RI of 0.951. Of the 12 trees, only 6 differed in topology within Heliodinidae.

Figure 1 shows the preferred cladogram of the six trees. A cladogram that has maximum differences from the preferred cladogram is shown in Figure 2. There are only two differences between the two trees. First, *Embola* is the sister group to the *Pseudastasia/Heliogemma* clade in the preferred cladogram. The alternative topology is rejected because character 27, the lateral distal process of phallus, would need to be independently developed in some species of the genus *Embola*. Second, there is a trichotomy for the '*Heliodines*' *princeps* lineage, the *Lithariapteryx/Neoheliodines* clade, and the clade of the rest of the terminal lineages in the preferred cladogram. The better resolved cladogram is rejected because the resolution resulted from the hind leg raising behavior, character 14, which is yet to be observed for the Australian '*Heliodines*' *princeps* Meyrick.

A strict consensus tree was computed from the 12 trees produced in the parsimony analysis (Fig. 3). This consensus tree supports the topology of the preferred cladogram (Fig. 1) except that the relationships among *Embola*, the *Pseudastasia/Heliogemma* lineage, and the *Aetole/Scelorthus/Copocentra* lineage remain unresolved.

A subset of the outgroups, including only Bedelliidae, Lyonetiidae, Plutellidae, and Ypsolophidae, was used for another run of the parsimony analysis using the same procedures of the first run. The topology of the trees did not change. Finally, all the outgroups were removed and the basal group, *Heliodines*, was assigned as the hypothetical outgroup of the remaining ingroup OTUs. Again the topology of the resulting trees did not change.

Compatibility analysis identified two largest cliques of 17 characters each. Fifteen characters occurred in both cliques (4, 6, 8, 9, 10, 11, 12, 14, 16, 17, 20, 23, 24, 27, 30). The differences in the two cliques were one had characters 19 and 28, the other

had characters 13 and 15. The cladograms produced from the two cliques are shown in Figures 4 and 5.

Of the two cladograms produced from the compatibility analysis, the one shown in Figure 4 is less preferred because the presence of an appendix bursae was regarded as a synapomorphy for the *Scelorthus/Copocentra* and *Pseudastasia/Heliogemma* clades. Yet, an appendix bursae was observed in some but not most species of *Neoheliodines*, indicating its presence is fairly homoplasious.

The cladogram shown in Fig. 5, although less resolved than those produced from the parsimony analysis, has a topology generally similar to the preferred parsimony analysis cladogram. In overall topology there is reasonable congruence between the parsimony and compatibility trees. Several convincing relationships are common to both:

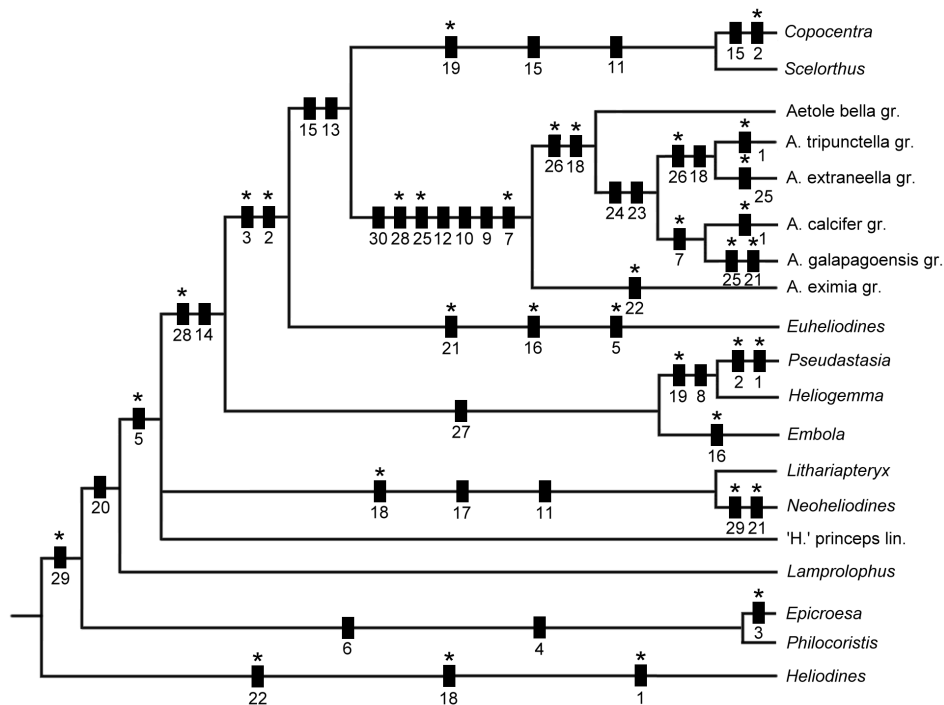

Fig. 1. Proposed phylogeny of Heliodinidae. * = homoplasious character states. Abbreviations: "H." = species described in *Heliodines*, not given formal generic assignment in this study; gr. = species group; lin. = lineage. Numbers refer to characters (listed in Table 2).

1) *Heliodines s. str.*, *Epicroesa*, and *Philocoristis* appear in the basal position in the phylogeny of Heliodinidae. *Epicroesa* and *Philocoristis* form a monophyletic group

sharing stalked forewing M1 and M2 veins and a distally drooping forewing.

2) *Lithariapteryx* and *Neoheliodines* form a clade recognized by possession of a pair of elongate anterior tergal processes on the 8th abdominal segment in males and a two-texture, lanceolate signum in females.

3) *Pseudastasia* and *Heliogemma* are sister groups united by dorsoventrally compressed antennae and lateral processes near the distal end of the phallus. Although not identified in the character compatibility analysis, *Embola* likely is the sister group to these two genera, as shown in the parsimony analysis, because most *Embola* species also possess lateral processes near the distal end of the phallus.

4) *Scelorthus*, *Copocentra*, and *Aetole* form a monophyletic group recognized by the invaginated signum (lost in *Copocentra*) and a pair of nearly equally long medial spurs of the metatibia.

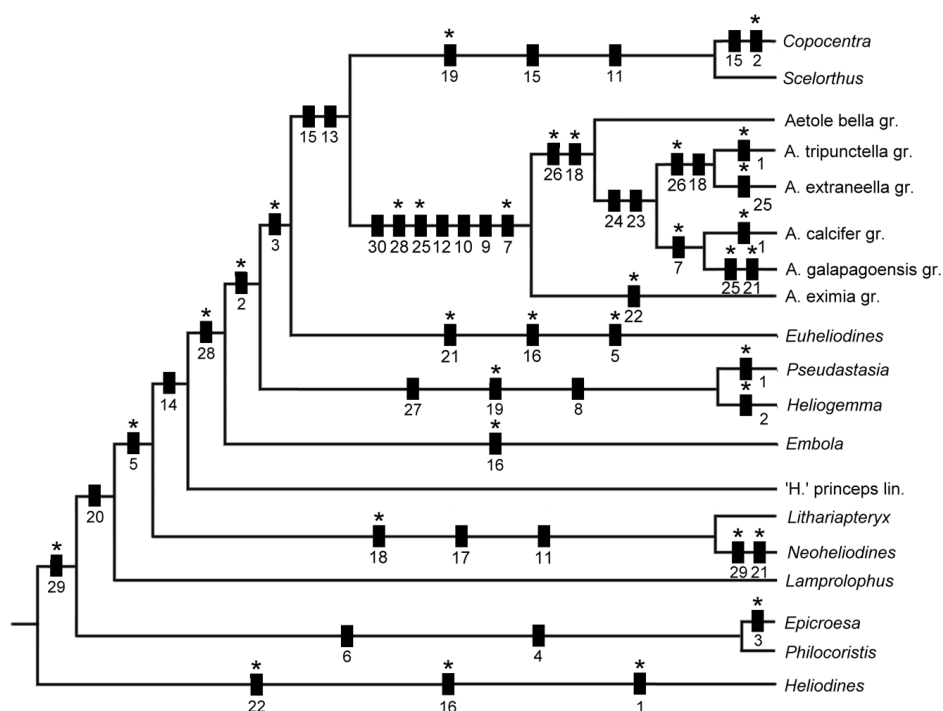

Fig. 2. A rejected cladogram of Heliodinidae. * = homoplasious character states. Abbreviations: see Fig. 1.

5) The sister relationship between *Scelorthus* and *Copocentra* is affirmed by the presence of a pair of elongate, rod-like tergal processes from the anterior margin of the 8th abdominal segment in the male (character 11), and by having the appendix bursae at the same position on the corpus bursae, a presumed homology.

6) The genus *Aetole* forms a monophyletic group, strongly supported by at least four characters: heavily sclerotized 8th abdominal pleural lobes in males; a reduction in the tergum of the 8th abdominal segment; a reduction in coremata with internal scales

missing; and one postspiracular lateral bristle present on the pupa, contrasted with two in other heliodinids. The broad, oblong rather than slender, linear scaling behind the eyes is also unique in *Aetole*, but species in the Calcifer and Galapagoensis Groups have linear scaling, the presumably plesiomorphic condition. A terminal connection of the bulbus ejaculatorius to the phallus is also unique for *Aetole* but with the possible reversal in the Extraneella and Galapagoensis Groups. *Aetole* is the best supported clade in the analysis.

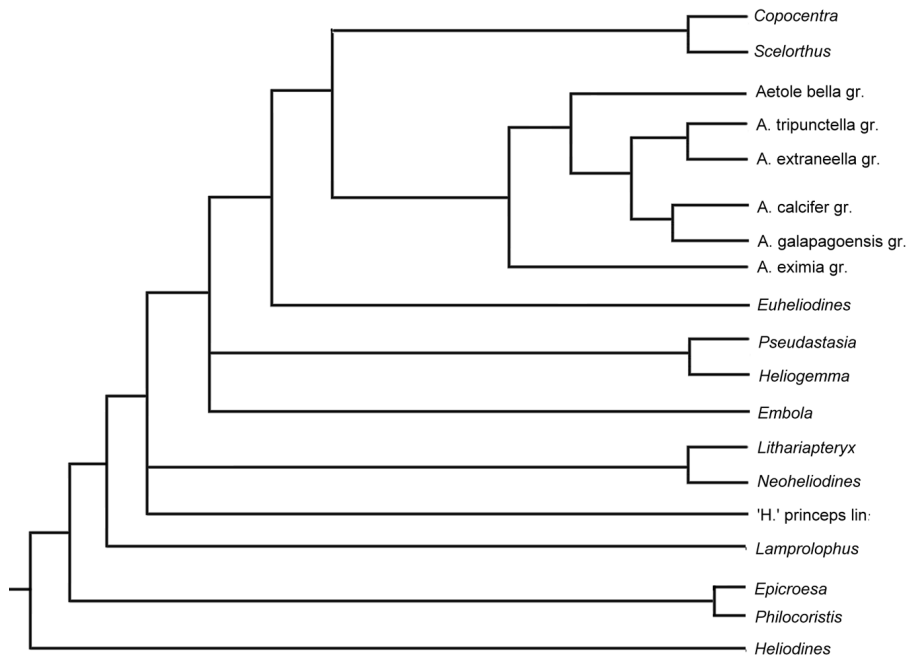

Fig. 3. Strict consensus tree produced from 12 trees from the data matrix shown in Table 3. Abbreviations: see Fig. 1.

Within *Aetole*, the Eximia and Bella Groups differ markedly in morphology and are basal to the remaining members of *Aetole*. Each of the two species groups possesses a few autapomorphies not shown on the cladogram (see species group diagnoses).

The Tripunctella, Extraneella, Calcifer, and Galapagoensis Groups represent a monophyletic group recognized by a modified tegumen, strongly produced anteriorly and elongated into lateral lobes posteriorly. The Tripunctella and Extraneella Groups are sister to each other as shown by the highly modified 8th abdominal pleural lobes in males.

The hind leg lifting behavior (character 14) unites many OTUs (Fig. 1). However, only species in *Aetole*, *Scelorthus*, *Copocentra*, and some *Embola* were observed for this behavior. The PAUP program automatically assumed *Euheliodines*, *Pseudastasia*, and *Heliogemma* possess this behavior, which needs verification.

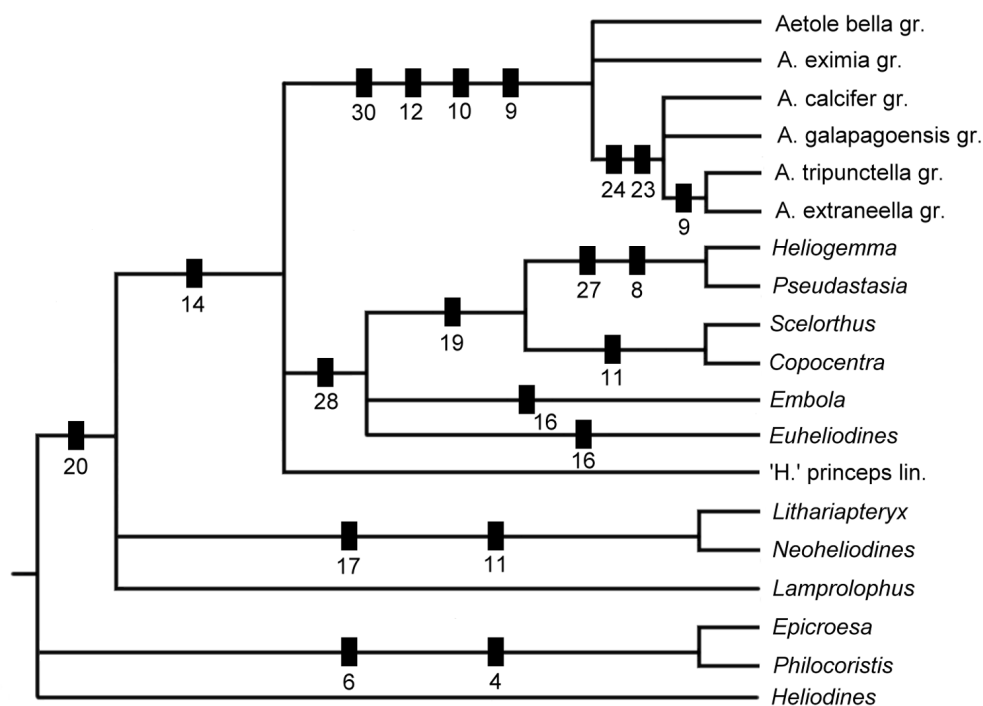

Fig. 4. Cladogram of Heliodinidae based on clique of 17 characters (4, 6, 8-12, 14, 16, 17, 19, 20, 23, 24, 27, 28, 30). Abbreviations: see Fig. 1.

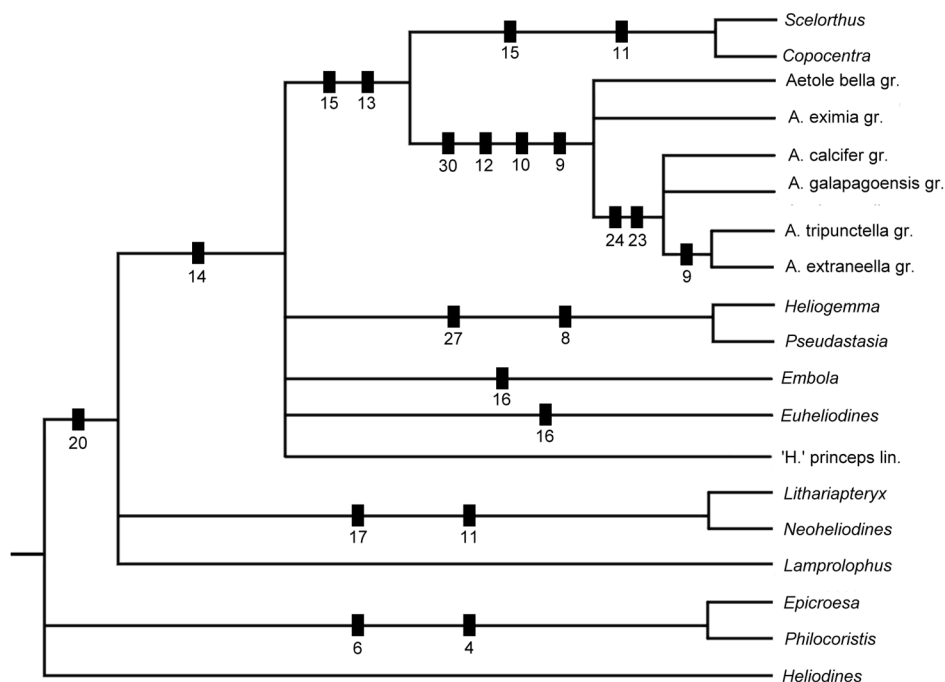

Fig. 5. Cladogram of Heliodinidae based on clique of 17 characters (4, 6, 8-17, 20, 23, 24, 27, 30). Abbreviations: see Fig. 1.

There are 25 or 26 species of heliodinids known to use Nyctaginaceae as larval hosts (Table 6), approximately 75% of those for which larval host plants are recorded, and use of Nyctaginaceae appears to be a worldwide pattern (Powell 1980, Powell et al. 1999, present data). Four other plant families, Aizoaceae, Chenopodiaceae, Phytolaccaceae, and Portulacaceae, are members of the Order Caryophyllales together with Nyctaginaceae, based on the classifications of Cronquist (1981) and Mabberley (1987). These five families combined are used by 30 species of heliodinids in 12 genera or species groups of *Aetole*, including the basal lineages (Fig. 6). Hence there is little doubt that Caryophyllales is the ground plan for heliodinid larval host associations.

Among Caryophyllales feeders that do not use Nyctaginaceae, Chenopodiaceae and Phytolaccaceae feeding are found in the most basal lineage, the European *Heliodines roesella*, suggesting that specialization to Caryophyllales feeding occurred in the early evolution of the Heliodinidae. Chenopodiaceae and Phytolaccaceae feeding may be interpreted as the most plesiomorphic condition of heliodinid host associations, with Nyctaginaceae feeding subsequently evolved and widely used during radiation of extant heliodinids. Alternatively, Nyctaginaceae feeding may be the ground plan for the Heliodinidae; Chenopodiaceae and Phytolaccaceae feeding

may be derived from Nyctaginaceae feeding during the long history of isolation of the *H. roesella* lineage.

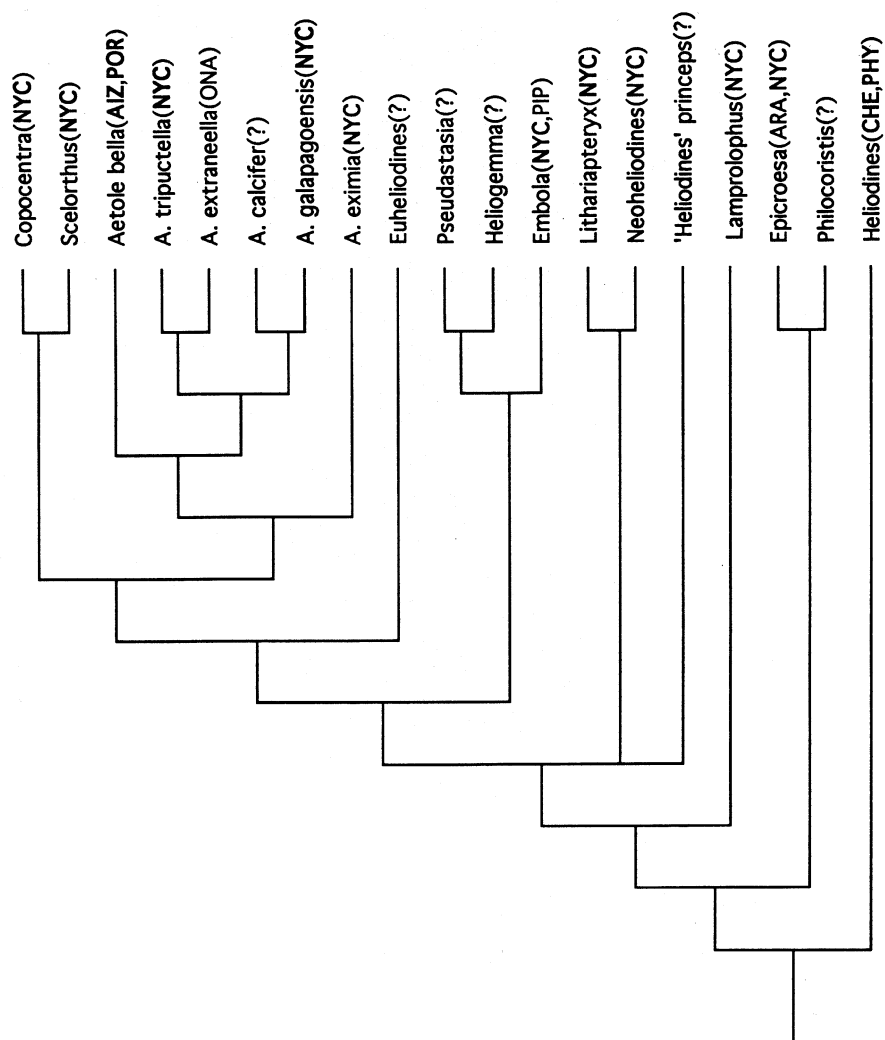

Fig. 6. The families of larval host plants used by heliodinids mapped on the proposed phylogeny of Heliodinidae (Fig. 1). Families of the Order Caryophyllales given in **boldface**. Abbreviations: **AIZ** = Aizoaceae; **ARA** = Araliaceae; **CHE** = Chenopodiaceae; **NYC** = Nyctaginaceae; **ONA** = Onagraceae; **PHY** = Phytolaccaceae; **PIP** = Piperaceae; **POR** = Potulacaceae; ? = larval host unknown.

Portulacaceae and Aizoaceae feeding are confined to the Bella Group of *Aetole*. There is no doubt these adaptations were derived from the Nyctaginaceae feeding state, since the sister lineages of the Bella Group use Nyctaginaceae as larval hosts (Fig. 6).

The remaining three plant families used by heliodinid larvae, Onagraceae (Myrtales), Araliaceae (Apiales), and Piperaceae (Piperales), are remote from Caryophyllales in plant phylogeny (Cronquist 1981; Dahlgren 1980; Thorne 1981). in South America, a record that needs confirmation. Each is known to be used by a single species of derived heliodinid, according to our cladistic analysis (Fig. 6): Onagraceae by *Aetole extraneella* in California, Araliaceae by *Epicroesa chromatorhoea* in northern Japan, and Piperaceae by *Embola obolarcha*.

SYSTEMATIC ACCOUNT

This treatment presents descriptions of North American, Caribbean, and Central American species that formerly were assigned to *Heliodines* Stainton or were undescribed members of the same clades (Table 1, Figs. 1-5). These are assigned to two genera based on older names given new status from synonymy (*Embola* Walsingham and *Aetole* Chambers) and three new genera (*Neoheliodines*, *Heliogemma*, and *Euheliodines*). Species known from one sex only are included if characters agree with species known from both sexes, enabling assignment to one of the above genera. Species from other geographic regions formerly assigned to *Heliodines* whose characters define them as independent clades are redescribed, that is, *Heliodines roesella* (L.) in Europe, '*H.*' *princeps* Meyrick in Australia, and *Aetole galapagoensis* (Heppner and B. Landry) in the Galapagos Islands. South American species that could be assigned confidently to one of the above genera are transferred as new combinations (Table 1) but are not redescribed. In addition, diagnoses and illustrations of type or representative species for each of the remaining world genera of Heliodinidae are presented. Species for which only a unique type is known, characters of which do not define a generic placement, are redescribed but not given generic assignment, namely, '*Heliodines*' *aureoflamma* Walsingham, '*H.*' *marginata* Walsingham, and '*H.*' *urichi* Busck.

Family HELIODINIDAE Heinemann

Heliodinidae Heinemann 1877: 518.

Type genus: *Heliodines* Stainton, 1854.

Diagnosis. Members of the family Heliodinidae are metallic-colored, mostly diurnal moths. They have the following combination of characters: (1) base of haustellum naked (Figs. 154-157); (2) head scales closely appressed (Figs. 154-156); (3) metallic-colored scaling covering body and wings; (4) apophyses anteriores with ventral branches originating from a medial band that forms a sclerotized bridge between them (Figs. 58, 63); (5) tegumen enormously expanded posteriorly with gnathos completely fused with it or absent (Figs. 57, 161-162); (6) pupa with stiff lateral and dorsal setae (Figs. 164-167).

Head (Figs. 154-156): Scales lanceolate, closely appressed, oriented longitudinally, usually metallic gray, black, or orange; a hood-like, appressed, scale tuft extending backward from posterior edge of vertex. Ocellus prominent. Chaetosema absent. Antenna filiform, thickened; scape only slightly wider than base of flagellum; pecten absent. A rim of bristlelike or oblong scales present in front of occipital sulcus and behind eyes. Maxillary palpus rudimentary. Haustellum well

developed, long, unscaled. Labial palpus three-segmented, short, porrect or drooping, with appressed scaling. **Thorax:** Scaling appressed; scaling of patagia thickened in some species. Tegula elongate, pointed posteriorly. **Legs:** Tibial spurs 0-2-4, inner spur of each pair longer than outer one (Figs. 158-160). Tarsomere ventrally with several apical spurs. In some groups, metatibia ventrally with bristlelike scales between medial spurs, terminally with bristlelike scales surrounding apical spurs (Figs. 159-160); tarsal segments also bearing similar apical scales. **Wings** (Figs. 26-43): Lanceolate or ovate, apex acute or obtuse. Hindwing narrower than forewing. **Forewing:** 10-12 veins. Sc extending to costa at or beyond middle. R1 and Rs connate, Rs between R1 and R2 sometimes rudimentary or absent; R3, R4, R5 disconnected from Rs. R5 extending to or near apex. Two M veins separated or stalked proximally. CuA with CuA2 present or absent. CuP vestigial. 2A vestigial and inconspicuous in most species. 1A + 2A connate proximally when 2A present. Fringe shorter than wing width. Retinaculum of females composed of a subcostal series of arched, stiff hairs in most species (Figs. 27-43), forming a flap in one species (*Helioides roesella*) (Fig. 26). **Hindwing:** 5-6 veins. Rs connate with M1 proximally in some species. M2 separated from M1. CuA with CuA2 present or absent. Fringe along dorsal margin longer than wing width. Frenulum in males with one bristle, in female with one or two bristles. **Abdomen** (Figs. 44-47, 50-51): Scales closely appressed, in some species modified scale tufts present. Terga 1 and 2 fused, transverse suture delineated by anterior margin of tergum 2 or posterior margin of tergum 1 with lateral margin sclerotized rim. Sternum 2 of tineid type, with slender apodemes and sternal rods extending posteriorly 0.67 to entire segmental length; an anterior transverse rim present. In some species tergum 8 reduced to transverse lobe or absent. Sternum undifferentiated for most species but modified extensively in some. Pleural lobes of A8 membranous or sclerotized into various forms. Paired coremata usually present between pleural lobes of A8 and male genitalic capsule, usually forming pouches containing long scales but in some species reduced into rudimentary threads. In females sternum 8 undifferentiated or expressing various modifications, in few species forming a fold containing a pair of scale clusters. **Male genitalia** (Figs. 57, 161-162): Generally symmetrical, except phallus of some species twisted or asymmetrical distally. Tegumen enormously expanded posteriorly, in many species protruding beneath and beyond socii. Vinculum fused with tegumen, inconspicuous. Saccus extremely elongate in many species, with distal end swollen in some species. Socii represented by a pair of setose processes of various forms. Gnathos absent or completely fused with tegumen. Valva simple, well developed, setose, forming laterally appressed, usually stalked, lobes of elongate, semicircular or crescent shape. Phallus enormously elongate compared to tegumen length, in some species sharply narrowed and extremely elongate distally. Cornuti absent in most species, especially those with narrow aedeagus. Ductus ejaculatorius enclosed in a membranous chamber (= bulbus ejaculatorius). Coecum penis pouchlike in most species but elongate, coiled in certain species. **Female genitalia** (Fig. 58): Apophyses anteriores slender, with ventral branches originating from a medial sclerotized band or disk of various forms. Apophyses posteriores attenuate distally, papillae anales

weakly sclerotized. Corpus bursae single, ovoid, in some species somewhat elongate, densely scobinate or foveolate over entire surface. Signum/signa usually present, form extremely variable, absent in few species. Appendix bursae present at posterior end of corpus bursae in some species. Ostium bursae present between sternum 7 and 8, in some species with sclerotization around ostium. Sinus vaginalis forming a shallow membranous area surrounding ostium bursae. Ductus bursae membranous or partially sclerotized.

Sexual dimorphism in size, color, or secondary sexual characters not obvious in most species, other than the abdominal coremata.

The homology of the socii of Heliodinidae was questioned by Kyrki (1984), and he used the term “posterolateral teguminal processes.” However, the phallus of heliodinids penetrates through a medial canal-like depression ventrally on the tegumen (Fig. 57), indicating the paired processes are at the position where socii should be. A weakly sclerotized, blind, setose pouch dorsad of the tegumen and socii was interpreted as tuba analis by Kyrki (1984). Because the pouch is setate and positioned above the socii (Figs. 57, 162). We consider it to be a homologue of the uncus.

KEY TO THE GENERA OF HELIODINIDAE AND SPECIES GROUPS OF *AETOLE*

1. Frenulum of female consisting of 2 bristles of unequal lengths; Old World and *Lamprolophus* in Nearctic 2
Frenulum of female with only 1 bristle, or 2 equal in length; Australia and New World5
2. FW ground color chrome orange; ductus bursae heavily sclerotized (Europe) *Heliodines*
FW ground color usually vermilion to deep red, olive green, or black, rarely orange; ductus bursae membranous or bearing a small sclerotized ring basally (not Europe) 3
3. FW flat, lanceolate to an acute tip; signum a small, circular patch of tiny spines. New World *Lamprolophus*
FW oblong, distal half bent ventrad, tip blunt; signum a large patch of minute, sclerotized granules; Old World 4
4. FW distally metallic orange with silver spots; tegumen not notched at caudal margin *Epicroesa*
FW ground color metallic olive green; tegumen notched, bifid caudally *Philocoristis*
5. Bulbus ejaculatoris elongate with dorsal bump; signum a broad, flat, obovate plate with minute spines externally along margins; Australia

- *'Heliodines' princeps* lineage
 Bulbus ejaculatoris without dorsal bump; signum absent or not a broad obovate
 plate; New World 6
6. Anterior margin of A8 tergum in male with a pair of short, triangulate processes;
 signum an elongate band of 2 textures 7
 Anterior margin of A8 in male without or with elongate processes; signum of
 uniform texture or absent 8
7. FW ground color chrome orange, metallic-colored spots weakly upraised
 *Neoheliodines*
 FW ground color pale gray and orange, metallic spots strongly bulging
 *Lithariapteryx*
8. Saccus elongate (greater than 2.5 X length of tegumen); ductus bursae elongate
 (ca. 1.5-5 X length of apophyses anteriores) (female of *Pseudastasia* unknown)
 9
 Saccus shorter (less than 2.5 X length of tegumen); ductus bursae short (less than
 or slightly longer than apophyses anteriores) 11
9. Antenna flattened dorsoventrally 10
 Antenna cylindrical *Embola*
10. FW veins R4 and R5 separate, Cu2 present; FW with orange or red markings
 *Heliogemma*
 FW veins R4 and R5 forked basally, Cu2 absent; FW unicolorous, without orange
 or red markings *Pseudastasia*
11. Frenulum in female consists of 2 bristles; socii joined by a narrow, transverse
 bridge *Euheliodines*
 Frenulum in female a single bristle; no bridge-like sclerite distinguishable
 between socii 12
12. Anterior margin of A8 tergum in male with a pair of elongate, rod-like processes;
 coremata well developed; signa double or absent 13
 Anterior margin of A8 tergum in male without processes; coremata rudimentary;
 signum single, an invaginated projection *Aetole* 14
13. FW vein Cu2 absent; socii prominent, digitate, nearly as long as tegumen length;
 signa double *Scelorthus*
 FW vein Cu2 present; socii much shorter than tegumen length; signa absent
 *Copocentra*
14. Metatibia with large hair tufts; FW metallic gray with chrome orange band to

- basal 0.5 and scattered chrome orange on dorsal half to apex
 Galapagoensis Group
 Metatibia lacking large hair tufts; FW variously marked with red, black, and lead-
 colored spots 15
15. Tegumen semi-membranous, with prominent sclerotized “basal processes”; bursa
 copulatrix very short, about equal to apophyses anteriores (female of *A. insolita*
 unknown) Eximia Group
 Tegumen sclerotized, without “basal processes”; bursa copulatrix usually much
 longer than apophyses anteriores 16
16. Pleura of A8 with anterior processes in male; outer side of metatibia with 3
 metallic black spots 17
 Pleura of A8 without anterior processes in male; outer side of metatibia with
 orange markings 18
17. FW veins R4 and R5 stalked basally. Tergum A8 in male forming a broad,
 membranous sheet, sternum modified into a blunt medial process; sternum of A7
 in female without a posterior notch Extraneella Group
 FW veins R4 and R5 separate. Tergum A8 in male reduced, lobe-like; sternum A7
 in female with a notch posteriorly Tripunctella Group
18. FW veins R4 and R5 stalked basally. Tegumen without anterior processes;
 sternum A7 in female modified, forming a transverse fold Bella Group
 FW veins R4 and R5 separate. Tegumen with anterior processes; sternum A7 in
 female simple Calcifer Group

Heliodines assemblage

Diagnosis: Forewing R4 and R5 stalked proximally. Retinaculum of female forming a flap. Ductus bursae heavily sclerotized except at base. Ductus seminalis opening near distal end of corpus bursae. Signum forming a heart-like, flat sclerite, with minute, external spines.

HELIODINES Stainton
 (Figs. 26, 59, 108, 173)

Heliodines Stainton, 1854: 243.

Type species: *Phalaena (Tinea) roesella* Linnaeus, 1758: 541, by monotypy.
 Gender masculine. From Greek, *helios*, the sun, and *dinos*, whirling rotation.
Heliodinides Turner, 1941: 24. missp.

Included species: Monobasic.

Head: Scales behind eyes linear. Antenna 0.8 X FW length. **Thorax:** A tuft of long, hair-like scales along lateral cervical sclerites. Inner medial spur of metatibia slightly more than 2 X longer than outer spur. Metatibia without ventral or terminal bristle-like scales around spur. Tarsi without apical bristle-like scales. **Forewing:** 11 veins; R1 and R2 forked with Rs (Fig. 26). **Hindwing:** 6 veins; Rs and M1 connate proximally. Frenulum with two bristles of different lengths. **Abdomen:** A8 of male weakly sclerotized, with somewhat triangular tergum. Sternum vestigial. Pleura largely membranous with posterior end forming weakly sclerotized, paired, semicircular lobes. Coremata in male a pair of shallow, inverted pockets, each containing elongate, flat scales. **Male genitalia** (Fig. 59): Tegumen stout, somewhat cylindrical; socii simple, lobe-like, bent along longitudinal axis. Saccus with posterior end truncate. Phallus with bulbus ejaculatorius joins phallobase subterminally. Cornuti a setose band proximally with two elongate, curved spines distally. **Female genitalia** (Fig. 108): Ventral bridge of apophyses anteriores linear, elongate longitudinally. Apophyses anteriores shorter than posteriores. Ductus seminalis opening on ductus bursae. Ductus bursae sclerotized except for posterior end. Signum an external plate. **Early stages:** Pupa with three lateral bristles from A2 to A7. Larval hosts are Chenopodiaceae; and, according to Lhomme (1948), Phytolaccaceae (both Order Caryophyllales).

Heliodines roesella (Linnaeus)
(Figs. 7, 26, 59, 108, 173)

Phalaena (Tinea) roesella Linnaeus, 1758: 541.

Heliodines roesella; Stainton, 1854: 244, 1859: 401; Morris, 1870: 205; Heinemann, 1877: 518; Snellen, 1882: 423; Meyrick, 1913: 17 (name list), 1914b: 20, 1928: 704; Lhomme, 1948: 508; Karsholt and Nielsen, 1976: 244; Emmet, 1985: 410; 1991: 69 (name list); Fal'kovich, 1990: 699.

Chrysoesthia roesella; Pierce and Metcalfe, 1935: 40.

Chrisoesthia (!) *roesella*; Hruby, 1964: 258 (catalog).

MALE. FW 4.4-5.1 mm (4.70 ± 0.25 mm, $n = 7$). **Head:** Metallic gray. Scaling behind eyes fuscous. Antenna metallic gray. Labial palpus cream-white with distal half metallic gray. **Thorax:** Metallic gray. Legs metallic fuscous with mesofemur and metafemur metallic gray. Spurs and areas adjacent to spurs cream-white; inner median spur of metatibia approximately 2.5 X longer than outer one. **Forewing:** Metallic chrome orange with metallic gray, linear outer margin; 5 costal and 2 dorsal metallic gray bar-shaped spots; size formula: $C2 \geq C3 > C1 > C4 > C5$, $D2 > D1$; C2 frequently fused with D1, forming transverse band. Prominent metallic gray dot distal to posterior end of C1, separated from C1 by single black dot. Additional single minute metallic gray dot frequently present between posterior tips of C3 and C4. Extensive black scaling unevenly along costa and dorsum; similar black along proximal edges of costal and dorsal spots. Spots of C3, C4, C5, D1, D2 frequently with white proximally around outer corners. Fringe metallic pale fuscous. **Hindwing:**

Metallic fuscous. Fringe metallic pale fuscous with basal portion white along both costa and dorsum, more extensive toward tornus. **Abdomen:** Metallic gray dorsally; metallic pale gray with distal tip cream-white ventrally. **Genitalia:** As in Fig. 59 (drawn from YFH slide 0887, Europe, MNCN; n = 3). Socii lamelliform, oblong, approximately 0.6 X tegumen length. Saccus slightly enlarged at base, with truncate distal tip, approximately 2.5 X longer than tegumen. Valva broad, strongly up-curved, ax-shaped. Phallus approximately 1.5 X length of tegumen + saccus. Aedeagal tip truncate. Bulbus ejaculatorius slightly elongate with a blunt tip, connected with phallobase anteroventrally. Cornuti forming a band of minute spines with two prominent, distal, sickle-like sclerites.

FEMALE. FW length 3.8-5.1 mm (4.78 ± 0.43 mm, n = 8). Color pattern as described for male. **Genitalia:** As in Fig. 108 (drawn from YFH slide 0888, Europe, MNCN; n = 3). Ventral bridge of apophyses anteriores forming single longitudinal bar with pointed distal tip. Signum forming a broad, flat, inverted heart-shaped sclerite, with minute spines scattered externally.

TYPE MATERIAL: Lectotype:♂: [EUROPE]: bearing label "Roesella, Roesella 899" (Linnaeus, Linnaean Society) (for clarification of confusion on nomenclature of this species, see Karsholt and Nielsen 1976).

SPECIMENS EXAMINED BELGIUM: 1♀ "Atrp." [Antwerp], 30.VII.01 (USNM); **GERMANY:** 1♀, Wolfsburg, 27.III.[18]99 (BHamfelt collection, USNM); 1♀ (+ 2 spms. no abd.), Munich, "6/68" (Hartuian, BMNH); no locality given, 2♂, S. Germany, 1/81 (Staudinger, BMNH), 1♂, 1♀ "75/76" (BMNH). **SPAIN:** 4♂, Gredos, Navarredonda, 27-28.VII.1970 (K. Sattler, M. Kirby, BMNH). **SWITZERLAND:** 2♂, Zurich, 17.VII.[18]57, 19. VII.[18]57, *Chenopodium* (Frey, BMNH), 1♂, 1♀, Zurich, 5/57, 3♂, 9♀, Zurich, no date (Frey, BMNH). **COUNTRY UNKNOWN:** [USSR]: 2♂ "Caucas"[Caucasus Mts.]; 1♀, "64" (BMNH); Cauc[asus Mts.] (MNCN). **EUROPE:** 1♂, "Peab. Acad; 83" (Zeller, UCB); 1♂, Baehlau Hamf., 4.11.03 (BHamfelt collection, USNM); 1♂, Bohuila, 5/51 (Zeller, BMNH); 1♀, '47 (Bremi, BMNH); 1♂, [indecipherable] (BHamfelt collection, USNM); [no locality given]: 1♀, 10/58 (Herrich-Schaeff., BMNH), 1♀, 30.VI.[18]41 (BMNH), 2♂, 6.III.[18]53 (BMNH); 3♂, 5♀, [no data] (MNCN).

GEOGRAPHIC RANGE: (Fig. 7) Central and southern Europe to Turkestan (Emmet 1985).

BIOLOGY: The biology of this species has been reported but not in detail, evidently based on observations made long ago (Emmet 1985, Fal'kovich 1990, Hruby 1964, Meyrick 1895, Morris 1870). The larvae are gregarious, living under loose structures of silk threads. The larval hosts are *Atriplex* and *Chenopodium* species, especially *A. patula* L. and *C. bonus-henricus* L., according to Emmet (1985), and *Spinacia oleracea* L. (Chenopodiaceae) (Hruby 1964). *Phytolacca decandra* L.

(Phytolaccaceae) is a food plant in France (Lhomme 1948). Larval feeding occurs in June; this species is univoltine.

REMARKS: Most of the available specimens were collected in the 19th century, and *H. roesella* is considered extinct in Belgium (Lhomme 1963). Emmet (1985) pointed out that it has not been recorded in England since about 1820, but Bland (1992) reported one specimen, presumably taken between 1952 to 1962, from northern Lincolnshire.

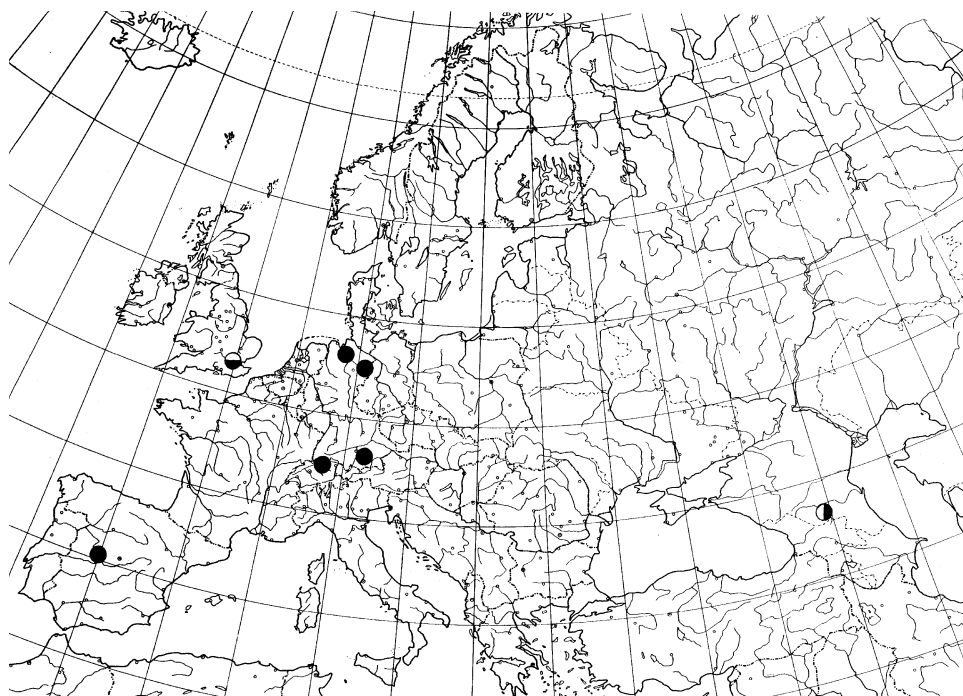

Fig. 7. Map of western Palearctic showing distribution records for *Heliodines roesella* (L.); top-open circle = extinct population; side-open circle = regional record (Emmet 1985).

Epicroesa assemblage

Diagnosis: Distal half of FW bent ventrad. Signa consisting of a patch of minute, sclerotized granules on sculptured wall of ductus bursae.

EPICROESA Meyrick
(Figs. 27, 60, 109)

Epicroesa Meyrick, 1907: 94.

Diagnosis: FW ground color metallic dark brown, tinged with deep purple and variously mottled with metallic green, pink, silver, or orange, sometimes concentrated to form bands or markings, often metallic orange with silver spots distally. Socii conical. Scales of coremata slender. Cornuti consisting of numerous spines, larger cephalad, finer caudad.

Type species: *Epicroesa ambrosia* Meyrick; by original designation. Gender feminine.

Genitalia of *E. metallifera* Meyrick (Australia): male, Fig. 60 (drawn from YFH slide 0950, Queensland, ANIC; n = 1); female, Fig. 109 (drawn from YFH slide 0952, Queensland, ANIC; n = 2).

Literature references: Diakonoff and Arita 1979: 96; Floater 1995: 31; Meyrick 1909: 94, 1914: 17; Nielsen and Common 1991: 857.

Included species: Six (Table 1). Australia, Palaearctic (Japan), Oriental (Taiwan), and Afrotropical (Seychelles Islands).

PHILOCORISTIS Meyrick
(Figs. 28, 61, 110)

Philocoristis Meyrick, 1927:102.

Diagnosis: FW ground color metallic olive green. Socii rod-like. Scales of coremata broad, enlarged distally. Cornuti less numerous than in *Epicroesa* and more uniform in size.

Type species: *Philocoristis catachalca* Meyrick, 1927; by monotypy. Gender feminine.

Genitalia of *P. catachalca* (Samoa): male, Fig. 61 (drawn from YFH slide 0928, Samoa, BPBM; n = 1); female, Fig. 110 (drawn from YFH slide 0943, Samoa, BPBM; n = 2).

Literature references: Meyrick 1927: 102.

Included species: Monobasic (Table 1). Samoa.

Lamprolophus assemblage

Diagnosis: FW ground color metallic dark brown mottled with yellow or orange bands and silver scale tufts on costa and dorsal margin. Ductus bursae enlarged at proximal end, with a sclerotized cylinder near base. Signum a circular patch with minute spines.

LAMPROLOPHUS Busck
(Figs. 29, 62, 111, 164, 174)

Lamprolophus Busck, 1900: 241.

Type species: *Lamprolophus lithella* Busck, 1900; by monotypy Gender masculine.

Genitalia of *L. lithella* (Florida): male (Fig. 62, drawn from EME slide 3777; n = 5); female (Fig. 111, drawn from EME slide 3780; n = 3).

Literature reference: Busck 1900: 241 (Florida).

Included species: monobasic.

Meyrick (1914) synonymized *Embola* with *Lamprolophus*, but the proposed phylogeny of Heliodinidae (Fig. 1) does not support this viewpoint. Hsu (2002) resurrected *Embola* as a genus distinct from *Lamprolophus* based upon a few genitalia characters.

Aetole assemblage

Diagnosis: Female frenulum single (but reversal in *Euheliodines*).

‘Heliodines’ princeps subassemblage

Diagnosis: FW metallic orange with distal 1/3 dark brown; metallic silver spots each delimited by brown scaling. Bulbus ejaculatorius of phallus enormously enlarged, elongate. Signum forming large ovate plate with minute teeth along lateral margins.

‘Heliodines’ princeps lineage
(Figs. 63, 112, 175)

Included species: ‘*H.*’ *princeps* Meyrick, 1906.

Head: Scales behind eyes linear. **Thorax:** Inner medial spur of metatibia more than 2 X longer than outer. Metatibia without ventral or terminal bristle-like scales around spur. Tarsi without apical bristle-like scales. **Forewing:** 11 veins; all separated except Cu veins. Retinaculum of female a series of arched hairs (Nielsen and

Common 1991: 858). Several costal and dorsal metallic silver- or lead-colored spots. **Hindwing:** 6 veins; all separate except Cu veins. Frenulum of female a single bristle (Nielsen and Common 1991: 858). **Abdomen:** A8 of male weakly sclerotized with broad tergum. Pleura weakly sclerotized, forming paired, semicircular lobes. Coremata forming shallow, inverted pockets containing elongate, flat scales. **Male genitalia** (Fig. 63): Tegumen stout, conical. Socii elongate, laterally flattened. Saccus elongate with truncate distal end. Valva broad, flattened. Bulbus ejaculatorius enormous, joining phallobase subterminally. **Female genitalia** (Fig. 112): Ventral bridge of apophyses anteriores transverse. Apophyses posteriores strongly curved distally. Ductus seminalis opening on ductus bursae. Signum an obovate, external plate.

'Heliodines' princeps Meyrick
(Figs. 63, 112, 175)

Heliodines princeps Meyrick 1906: 54, 1913: 18 (name list), 1914b: 20; Common 1990: 212; Nielsen and Common 1991: 857.
Heliodinides (missp.) *princeps*; Turner 1941: 24.

MALE. FW length 4.8-5.5 mm (5.3 ± 0.40 mm, $n = 3$). **Head:** Frons and vertex metallic dark gray. Hood-like scale band posterior to vertex metallic black. Labial palpus pearly white with distal tips slightly gray. Antenna metallic dark gray tinged with purple, with prominent white tip. **Thorax:** Metallic gray. Coxae with distal portions black, followed by orange distal tips. Metallic chrome orange on distal end of profemur, protibia, medial and distal part of mesotibia, and areas adjacent to spurs of metatibia. Tarsomeres 3-5 of hind legs pearly white. **Forewing:** Metallic chrome orange with distal 1/3 and basal area covered by metallic black; 5 costal and 3 dorsal metallic gray spots; size formula: $C1 > C3 > C5$, $C2 > C4$; $D1 > D3 > D2$. C4 and D2 remote from wing margins. In some specimens C2 reduced to small dot and remote from wing margin. Additional small, metallic gray dot between C5 and D3. Three longitudinal metallic gray bands; one proximal, connected to C1; two distal, parallel to each other with one shorter, on costa, the other longer, from apex. Spots unevenly edged by black. Fringe uniformly metallic gray. **Hindwing:** Uniformly metallic dark gray. Fringe metallic gray, paler near tornus. **Abdomen:** Metallic dark gray banded with orange. **Genitalia:** As in Fig. 63 (drawn from photo of slide 27928, Queensland, BMNH; $n = 1$): Tegumen stout, attenuate into acute distal end posteriorly. Socii elongate, forming laterally flattened plates, approximately 0.5 X tegumen length. Saccus elongate, approximately 1.8 X tegumen length. Valva somewhat triangular. Aedeagus up-curved near distal end, approximately 1.8 X longer than tegumen + saccus; heavily sclerotized, with numerous transversely arranged external minute teeth.

FEMALE. FW length 5.2-5.5 mm (5.37 ± 0.40 mm, $n = 3$). Color pattern as described for male but abdomen covered by extensive orange dorsally. **Genitalia:** As

in Fig. 112 (photo of slide 27929, Queensland, BMNH). Medial band of apophyses anteriores belt-like. Ductus bursae with funnel-like sclerotized antrum leading to nipple-shaped sclerite. Signum forming a broad, flat, obovate, sclerite, with minute spines scattered externally along two lateral margins.

TYPE MATERIAL: Holotype: ♂: **AUSTRALIA: QUEENSLAND:** [Brisbane], "TPL, 196" [no further data] (Meyrick collection, BMNH).

ADDITIONAL SPECIMENS EXAMINED: AUSTRALIA: QUEENSLAND: 2♂, 2♀, Cedar Bay, 1894 (M. Rothschild, BMNH); 1♀, Kuranda, 17.X.1904 (Dodd, BMNH).

Lithariapteryx subassemblage

Diagnosis: Anterior margin of A8 tergum forming a pair of invaginated, triangular, sclerotized processes in male. Signum forming longitudinal, lanceolate, sclerotized band, of two textures; anterior area much finer than posterior area. Ductus seminalis originating at proximal end of corpus bursae.

LITHARIAPTERYX Chambers (Figs. 30, 64, 113, 176)

Lithariapteryx Chambers, 1876: 217.

Type species: *Lithariapteryx abroniaeella* Chambers, 1876; by monotypy.
Gender masculine.

Diagnosis: FW ground color pale gray, metallic-colored spots more strongly raised than in other genera; veins R4, R5 separate, R stem partially to completely persistent in cell. HW with R + M stem persistent through cell. Socii reduced; saccus extremely elongate (1.7-3.4 X tegumen length). Phallus greatly elongated (1.1 X length of tegumen + saccus). Genitalia of *L. abroniaeella*: male, Fig. 64 (drawn from EME slide 3771, Calif.; n = 8); female, Fig. 113 (drawn from EME slide 3773, Calif.; n = 5). All Nearctic species figured by Powell (1991).

Literature References: Chambers 1876: 217, 1878a:117, 1878b:152; Comstock 1940: 175; Powell 1991: 92; Hsu and Powell 1997. (North and South America).

Included species: Five, four southwestern Nearctic, one Bolivia (Table 1).

NEOHELIODINES Hsu, new genus (Figs. 8-11, 31, 45 65-73, 114-121, 151, 153-154, 157, 163, 177-185)

Type species: *Heliodines nyctaginella* Gibson, 1914. Gender masculine. From Latin, *neo* = new, plus *Heliodines*.

Diagnosis: Anterior margin of A8 tergum in male with a pair of triangular processes. Ostium bursae surrounded by a sclerotized ring. A9 of late instar larva with one SV seta.

Included species: *N. albidensis* Hsu, new species; *N. arizonense* Hsu, new species; *N. cliffordi* (Harrison and Passoa 1995), new combination; *N. eurypterus* Hsu, new species; *N. hodgesi* Hsu, new species; *N. megostiella* Hsu, new species; *N. melanobasilarus* Hsu, new species; *N. nyctaginella* (Gibson 1914), new combination; *N. vernius* Hsu, new species.

Head: Scales behind eyes linear, long. Antennae approximately 0.67 FW length. **Thorax:** A row of bristle-like scales along lateral cervical sclerites. Inner medial spur of metatibia 1.5-2.0 X longer than outer. Metatibia without ventral and terminal bristle-like scales around spurs. Tarsi without apical bristle-like scales. **Forewing:** (Fig. 31) 11 veins; R1 + R2 forked with Rs; other R veins all separate. Retinaculum of female a series of arched hairs. Ground color metallic orange, distal margin with a metallic gray, black, or silver. Several costal and dorsal metallic gray or silver spots. **Hindwing:** 6 veins; all separate except Cu veins. Frenulum of female a single bristle. **Abdomen:** (Fig. 45) A8 of male weakly sclerotized with an elongate sclerotized tergum. Pleura and sternum largely membranous with posterior end of pleura forming weakly sclerotized, paired, semicircular lobes. Coremata in male forming a pair of shallow, inverted pockets each containing elongate, flat scales. **Male genitalia** (Figs. 65-73): Tegumen stout. Socii simple, stout, densely setose, laterally flattened, close to each other at base. Saccus slender, more than 2 X longer than tegumen, posterior end forming blunt tip. Valva simple, elongate, up-curved. Aedeagus with blunt distal end and apical minute teeth. Bulbus ejaculatorius joining phallobase subterminally. **Female genitalia** (Figs. 114-121): Medial, ventral band of apophyses anteriores broad, triangular or square; apophyses anteriores shorter than posteriores. Ductus seminalis opening near base of corpus bursae. Ostium bursae surrounded by a sclerotized ring. Signum elongate, lanceolate, consisting of two textures; distal portion more finely granular than proximal part. **Early stages:** Larvae with one SV seta at A9. Pupae with three lateral bristles from A2 to A7.

Forbes (1923) characterized the genus *Heliodines* as possessing forked R4 + R5 and included '*Heliodines*' *bella* and '*H.*' *nyctaginella*. Evidently he did not examine the venation of '*H.*' *nyctaginella*, and his generalization was based on '*H.*' *bella*.

The adults do not raise the hind legs in repose, observed in five of the nine described species. The larvae are external feeders on Nyctaginaceae (Order Caryophyllales).

KEY TO SPECIES OF *Neoheliodines*

1. FW with a white subapical spot (C5) *albidentus*
FW spots lead colored, none white 2
2. Metallic gray distal border of FW with an indented notch 3
Border of metallic gray distal end of FW without an indented notch 4
3. Distal end of tegumen concave; sclerotized ring of ductus bursae cup-like ...
..... *arizonense*
Distal end of tegumen protruded into a cone; sclerotized ring of ductus bursae
reduced to a small circle *cliffordi*
4. Distal end of phallus divided into two lobes 5
Distal end of phallus simple 8
5. Basal half of FW with extensive black scaling; distal lobes of phallus blunt 6
Basal half of FW with black scaling restricted to costal and dorsal margins; distal
lobes of phallus attenuate 7
6. Distal lobes of phallus asymmetrical; medial sclerotized band of apophyses
anteriores with attenuate posterior end *eurypterus*
Distal lobes of phallus symmetrical; ventral band of apophyses anteriores blunt
posteriorly *melanobasilarus*
7. Valva broadened gradually in distal half; scaling behind eyes buff
colored *megostiellus*
Valva narrowed in distal half; scaling behind eyes white *hodgesi*
8. FW with 5 costal spots of metallic gray; socii longer than tegumen; sclerotized
ring around ostium bursae bell-shaped *vernius*
FW with 6 costal spots of metallic gray; socii longer than tegumen; sclerotized
ring around ostium bursae cylindrical, tube-like. *nyctaginella*

Neoheliodines nyctaginella (Gibson), new combination
(Figs. 8, 31, 45, 65, 114, 151, 177)

Heliodines nyctaginella Gibson, 1914: 423; Forbes, 1923: 358; Clarke, 1952: 139;
Wester, 1956: 43; Heppner and Duckworth, 1983: 28 (checklist); Harrison and
Passoa, 1995: 68.

MALE. FW length 3.8-4.8 mm (4.39 ± 0.32 mm, n = 30). **Head:** Metallic gray
or pale gray with hood-like scale band posterior to vertex frequently buff-yellow.

Scaling behind eyes buff-yellow. Antenna metallic black tinged with orange, with prominent white tip. Labial palpus buff-yellow with black distal tip. **Thorax:** Metallic pale gray. Legs metallic gray with pair of dark metallic gray bands on metatibia. Medial spurs of metatibia with inner one 1.8 X longer than outer. **Forewing:** Metallic orange with metallic black outer margin; 6 costal and 3 dorsal metallic gray spots; size formula: C3 > C2, C4, C5 > C6 > C1; D3 > D1 > D2. Additional narrow metallic gray band in outer margin along termen. Spots bar-like except C6, forming acute tooth pointing inward, unevenly edged by black. Basal area with black along costa to C2 and dorsum to D1 spot. Fringe uniformly metallic gray. **Hindwing:** Uniformly metallic black tinged with orange. Fringe uniformly metallic gray. **Abdomen:** Metallic black. **Genitalia:** As in Fig. 65 (drawn from EME slide 3593, Illinois; n = 2). Tegumen narrowed distally to acute distal tip. Socii digitate with blunt distal end, approximately 1.4 X tegumen length. Saccus 4.2 X tegumen length. Valva broad, elongate, up-curved, somewhat triangular with blunt distal end. Aedeagus with two longitudinal rows of minute ventral teeth at distal end, approximately 1.1 X longer than tegumen + saccus. Cornuti forming band of scattered spines.

FEMALE. FW length 3.8-4.9 mm (4.34 ± 0.31 mm, n = 30). Color pattern as described for male. **Genitalia:** As in Fig. 114 (drawn from EME slide 3594, Illinois; n = 3). Medial band of apophyses anteriores broad with truncate posterior end. Sclerotized ring around ostium bursae wide, cylindrical. Signum with distal finer portion as long as proximal portion. Appendix bursae absent.

TYPE MATERIAL: Holotype: ♂: **CANADA: MANITOBA:** Aweme, bred from *Oxybaphus nyctagineus* [= *Mirabilis nyctaginea*], 9.VII.1913 (N. Criddle, CNC Type No. 1126). **PARATYPES EXAMINED:** **CANADA: MANITOBA:** 3 ♂, 1 ♀, Aweme, 9.VII.1913 (N. Criddle, USNM, CNC).

ADDITIONAL SPECIMENS EXAMINED: **CANADA: MANITOBA:** 1 ♀, same data as holotype. U.S.A.: **ILLINOIS: CHAMPAIGN Co.:** 2 ♂, 3 ♀, Urbana, 24.V.1942, on wild Four O'Clock *Allionia nyctaginea* [= *Mirabilis nyctaginea*] (M. V. Balduf, USNM), 2 ♂, 2 ♀, T19N, R9E, NE1/4, Sec 4, 13.VII.1993, reared from *Mirabilis nyctaginea*, emgd. 25.VII.1993 (T. Harrison, UCB). **COLES Co.:** 3 ♂, 2 ♀, T14N, R9E, NW1/4, Sec 23, 14.VI.1993, reared from *M. nyctaginea*, emgd. 16/24.VI.1993 (T. Harrison, UCB). **MACON Co.:** 1 ♀ (+ 1 ex abdomen missing), Decatur, 31.VII/2.VIII. 1920, reared from *O. nyctagineus* [= *Mirabilis nyctaginea*]. **PUTNAM Co.:** 1 ♀, 9.VIII.1955, reared from "Four O'Clock" (M. O. Glenn, FSCA). **IOWA: DICKINSON Co.:** 1 ♂, 1 ♀, Cayler Prairie, reared from *M. nyctaginea*, emgd. 12.VII.1977 (USNM). **STORY Co.:** 9 ♂, 3 ♀ + 1 ex (abdomen missing), Ames, 7/9.VIII.1918, 6 ♂, 4 ♀ (+ 1 ex abdomen missing), 2/9.VIII.1918, reared from *O. nyctagineus* (all A. W. Lindsey, USNM, CNC, UCB); 1 ♂, same locality, 2.VIII.1927, on *Rudbeckia hirta* (G. H., USNM). **WOODBURY Co.:** 1 ♀, Sioux City, 6.VII.1928 (C. N. Ainslie, USNM). **KANSAS: LABETTE Co.:** 1 ♀, Oswego, 3.IX.1965 (G. F. Hevel, USNM). **MINNESOTA:** 1 ♂, **OLMSTED Co.** (C. N. Ainslie, USNM);

SWIFT Co.: 1 ♀, Murdock, 19.VI.1964 (J. R. Powers, UCB). **OHIO: HAMILTON Co.:** 11 ♂, 2 ♀, Cincinnati, 19/21.VI.1927 (A. F. Braun, USNM, CAS, DEI). **WISCONSIN: DANE Co.:** 1 ♂, 4 ♀, Madison, 4/11.VIII.1916 (G. A. Chandler, USNM); 1 ♀ (+ 1 ex abdomen missing), ovipositing on *M. nyctaginea*, 7.VII.1965 (DNC, USNM).

GEOGRAPHIC RANGE: (Fig. 8) Canada (Manitoba); U.S.A. (Illinois, Iowa, Kansas, Minnesota, Ohio, Wisconsin).

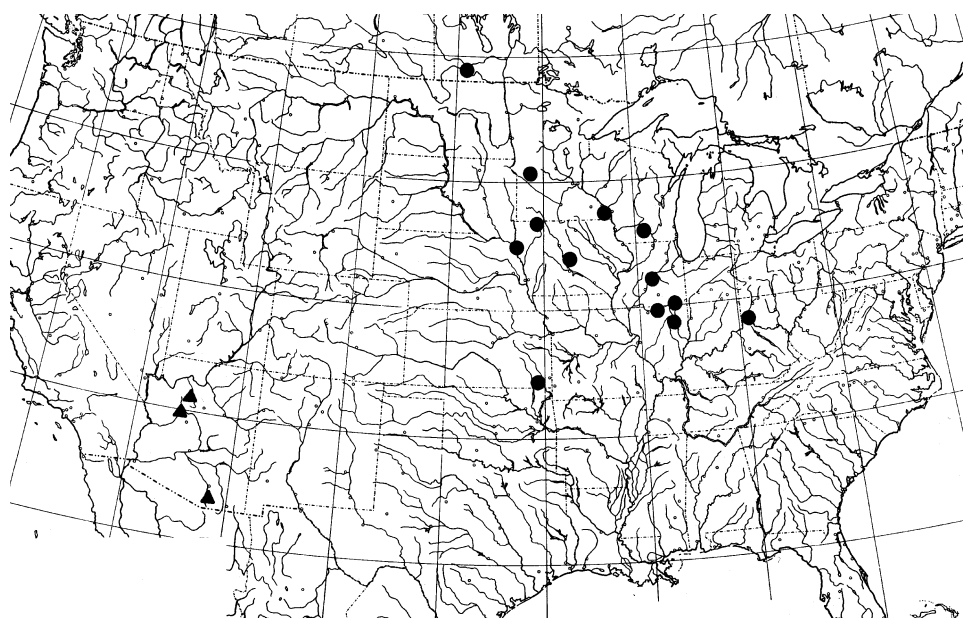

Fig. 8. Map of the United States showing distribution records for *Neohelioidines nyctaginella* (Gibson) [circles] and *N. eurypterus* Hsu [triangles].

BIOLOGY: The larval biology of the species has been reported in detail by Wester (1956) and recently by Harrison and Passoa (1995) and is summarized as follows. The host plant is *Mirabilis nyctaginea* (Michx.) in Illinois. The larva is an upper side leaf skeletonizer that sometimes feeds on flower buds. The first instar feeds without a web on the upper side or under side of leaves, depending on where eggs were laid. Later instars construct a web under which they feed. Pupation occurs on the ground, and overwintering occurs in the pupal stage. The adult does not raise its hind legs in repose (Harrison and Passoa 1995). This species is estimated to have five generations per year (Wester 1956).

Neoheliodines eurypterus Hsu, new species
(Figs. 8, 66, 115, 178)

MALE. FW length 3.8 mm (n = 1). **Head:** Metallic gray with hood-like scale band posterior to vertex cream-white. Scaling behind eyes white. Antenna metallic gray with white tip. Labial palpus white with metallic gray tip. **Thorax:** Metallic gray tinged with bluish green. Legs metallic gray with two metallic black patches on metatibia. Medial spurs of metatibia with inner one 1.88 X longer than outer. **Forewing:** Metallic chrome orange with nearly linear metallic outer margin; 5 costal and 3 dorsal metallic gray spots; size formula: C3 > C2 > C4 > C5 > C1; D3 > D1 > D2. Metallic reddish black along outer margin and spots, extensively around basal half of wing. Fringe uniformly metallic gray. **Hindwing:** Uniformly metallic black tinged with orange. Fringe uniformly metallic gray. **Abdomen:** Metallic black banded with metallic gray, distal end white. **Genitalia:** As in Fig. 66 (drawn from holotype; n = 1). Tegumen narrowed distally into elongate cone with blunt end. Socii digitate with acute distal end, approximately 1.2 X tegumen length. Saccus 3.6 X tegumen length. Valva elongate, curved upward, distal half narrowed to acute tip. Aedeagus asymmetrical, with a flat lobe and a digitate process at distal end; 5 minute, lateral teeth on flat lobe and another 5 dorsal teeth on digitate process. Phallus approximately 1.3 X longer than tegumen + saccus.

FEMALE: FW length 3.3-4.0 mm (n = 2). Color pattern as described for male. **Genitalia:** As in Fig. 115 (drawn from EME slide 3596, Arizona; n = 2). Medial band of apophyses anteriores with acute posterior end. Sclerotized ring around ostium bursae cylindrical, tube-like, its length 0.7 X width. Signum with distal finer portion 1.6 X length of proximal portion. Appendix bursae absent.

TYPE MATERIAL: Holotype: ♂: U.S.A.: ARIZONA: COCONINO Co.: Williams, 26.VI.1964 (R. P. Allen, UCB).

2 ♀ paratypes: U.S.A.: ARIZONA: SANTA CRUZ Co.: 1 ♀, Santa Rita Mtns., Madera Cyn., 4880', 1.VII.1959 (R. W. Hodges, USNM). YAVAPAI Co.: 1 ♀, Prescott, 26.VII.1991 (M. Prentice, UCB).

GEOGRAPHIC RANGE: U. S. A. (Arizona).

ETYMOLOGY: An adjective of Greek origin, *eury*s = broad plus *pteryx* = wing.

Neoheliodines hodgesi Hsu, new species
(Figs. 9, 67, 116, 179)

MALE. FW length 3.6-4.1 mm (3.78 ± 0.19 mm, n = 30). **Head:** Metallic gray with hood-like scale band posterior to vertex variable from metallic black to

buff-gray. Scaling behind eyes cream-white. Antenna metallic gray with white apical tip. Labial palpus cream-white with distal tip slightly metallic gray. **Thorax:** Metallic dark gray. Legs metallic gray with inner surfaces cream-white. Pair of metallic black patches on metatibia. Areas adjacent to spurs buff. Inner medial spur of metatibia 2.25 X longer than outer. **Forewing:** Metallic spectrum orange slightly tinged with purple, yellowish proximally, with curved metallic gray outer margin; 5 costal and 3 dorsal metallic gray spots; size formula: $C3 > C2 > C4 > C5 > C1$; $D3 > D1 > D2$. Spots, outer margin variably edged by black. Basal area with black along costa up to C4 and along dorsum up to D1. Proximal end of outer margin connected to D3. Fringe uniformly metallic gray. **Hindwing:** Metallic black, paler toward tornus. **Abdomen:** Metallic black, banded with metallic gray, frequently whitish ventrally and toward distal end. **Genitalia:** As in Fig. 67 (drawn from YFH slide 0833, Arizona, USNM and YFH 0894, Arizona, USNM, aedeagus; $n = 7$). Tegumen short; distal end protruded into a bump. Socii digitate with blunt distal end, approximately 1.5 X tegumen length. Saccus approximately 4.0 X tegumen length. Valva broad, triangular with both proximal and distal ends narrowed. Phallus approximately 2.0 X longer than tegumen + saccus, curved down around mid-point and curved upward distally with 2 prominent teeth, one hooked downward, one pointing parallel with body axis.

FEMALE. FW length 3.1-3.5 mm (3.30 ± 0.18 mm, $n = 4$). Color pattern as described for male. **Genitalia:** As in Fig. 116 (drawn from YFH slide 1018, Texas, TAMU; $n = 2$). Medial band of apophyses anteriores with obtuse posterior end. Sclerotized ring around ostium bursae well developed, short but extremely wide, length 0.4 X width, cylindrical but concave posteriorly, combined with posterior part of ductus bursae forming a funnel-like structure. Signum with distal finer portion 2.2 X proximal portion. Appendix bursae present.

TYPE MATERIAL: Holotype:♂: **U.S.A.: ARIZONA: COCHISE Co.:** Huachuca Mts., Ash Cyn., 5100', black light, 8.VIII.1991 (Y.-F. Hsu, UCB).

48♂, 4♀ paratypes: **MEXICO: BAJA CALIFORNIA SUR:** 1♀, 1 mi E Todos Santos, 13.VIII.1966, sweeping alfalfa (J. Powell, UCB); 2♂, 2 km SE El Triunfo, 1200', 9.XI.1993, reared from *Boerhavia coccinea*, emgd. 29.IX/21.X.1994, JAP 93L13 (Y.-F. Hsu, UCB). **PUEBLA:** 1♂, 2 mi SW Tehuacan, 5300', 4.X.1975, at light (Powell, T. Eichlin, T. Friedlander, UCB). **U.S.A.: ARIZONA: COCHISE Co.:** 1♀, Chiricahua Mts., nr. Portal, in desert, 21.VII.1965, on Apache plume (R. H. Arnett, FSCA); 1♂, Huachuca Mts., Carr Cyn., 30.VII.1986 (D. L. Wagner, UCONN). **PIMA Co.:** 1♂, Molino Basin, 2.VIII.1970 (Powell & P. A. Rude, UCB). **SANTA CRUZ Co.:** Santa Rita Mts., Madera Cyn., 2♂, 21-24.VIII.1946 (J. A. Comstock, L. M. Martin, LACM); same locality, 4880', 36♂, 2♀, 21.VIII to 11.IX.1959 (R. W. Hodges, USNM). **TEXAS: BEXAR Co.:** 1♂, 1♀, San Antonio, NE Reserve, 26.VI.1972 (Powell, UCB). **TARRANT Co.:** 2♂, Ft. Worth, 4.VII.1998, reared from *Boerhavia coccinea*, emgd. 20.VII.1998, JAP 98G2 (D. & J. Powell, UCB). **TRAVIS Co.:** 1♂, 1♀, Austin, Brackenridge Field Sta. (UT), 1.X.1976 (T. P. Friedlander, UT).

VICTORIA Co.: 1♂, Victoria, 16.VII.1912 (J. D. Mitchell, USNM).

GEOGRAPHIC RANGE: (Fig. 9) U.S.A.(Arizona, Texas); Mexico (Baja California Sur, Puebla).

BIOLOGY: The host plant is *Boerhavia coccinea* Mill. in Baja California Sur and Texas. The larva lives under a flat web and skeletonizes the upper side of leaves. Pupation probably occurs in debris near the host. Larvae collected in November 1993 pupated within a month but did not emerge until September and October 1994 (JAP 93L13). Several apparently viable pupae remained through the 1995 season, indicating the potential for successful prolonged diapause, but the pupae later desiccated. The long diapause as pupae suggests this species may be univoltine in desert areas with a late summer/fall flight, following onset of summer rains. In Texas, adults have been collected in June-July and October. Larvae taken at Ft. Worth in early July produced adults by late July (JAP 98G2). The records suggest two generations.

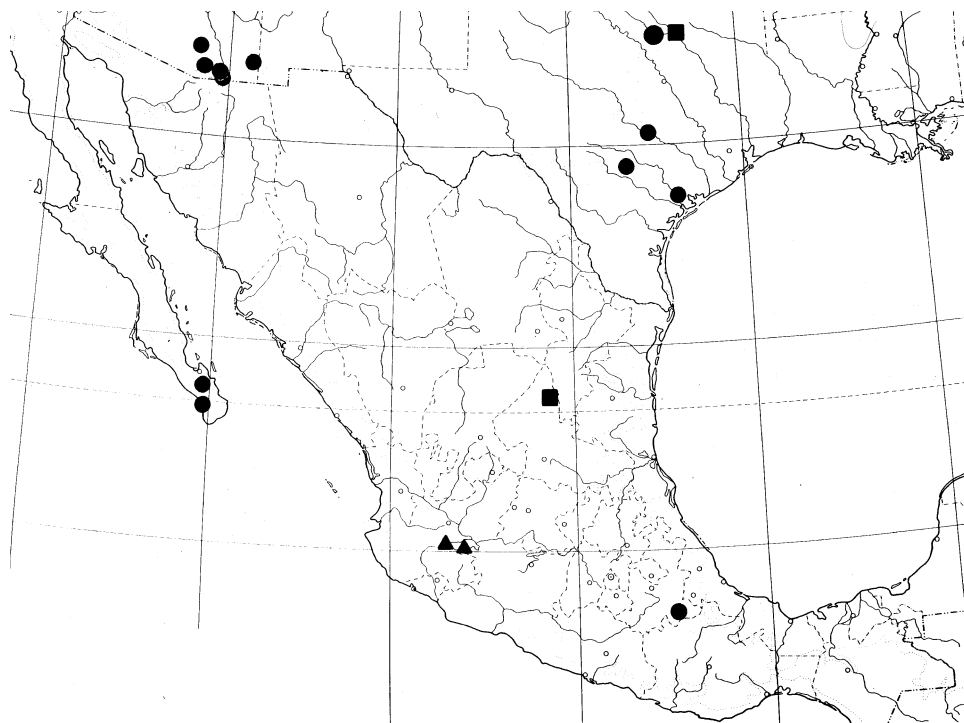

Fig. 9. Map of southwestern United States and Mexico showing distribution records for *Neoheliodines hodgesi* Hsu [circles], *N. melanobasilarus* Hsu [squares], and *N. megostiellus* Hsu [triangles].

ETYMOLOGY: This species is named in honor of Dr. R. W. Hodges, formerly

of the Systematic Entomology Laboratory, USDA, U.S. National Museum of Natural History, a leading microlepidoptera biosystematist, who made one of the largest collections of this species.

Neoheliodines megostiellus Hsu, new species
(Figs. 9, 68, 117, 180)

MALE. FW length 4.6 mm (n = 1). **Head:** Frons, vertex, antenna metallic dark gray. Scaling behind eyes buff. Labial palpus cream-yellow with distal tip tinged with metallic gray. **Thorax:** Metallic dark gray tinged with purple or green. Legs metallic dark gray with inner surfaces partially cream-yellow. A pair of faint metallic black patches on metatibia. Areas adjacent to spurs buff. Posterior surfaces of spurs buff. Inner medial spur of metatibia 2.0 X longer than outer. **Forewing:** Metallic chrome orange with strongly curved metallic gray outer margin; 4 costal and 3 dorsal metallic gray spots; size formula: C3 > C2 > C4 > C1; D3 > D1 > D2, D3; C4 and D3 fused with metallic gray of outer margin, which is broadly margined inwardly by black extending around tornus to D3. Spots variably edged by purplish black. Basal area with purplish black along costa and dorsum. Fringe uniformly metallic gray. **Hindwing:** Uniformly metallic pale gray tinged with orange. Fringe uniformly metallic gray. **Abdomen:** Metallic dark gray with subdistal area buff-yellow. **Genitalia:** As in Fig. 68 (drawn from holotype, YFH slide 1057, SDNHM; n = 1). Tegumen short; distal end forming a flat sheet with two pointed distal corners. Socii digitate with blunt distal end, approximately 1.4 X tegumen length. Saccus approximately 2.6 X tegumen length. Valva elongate, bulged distally. Phallus approximately 1.6 X tegumen + saccus, slightly curved upward near distal end, with 2 prominent teeth, one hooked downward, one pointing parallel with body axis.

FEMALE. FW length 4.5 mm (n = 2). Color pattern as described for male. **Genitalia:** As in Fig. 117 (drawn from YFH slide 0725, SDNHM; n = 2). Medial band of apophyses anteriores broad with blunt posterior end. Sclerotized ring around ostium bursae well developed, short, very wide, length 0.4 X width, cylindrical, combined with posterior part of ductus bursae forming a funnel-like structure. Signum with distal finer portion 1.15 X the length of proximal portion. Appendix bursae absent.

TYPE MATERIAL: Holotype: ♂: **MEXICO: JALISCO:** Los Pozos, 8 mi S Acatlan, 4700', 15.IX.1986 (D. K. Faulkner, SDNHM).

2♀ paratypes: **MEXICO: JALISCO:** 1♀, La Floresta, Lago de Chapala, 4.IX.1977, 1510 m (E. Schlinger, UCB); 1♀, same data as holotype.

GEOGRAPHIC RANGE: (Fig. 9) Mexico (Jalisco).

ETYMOLOGY: An adjective of Greek origin, from *mega* = large, plus a noun of Latin origin, *ostium* = door.

Neoheliodines melanobasilarus Hsu, new species
(Figs. 9, 69, 118, 181)

MALE. FW length 3.8-4.0 mm (n = 2). **Head:** Metallic gray with hood-like scale band posterior to vertex brown to white. Scaling behind eyes white. Antenna metallic gray with white tip. Labial palpus white with metallic gray tip. **Thorax:** Metallic gray tinged with bluish green. Legs metallic gray with two metallic black patches on metatibia. Inner medial spur of metatibia about 1.9 X longer than outer. **Forewing:** Metallic chrome orange with nearly linear metallic outer margin; 5 costal and 3 dorsal metallic gray spots with size formula: C3 > C2 > C4 > C5 > C1; D3 > D1 > D2. Metallic reddish black along outer margin and spots, extensively around basal half of wing. C4 and D3 sometimes fused into linear band. Fringe uniformly metallic gray. **Hindwing:** Metallic black tinged with orange. Fringe uniformly metallic gray. **Abdomen:** Metallic black banded with metallic gray, distal end white. **Genitalia:** As in Fig. 69 (drawn from holotype; n = 1). Tegumen with posterior projecting bump. Socii digitate with blunt, slightly enlarged distal end, approximately 1.5 X tegumen length. Saccus approximately 4.7 X tegumen length. Valva elongate, slightly curved upward, venter bulged with obtuse distal end. Phallus curved upward, with two ovate lobes distally, approximately 1.8 X longer than tegumen + saccus.

FEMALE. FW length 4.2 mm (n = 1). Color pattern as described for male. **Genitalia:** As in Fig. 118 (drawn from YFH slide 0883, Texas, USNM; n = 1). Medial band of apophyses anteriores broad with blunt posterior end. Sclerotized ring around ostium bursae short, wide, cylindrical, combined with distal portion of ductus bursae forming funnel-like structure. Signum with distal finer portion approximately 2.0 X proximal portion. Appendix bursae absent.

TYPE MATERIAL: Holotype:♂: **MEXICO: SAN LUIS POTOSÍ:** 6 mi E Matchuala, 5300', "21.X.1976" [label error = 21 September 1976], collected from *Parthenium hysterophorus* [Asteraceae] (J. A. Powell and J. A. Chemsak, UCB).

1♂, 1♀ paratypes: **MEXICO: SAN LUIS POTOSÍ:** 1♂, same data as holotype. **U.S.A.: TEXAS: DALLAS Co.:** 1♀, Dallas, 4.X.1907 (R. A. Cushman, USNM).

GEOGRAPHIC RANGE: (Fig. 9) U.S.A. (Texas); Mexico (San Luis Potosí).

ETYMOLOGY: An adjective of Greek origin, *melanos* = black, plus an adverb of Greek origin, *basilaris* = at the base.

BIOLOGY: Two males were collected from flowers of *Parthenium*

hysterophorus L. (Asteraceae), presumably a nectar source unrelated to the larval host plant.

Neoheliodines vernius Hsu, new species
(Figs. 10, 70, 119, 152-154, 157, 163, 182)

Heliodines sexpunctella; Busck (not Walsingham), 1910a: 183.

MALE. FW length 3.1-4.1 mm (3.60 ± 0.27 mm, n = 30). **Head:** Frons, vertex metallic dark gray. Scales behind eyes dark brown. Antenna metallic gray with white distal tip. Labial palpus metallic dark gray with buff-yellow base. **Thorax:** Metallic dark gray. Legs metallic dark gray with prominent metallic black patch in front of spurs. Area adjacent to distal spurs frequently whitish. Inner medial spur of metatibia approximately 1.90 X longer than outer. **Forewing:** Metallic chrome orange with metallic gray outer margin; 5 costal and 3 dorsal metallic gray spots with size formula: $C3 > C2 > C5 \geq C4 > C1$; $D3 > D1 > D2$. Spots variably edged by black. Basal area with extensive black along costa up to C4 and along dorsum up to D2. Fusion between metallic gray spots frequent. Ends of outer margin fused with C5, D3. Fringe uniformly gray. **Hindwing:** Metallic pale black with basal half paler. Fringe uniformly gray. **Abdomen:** Metallic dark gray, terminal end often to buff-yellow or cream-white. **Genitalia:** As in Fig. 70 (drawn from EME slides 3607 and 3604, Inyo Co., Calif.; n = 36). Tegumen cup-like with truncate distal end. Socii oval, with distal end truncate from lateral view, approximately 0.4 X tegumen length. Saccus approximately 2.6 X tegumen length. Valva broad, elongate, somewhat triangular with distal half tapering to a blunt end. Phallus slightly curved down, a dorsal membranous sac at distal end, approximately 1.5 X longer than tegumen + saccus.

FEMALE. FW length 3.0-4.3 mm (3.69 ± 0.30 mm, n = 30). Color pattern as described for male. **Genitalia:** As in Fig. 119 (drawn from EME slide 3846, Inyo Co., Calif.; n = 25). Ventral bridge of apophyses anteriores with blunt posterior margin. Sclerotized ring around ostium bursae elongate, bell shaped. A ventral sclerotized patch immediately posterior to ostium bursae. Signum with distal finer portion 2.3 X proximal portion. Appendix bursae present.

TYPE MATERIAL: Holotype: ♂: **U.S.A.: CALIFORNIA: SAN DIEGO Co.:** 2 mi NE Lakeside, 24.III.1993, reared from *Mirabilis californica*, emgd. 2.V.1993 (Y.-F. Hsu, UCB).

128♂, 125♀ paratypes: **MEXICO: BAJA CALIFORNIA NORTE:** 1♂, 5.7 mi E Hamilton Ranch, Arroyo Santo Domingo, dam site, 23.IV.1963 (H. B. Leech, P. H. Arnaud, CAS); 2♂, Sierra de Juarez, "Narrows" mouth of Cantillas Cyn., 21.III.1967 (Powell, UCB); 1♂, 7 mi SE Maneadero, 100', 25.III.1973 (Powell, UCB); 2♂, 1♀, 3 mi NW Rancho Santa Ynez, 27.III.1973, associated with *M. californica*

(Powell, UCB); 2♂, 2♀, 37 mi NW Bahia de Los Angeles, Desengano, 1.IV.1973 (S. L. Szerlip, Powell, Doyen, UCB); 1♂, 3♀, 10 mi SE El Rosario, 31.III.1976, associated with *M. laevis* [= *californica*] (Doyen, UCB); 3♂, 4♀, Isla de Cedros, vicinity El Pueblo, 4.IV.1983 (J. Brown and D. Faulkner, SDNHM); 2♂, 2♀, 3 km N Bajamar, 500', 21.III.1993, associated with *M. californica*, 2♂, 4♀, 21.III.1993,

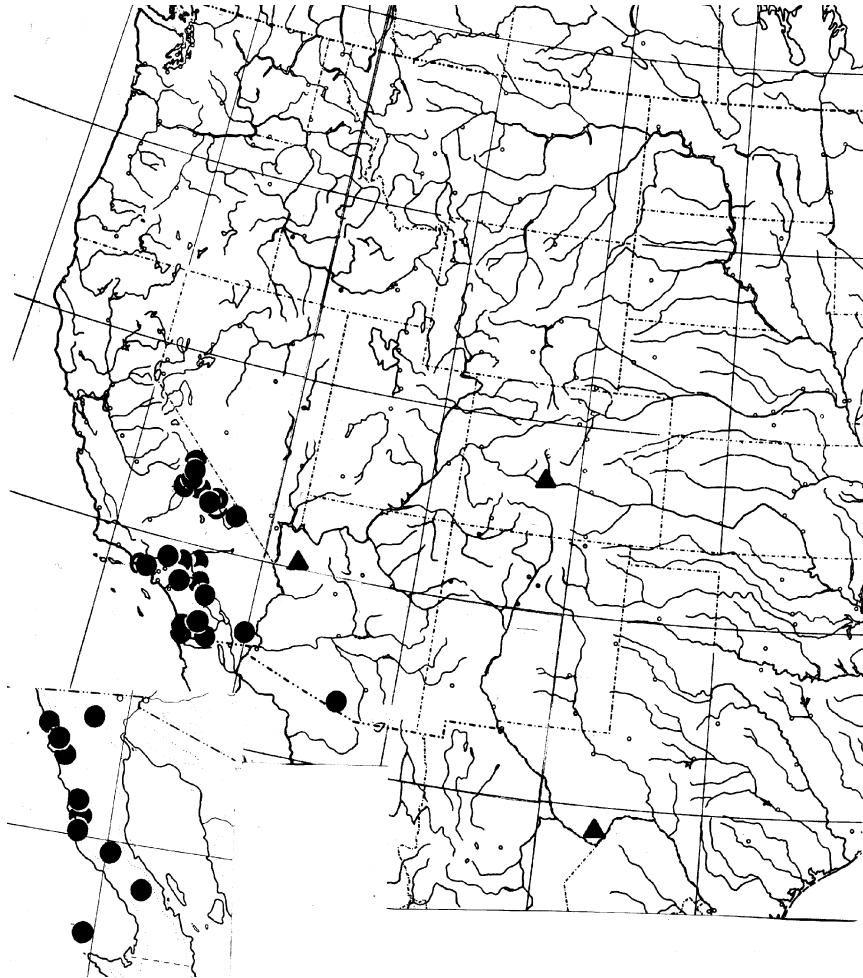

Fig. 10. Map of the southwestern Nearctic (inset of Baja California Norte to left, slightly enlarged) showing distribution records for *Neoheliodines vernius* Hsu [circles] and *N. albidentus* Hsu [triangles].

reared from *M. californica*, emgd. 17-20.IV.1993, JAP 93C5 (Y.-F. Hsu, UCB), 2♂, 1♀, 1 km S Sto. Tomás, 600', 21.III.1993, 2♂, 4♀, 21.III.1993, reared from *M. californica*, emgd.

19.IV to 4.V.1993, 1♂, 2♀, emgd. 1-4.III.1994, JAP 93C7 (Hsu, UCB); 1♂, 1♀, SE Catavina, 2200', 22.III.1993, associated with *M. californica*. (Hsu, UCB).

U.S.A.: ARIZONA PIMA Co.: 3♀, Coyote Mts, 4500', 3.V.1993, reared from *M. bigelovii*, emgd. 29.V to 17. VI.1993, 3♂, 1♀, emgd. 28.II to 3.III.1994, 1♂, emgd.

23.II.1995, JAP 93E9 (Hsu, UCB). **CALIFORNIA: IMPERIAL Co.:** 1♀, 2 mi W Glamis, 22.IV.1978 (J. W. Brown, D. K. Faulkner, SDNHM); 15♂, 17♀, 2 mi E Mountain Springs, 1100', 18.III.1994, associated with *M. tenuiloba* (Hsu, H. H. Chuah, UCB & UCONN).

INYO Co.: 1♀, Argus Mts. (C. V. Riley, USNM); 4♂, 2♀, Mazourka Cyn., 8 mi NE Independence, 11.V.1969, on *Mirabilis* (P. A. Rude, UCB); 1♂, 2♀, same locality, 11.V.1969, on *Gilia latifolia*, 3♂, 3♀, 11.V.1969, 5♂, 3♀, 15.V.1969, associated with *Mirabilis bigelovii* (all Powell, UCB); 2♂, same locality, 10.V.1969 (J. A. Chemsak, UCB); 4♂ + 1 ex, Inyo Mts., 15 mi NE Independence, 6500', 11.V.1969 (J. T. Doyen, UCB); 9♂, 3♀, 6 mi W Westgard Pass, 16.V.1969 (Doyen, UCB); 14♂, 9♀, 2 mi SW Lone Pine, Tuttle Cr., 9/10.V.1969, associated with *M. bigelovii* (P. A. Rude, P. A. Opler, Powell, UCB); 1♂, 1♀, same locality, 16.V.1969, associated with *M. bigelovii* (Powell, UCB); 2♀, Wildrose Station, 14.V.1969 (Doyen, UCB); 1♂, Panamint Mts., Surprise Cyn., 24.IV.1957 (G. I. Stage, UCB); 2♂, 3♀, Salsberry Pass, 3315', 25.IV.1992, associated with *M. bigelovii* (Hsu, UCB); 4♂, 1♀, Long John Cyn., 4400-4800', 28.IV.1994 (M. E. McIntosh, UCB).

LOS ANGELES Co.: 7♂, 9♀, Lovejoy Buttes, 5 mi. N Pearblossom, 20.IV.1941 (J. A. Comstock, USNM, LACM); 7♂, 2♀, same locality, 12.IV.1964 (R. L. Langston, UCB); 2♀, 3 mi SE Calamigos, 16.III.1967 (Powell, UCB); 1♀, 2 mi NW Valyermo, 1♂.V.1968, associated with *M. californica* (P. A. Opler, UCB); 1♀, 4 mi NW Topanga, 5.IV.1963 (Powell, UCB). **RIVERSIDE Co.:** 1♀, Morongo Vy., 3000', 19.IV.1955 (W. R. M. Mason, CNC); 3♂, 3♀, Palm Desert, 17.III.1975 (B. Wharton, TXAM); 1♂, 1♀, 5 mi N Riverside, 29.III.1977, on *M. laevis* [= *californica*] (Powell, UCB).

SAN BERNARDINO Co.: 2♀, Victorville, 2700', 24.IV.1992, associated with *M. bigelovii* (Hsu, UCB); 2♂, Granite Mtn., 3100', 22.III.1994, associated with *M. bigelovii*; 1♂, Calico Mts., Odessa Cyn., 21.III.1994 (both Hsu, Chuah, UCB). **SAN DIEGO Co.:** 1♂, 2 mi NE Lakeside, 29.III.1961, 4♂, 8♀, 13.III.1963, on *M. laevis* [= *californica*], 3♂, 6♀, 7.III.1993, associated with *M. californica* (all Powell, UCB and UCONN); 1♂, 3♀, same locality, 24-25.III.1993, associated with *M. californica*, 2♂, 3♀, 24.III.1993, reared from *M. californica*, emgd. 18.IV to 4.V.1994, JAP 93C12, 1♂, 1♀, 27.IV.1993, associated with *M. californica* (all Hsu, UCB and UCONN); 3♂, 2♀, 1 mi E Lower Otay Reservoir, Little Cedar Cyn., 520', 17.III.1994, associated with *M. californica* (Hsu, Chuah, UCB and UCONN); 2♂, 4♀, 9 mi SW Scissors Crossing, Box Cyn., 2400', 19.III.1994, associated with *M. bigelovii* (Hsu, Chuah, UCB and UCONN).

GEOGRAPHIC RANGE: (Fig. 10) U.S.A. (Arizona, California); Mexico (Baja California).

ETYMOLOGY: An adjective of Latin origin, *vernus* = spring, so named because it flies in the spring months.

BIOLOGY: The confirmed larval host plants are Nyctaginaceae: *Mirabilis californica* A. Gray in California and Baja California and *M. bigelovii* A. Gray in Arizona. In addition, adults have been collected in California associated with probable host plants, *M. bigelovii* and *M. tenuiloba* S. Watson. The larva bores into flower buds and young fruits. Pupation probably occurs in debris near the host. This species likely is bivoltine or multivoltine because larvae from a given collection have produced both non-diapausing and diapausing pupae. Pupae that do not emerge after June are in diapause, spending the summer, fall, and winter as nearly naked pupae. In confinement, moths emerged from the diapausing pupae in February, March, April, and May of the following spring (n = 12)(JAP 93C7, 93C12, 93E9) and in the second spring (n = 1)(JAP 93E9). Adults visit flowers of the host plants and occasionally other flowers. When associated with *M. tenuiloba*, however, adults were observed nectaring at night even after 10:00 P.M. PST in March because, its flowers open at night. In this case the moths essentially are still diurnal. They fly actively and mate during the day; the nocturnal activity seems to be solely for feeding. The adult does not raise its hind legs in repose.

PARASITISM: The following species were found parasitizing this moth: unidentified Campopleginae species (Ichneumonidae)(JAP 93C5); *Chrysocharis* sp. (Eulophidae)(JAP 93C5); unidentified Tachinidae (JAP 93C12).

Neoheliodines cliffordi (Harrison and Passoa), new combination
(Figs. 11, 71, 120, 183)

Heliodines cliffordi Harrison and Passoa, 1995: 63.

MALE. FW length 3.8-5.0 mm (4.53 ± 0.28 , n = 18). **Head:** Metallic dark gray with hood-like scale band posterior to vertex buff-yellow. Scaling behind eyes buff-yellow. Antenna metallic dark gray with white tip. Labial palpus buff with distal segment metallic dark gray. **Thorax:** Metallic gray with distal ends of coxae buff-yellow. Legs metallic dark gray on outer surfaces, partially pale silvery gray on inner surfaces. Areas around spurs silvery gray, sometimes mixed with cream-yellow around distal spurs. Spurs with outer surfaces silver, inner surfaces pale buff-yellow. Metatibia with two metallic black patches. Inner medial spur of metatibia approximately 2.3 X longer than outer. **Forewing:** Metallic chrome orange with basal area yellow; outer margin forming a broad metallic gray patch with a large indented metallic gray tooth; 5 costal and 3 dorsal metallic gray spots, generally bar shaped except elongate, triangular C5. Size of spots variable, basic formula as C3 > C5 > C2 > C4 > C1; D3 > D1 > D2, sometimes C5 larger than C3, D2 larger than D1. Metallic black around both ends of outer margin. Basal area with metallic black along costa up

to C3 and along dorsum to D1. Fringe uniformly metallic gray. **Hindwing:** Uniformly metallic pale black tinged with orange. **Abdomen:** Metallic dark gray with distal tip buff. **Genitalia:** As in Fig. 71 (drawn from slide YFH 1029, Illinois, USNM; n = 4). Tegumen cylindrical, with distal end protruded into a cone. Socii oblong, flat, approximately 0.4 X tegumen length. Saccus approximately 3.7 X tegumen length. Valva elongate, curved upward with acute distal end; basal half bulged into a lobe ventrally. Phallus approximately 1.7 X longer than tegumen + saccus, distal half slightly curved down; two longitudinal rows of minute, ventral teeth at distal tip.

FEMALE. FW length 3.8-4.8 mm (4.31 ± 0.27 mm, n = 30). Color pattern as described for male. **Genitalia:** As in Fig. 120 (drawn from allotype, YFH slide 0828, Illinois, USNM; n = 3). Ventral bridge with blunt distal end. Sclerotized ring around ostium bursae reduced to a small circle. Signum short, barely over half the length of corpus bursae, distal finer portion approximately 0.85 X length of proximal portion. Appendix bursae present.

TYPE MATERIAL: Holotype: ♂: U.S.A.: ILLINOIS: COLES Co.: Charleston, T12N, R9E, NW1/4, Sect. 11, 14.VI.1992, reared from *Mirabilis nyctaginea*, emgd. 30.VI.1992 (T. Harrison, USNM).

PARATYPES EXAMINED: U.S.A.: ILLINOIS: CHAMPAIGN Co.: 4♂, 4♀, T19N, R9E, NW1/4, Sect. 13, 1.VI.1994, reared from *Mirabilis nyctaginea*, emgd. 20-23.VI.1994 (T. Harrison, UCB). COLES Co.: 1♂, 1♀, Charleston, T12N, R9E, NW1/4, Sect. 11, 8.VI.1990, reared from *Mirabilis nyctaginea*, emgd. 22.VI.1990 (T. Harrison, USNM), 7♂, 3♀, 6.VI.1994, emgd. 20-24.VI.1994 (T. Harrison, UCB).

ADDITIONAL SPECIMENS EXAMINED: U.S.A.: ILLINOIS: PUTNAM Co.: 1♂, 27.VII.1974; 1♀, 21.VIII.1971 (M. O. Glenn, USNM). IOWA: STORY Co.: 1♀, Ames, 25.V.1959 (D. V. Sisson, USNM). KANSAS: OSAGE Co.: 1♀, 10 mi S Lyndon, 6.V.1966 (G. F. Hevel, USNM).

GEOGRAPHIC RANGE: (Fig. 11) U.S.A. (Illinois, Iowa, Kansas); also New Mexico according to Harrison and Passoa (1995), which may refer to *N. arizonense* by present concepts.

BIOLOGY: The biology of the species in Illinois has been reported in detail by Harrison and Passoa (1995) and is summarized as follows. The larval host is *Mirabilis nyctaginea*. The larva has four instars, feeding as a leaf miner in the first two, turning to an underside leaf skeletonizer in the 3rd and 4th instars, rarely also feeding on the upper side of leaves. Overwintering probably occurs in the pupal stage. This species

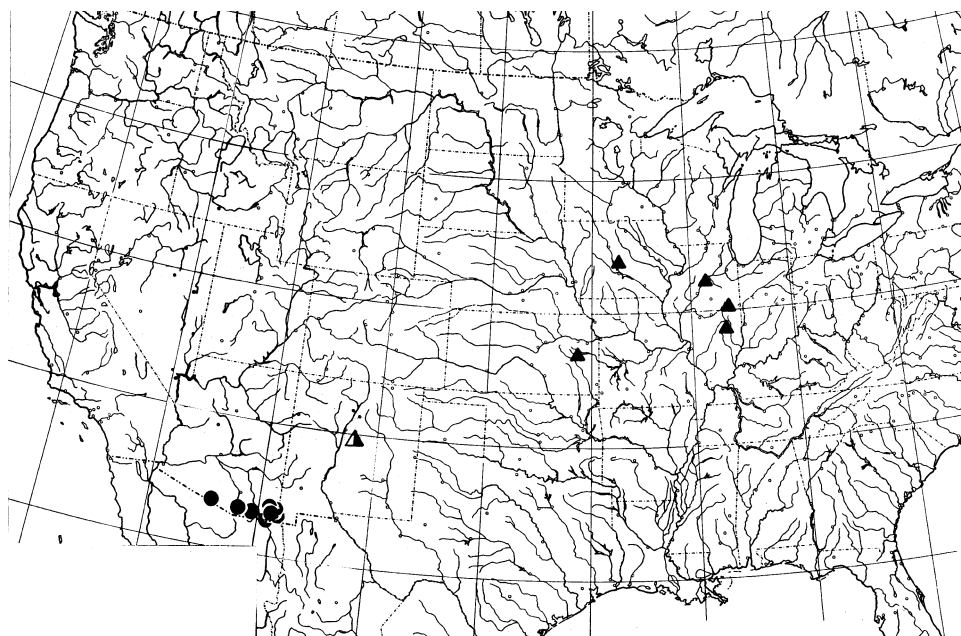

Fig. 11. Map of the United States showing distribution records for *Neoheliodines arizonense* Hsu (circles) and *N. cliffordi* (Harrison and Passoa) [triangles]; half-open triangle indicates record of *cliffordi* in New Mexico (Harrison and Passoa 1993), which probably represents *arizonense* according to present concepts.

was estimated to have four generations per year (Harrison and Passoa 1995). The adult does not raise its hind legs in repose.

Neoheliodines arizonense Hsu, new species
(Figs. 11, 72, 121, 184)

MALE. FW length 3.9-5.6 mm (4.71 ± 0.53 mm, $n = 7$). **Head:** Metallic gray with hood-like scale band posterior to vertex yellow to yellowish white. Scaling behind eyes pale buff-yellow. Labial palpus pale yellowish white. **Thorax:** Metallic gray with distal ends of coxae white. Legs metallic gray on outer surfaces, pale silvery gray on inner surfaces. Areas around spurs cream-yellow. Spurs cream-white. Metatibia with two obscure metallic black patches; inner medial spur of metatibia about 2.4 X longer than outer. **Forewing:** Metallic spectrum or chrome orange with basal area yellow; outer margin forming a broad metallic gray patch with a prominent, elongate, indented, metallic gray tooth narrowly edged with black; 5 costal and 3 dorsal metallic gray spots, generally bar shaped except triangular C5. Size of spots variable, basic formulas: $C3 > C5 > C2 > C4 > C1$; $D3 > D1 > D2$; sometimes D2 larger than D1. Metallic black around both ends of outer margin. Basal area with

metallic black along costa up to C3 and along dorsum to D1. Fringe metallic gray, sometimes white around D3 spot. **Hindwing:** Uniformly metallic pale black tinged with orange. **Abdomen:** Metallic dark gray with distal end brown and subapical area white. **Genitalia:** As in Fig. 72 (drawn from EME slide 3625, Arizona.; n = 3). Tegumen cylindrical with concave distal end. Socii flattened laterally, somewhat square, approximately 0.65 X tegumen length. Saccus approximately 4.15 X tegumen length. Valva elongate, up-curved with acute distal end, basal half enlarged into a lobe ventrally. Phallus with distal half strongly up-curved with pointed end, approximately 1.65 X longer than tegumen + saccus; two longitudinal rows of minute, ventral teeth at distal end.

FEMALE. FW length 4.0-4.9 mm (4.48 ± 0.32 , n = 8). Color pattern as described for male. **Genitalia:** As in Fig. 121 (drawn from YFH slide 0884, Arizona, CAS; n = 4). Ventral bridge of apophyses anteriores narrow with acute posterior end. Sclerotized ring around ostium bursae slightly elongate, cup-like. Signum long, reaching beyond 2/3 length of corpus bursae, with distal finer portion about as long as proximal portion. Appendix bursae present.

TYPE MATERIAL: Holotype: ♂: **U.S.A.: ARIZONA: COCHISE Co.:** Cave Cr., 2 mi SW Portal, 20-23.VIII.1972, at black light (D. Veirs and J. Powell, UCB).

12♂, 16♀ paratypes: **U.S.A.: ARIZONA: COCHISE Co.:** 1♀, Huachuca Mts., Carr Cyn., 5000', 2.IX.1978, UV light (R. S. Wielgus, USNM); 1♂, same locality, 30.VII.1986 (D. L. Wagner, UCONN) 1♀, Carr Cyn., 5300', Huachuca Mtns., 29.VII.1986, reared from *Mirabilis longiflora*, emgd. 23.VIII.1986, DLW lot 86G104 (D. L. Wagner, UCONN); 6♂, 7♀, Carr Cyn., 5000', Sierra Vista, Huachuca Mts., reared from *Mirabilis*, emgd. 21.VII. to 20.VIII. + DOA IX.1988, DLW 88H84 (R. Wielgus, UCONN); 1♀, Douglas, "7/8.[19]33" (W. W. Jones, USNM); 1♀, 8 km W Portal, 1645 m, Southwestern Research Sta., 19.IX.1966 (P. H. Arnaud, CAS); 1♂, 1♀, Chiricahua Mts., Cave Creek Cyn., 9.VIII.1986, on *Mirabilis* (D. Frack, UCONN); 2♀, 1 mi S Portal, Stewart Camp, 23-25.VIII.1971, Malaise Trap (J. T. Doyen, UCB); 1♂, South Fork of Cave Cr., Coronado NF, 5000', 13.VIII.1975 (CDF, LACM). **PIMA Co.:** 1♂, San Miguel, 4.VIII.1991 (M. A. Prentice, UCB). **SANTA CRUZ Co.:** 2♀, Santa Rita Mts., Madera Cyn., 4880', 4-6.IX.1959 (R. W. Hodges, USNM); 2♂, same locality, 1-3.VIII.1970 (P. Rude, UCB).

GEOGRAPHIC RANGE: (Fig. 11) U.S.A. (Arizona, New Mexico?) And possibly Mexico. *Neoheliodines cliffordi* was reported from New Mexico by Harrison and Passoa (1995), based on a specimen that presumably is referable to *arizonense*.

BIOLOGY: This species has been reared from larvae found on *Mirabilis longiflora* L. (Nyctaginaceae) in southern Arizona in late July and from an unidentified *Mirabilis* in July. Adults were collected at several localities in southern Arizona in late July, August, and September, suggesting that there may be two

generations, beginning before the onset and during the rainy season, when *Mirabilis* is in foliation.

ETYMOLOGY: Named after the state of Arizona, where the entire type series was taken.

REMARKS: *Neoheliodines arizonense* is undoubtedly the sister species of *N. cliffordi*, which is very similar in morphology. The tegumen is concave distally in *arizonense*, protruded into a cone in *cliffordi*, while the base of the ductus bursae is a small ring in the latter species but is cup-like in *arizonense*. One specimen (abdomen missing) from "Mexico" (LACM) could belong to this taxon.

Neoheliodines albidentus Hsu, new species
(Figs. 10, 73, 185)

MALE. FW length 4.0-4.9 mm (4.3 ± 0.31 mm, $n = 6$). **Head:** Frons, vertex, antenna metallic gray. Scaling behind eyes white. Labial palpus metallic pale gray, base white. **Thorax:** Metallic gray. Legs metallic gray with distal ends of coxae white. Spurs white on inner side, black on outer. Metatibia with two metallic black patches. Areas adjacent to spurs white. Inner medial spur of metatibia 2 X longer than outer. **Forewing:** Metallic orange with basal 1/3 yellow; outer margin forming a narrow metallic gray band edged with black; 6 costal and 3 dorsal spots, all metallic gray with shape somewhat square except white, triangular tooth-shaped C5. D3 sometimes also partially white; size formula: $C3 \geq C6$, $C2, C4, C5 > C1$; $D3 > D2 > D1$. Spots edged with black. Basal area with extensive metallic reddish black along costa up C4 and along dorsum to D1. Fringe metallic gray with area adjacent to D3 white. **Hindwing:** Uniformly metallic gray. Fringe uniformly metallic gray. **Abdomen:** Metallic black slightly banded with metallic gray, distal end whitish. **Genitalia:** As in Fig. 73 (drawn from YFH slide 1030, Arizona, USNM; $n = 3$). Tegumen cone shaped. Socii oblong, extremely short, approximately 0.4 X tegumen length. Saccus approximately 3.4 X tegumen length. Valva elongate with blunt distal end; medial portion slightly wider than both ends. Phallus with narrow distal end, approximately 1.3 X length of tegumen + saccus.

FEMALE. Unknown.

TYPE MATERIAL: Holotype:♂: **U.S.A.: ARIZONA: MOHAVE Co.:** Hualapai Mountain Park, 2.VI.1968, black and white lights (P. A. Opler and J. A. Powell, UCB).

5♂ paratypes: **U.S.A.: ARIZONA: MOHAVE Co.:** 1♂, Hualapai Mt. Park, 30.VI.1986 (J. W. Brown, UCB); 1♂, Hualapai Mts., 16.V.1923 (USNM); 1♂, same locality, 16.IX.1923 (USNM). **COLORADO: CHAFFEE Co.:** 1♂, 1 mi S Poncha Spring, 6.VII.1982, pinyon-juniper, oak-cottonwood (R. W. Hodges, USNM).

TEXAS: BREWSTER Co.: 1♂, Big Bend Natl. Park, The Basin. V.22.1959 (M. MacKay, CNC).

GEOGRAPHIC RANGE: (Fig. 10) U.S.A. (Arizona, Colorado, Texas).

ETYMOLOGY: An adjective of Latin origin, *albus* = white, plus Latin noun, *dentis* = tooth.

Aetole subassemblage

Diagnosis: Hind legs elevated 45° or beyond in repose (but the habit lost in *Embola ionis*). Distal end of saccus swollen into a round club (but reduced or modified into irregularly shaped club in genus *Aetole*).

EMBOLA Walsingham
(Figs. 12-15, 32, 44, 74-85, 122-128, 161-162,
167, 170, 186-196)

Embola Walsingham, 1909: 3.

Type species: *Embola xanthocephala* Walsingham, 1909: 3; by original designation. Gender feminine.

Crembalastis Meyrick, 1915: 214. NEW SYNONYMY.

Type species: *Crembalastis erythorma* Meyrick, 1915: 214; by original designation. Gender feminine.

Diagnosis: Scales behind eyes long, filiform. Coremata containing filiform scales. Signa dimorphic, one elongate or ovate, the other circular. Pupa with lateral ridges greatly reduced.

Included species: *E. albaciliella* (Busck, 1910), new combination; *E. autumnalis* Hsu, new species; *E. ciccella* (Barnes and Busck, 1920), new combination; *E. cyanozostera* Hsu, new species; *E. dentifer* Walsingham, 1909; *E. friedlanderi* Hsu, new species; *E. ionis* (Clarke, 1952), new combination; *E. melanotela* Hsu, new species; *E. obolarcha* (Meyrick, 1909), new combination; *E. powelli* Hsu, 2002; *E. sexpunctella* (Walsingham, 1892), new combination; *E. xanthocephala* Walsingham, 1909.

Head: Scales behind eyes long, filiform. Antennae as long as FW length. **Thorax:** A row of filiform scales along lateral cervical sclerites. Inner medial spur of metatibia at least 2 X longer than outer. Metatibia without ventral and terminal filiform scales

around spurs. **Forewing:** (Fig. 32) 11 veins, R1 and R2 forked with Rs; other R veins all separate. Retinaculum of female a series of arched hairs. Ground color orange to scarlet with a narrow metallic gray, black, or silver distal margin. Several costal and dorsal metallic gray or silver spots present, replaced by metallic gray transverse bands in certain species. **Hindwing:** 6 veins, all separate except Cu veins. Frenulum of female a single bristle. **Abdomen:** (Fig. 44) A8 of male weakly sclerotized with an elongate

sclerotized tergum. Pleura and sternum largely membranous with posterior end of pleura forming weakly sclerotized, paired, semicircular lobes. A pair of ventrolateral coremata in male, forming elongate pouches containing a bundle of long filiform scales. **Male genitalia** (Figs. 74-85): Tegumen stout, forming somewhat elongate sclerotized sac. Widely separated socii simple, stout, moderately setose reniform or cone- or horn-shaped. Saccus slender, extremely elongate, more than 3 X longer than tegumen. Valva simple, elongate. Aedeagus slender, attenuate posteriorly into a sharp distal end; minute processes externally at distal end in several species. Bulbus ejaculatorius abruptly narrowed, attenuate to a lanceolate tip, connected with phallobase subterminally. Cornuti absent or present, in form of scattered minute teeth. **Female genitalia** (Figs. 122-128): Ventral bridge of apophyses anteriores rectangular or oval, disk-like. Ductus bursae longer than corpus bursae. Ductus seminalis originating at anterior portion of ductus bursae. Signa double, of different shapes; one larger, elongate or ovate, situated dorsally on corpus bursae immediately anterior to junction with ductus bursae; the other smaller, circular or oval, on ventral wall. **Early stages:** Larva with two SV setae on A9. Pupa cylindrical, with lateral edges greatly reduced (Figs. 167, 170), evidently related to life as a tunnel maker in stems. Three lateral bristles from A2 to A7.

Embola has been treated as a synonym of *Lamprolophus* Busck, 1900 (Heppner 1984) but was resurrected to accommodate the species assigned in this study (Hsu 2002). *Cremaalastis* Meyrick, a monotypic South American genus, was proposed for *C. erythorma* Meyrick, a species that possesses dark fuscous wings (Meyrick 1915). The genitalia of both sexes of *C. erythorma* (Figs. 79, 126), however, are very similar to those of *Embola friedlanderi* Hsu (Figs. 78, 125). We propose synonymy of *Cremaalastis* with *Embola*.

Monte (1934) and Lima (1936, 1945, 1968) reported that the South American ‘*Heliodines obolarcha*’ (Meyrick) feeds in cecidomyiid galls on *Piper* spp. We assign *obolarcha* to *Embola* (Table 1), but the identifications of the moths in Monte’s and Lima’s records are yet to be verified.

Lamprolophus of the Caribbean region is the only other heliodinid known to feed as a stem borer. The larvae of *L. lithella* Busck usually infest young shoots and are gregarious in thicker stems (JAP 94D98). However, there is no reduction of the lateral ridges on the pupa (Fig. 164), suggesting that *Lamprolophus* is not closely related to *Embola*. The proposed phylogeny for Heliodinidae (Fig. 1) is consistent with this hypothesis, and the stem boring strategies shown by *Lamprolophus* and *Embola* are not homologous (Hsu, 2002). The adults of some *Embola* species raise the hind legs

in repose, but others do not.

Larval hosts are Nyctaginaceae (Order Caryophyllales) and, in South America, Piperaceae (Order Piperales) according to Monte (1934) and Lima (1936, 1945, 1968). We did not examine specimens reared from Piperaceae to confirm this identification.

KEY TO SPECIES OF *Embola* OF NORTH AND CENTRAL AMERICA

1. Metallic gray FW markings limited to only a transverse band . . . *cyanozostera*
Metallic gray FW markings forming a series of spots, sometimes in addition to a transverse band 2
2. Metallic gray transverse band present at 1/3 from FW base *powelli*
No transverse band on FW 3
3. Apical tip of antenna gray 4
Apical tip of antenna white or cream colored 8
4. HW fringe uniformly white *albiciliella*
HW fringe at least partially gray or brown 5
5. Hood-like scaling behind vertex black 6
Hood-like scaling behind vertex orange or yellow 7
6. FW bright orange with 6 costal metallic gray spots tinged with green, a basal black streak. Tegumen concave at caudal end; *socii* reniform *friedlanderi*
FW yellow-orange with 5 costal metallic gray spots, black along costa to middle and around base to dorsum. Tegumen dome-shaped caudally; *socii* attenuated distally *ionis*
7. Labial palpus metallic gray. *Socii* slender, narrowed apically *dentifer*
Labial palpus metallic buff-yellow. *Socii* broadly rounded apically
. *xanthocephala*
8. FW length 5.5 mm, usually greater. HW fringe gray or brown, paler basally or toward tornus 9
Smaller moths, FW length rarely up to 5.5 mm. HW fringe uniformly gray 10
9. Scaling of vertex partially buff-yellow; metallic gray FW spots tinged with green or purple. Distal end of *socii* acute. Large, FW 6.5-8 mm *ciccella*
Scaling of vertex entirely gray; metallic FW spots lead colored. Distal end of *socii* blunt. Smaller moth, FW length 5.5 mm *autumnalis*

10. FW with 5 costal metallic gray spots. Caudal end of tegumen concave
 *melanotela*
 FW with 4 costal metallic gray spots. Caudal end of tegumen attenuate, beak-
 shaped *sexpunctella*

Embola ionis (Clarke), new combination
 (Figs. 12, 32, 74, 122, 186)

Heliodines ionis Clarke, 1952: 138; Wester, 1956: 43; Heppner and Duckworth,
 1983: 28 (checklist); Harrison and Passoa, 1995: 68.

MALE. FW length 3.6-4.8 mm (4.27 ± 0.39 mm, n = 6). **Head:** Frons metallic black, vertex metallic gray. Hood-like scale band posterior to vertex metallic black. Antenna metallic black. Labial palpus cream colored with dark apical tip. **Thorax:** Metallic black. Legs metallic black. Metatibia with areas around spurs metallic gray. Inner medial spur of metatibia 3.0 X longer than outer. **Forewing:** Metallic chrome orange with metallic gray outer margin; 6 costal and 3 dorsal metallic gray spots tinged with green. Size formula of FW spots $C3 > C2 > C4 > C1 \geq C5 > C6$, $C3 > D1 > D2$. A basal black streak. Spots edged by black scaling proximally. Fringe uniformly metallic dark gray. **Hindwing:** Uniformly metallic black. Fringe metallic dark gray. **Abdomen:** Metallic black with a cream-white apical end. **Genitalia:** As in Fig. 74 (drawn from EME slide 3629, Jalisco, Mex.; n = 4). Tegumen dome-shaped, abruptly narrowed into a medial, distal process with a shallow depression at center. Socii short, horn-like, down-curved, approximately 0.45 X tegumen length. Saccus approximately 3.8 X tegumen length. Valva with enlarged, round distal end. Phallus slightly curved downward, distal end abruptly narrowed, approximately 1.35 X longer than tegumen + saccus. Aedeagus with several minute, hook-like external processes. Cornuti absent.

FEMALE. FW length 3.8-5.2 mm (4.61 ± 0.40 mm, n = 8). Color pattern as described for male. **Genitalia:** As in Fig. 122 (drawn from EME slide 3630, Minnesota; n = 2). Apophyses anteriores with posterior portion of ventral branches enlarged. Ventral bridge of apophyses anteriores rectangular. Ventral signum elongate, forming a short bar; dorsal signum oval, approximately 0.4 X as long as ventral signum.

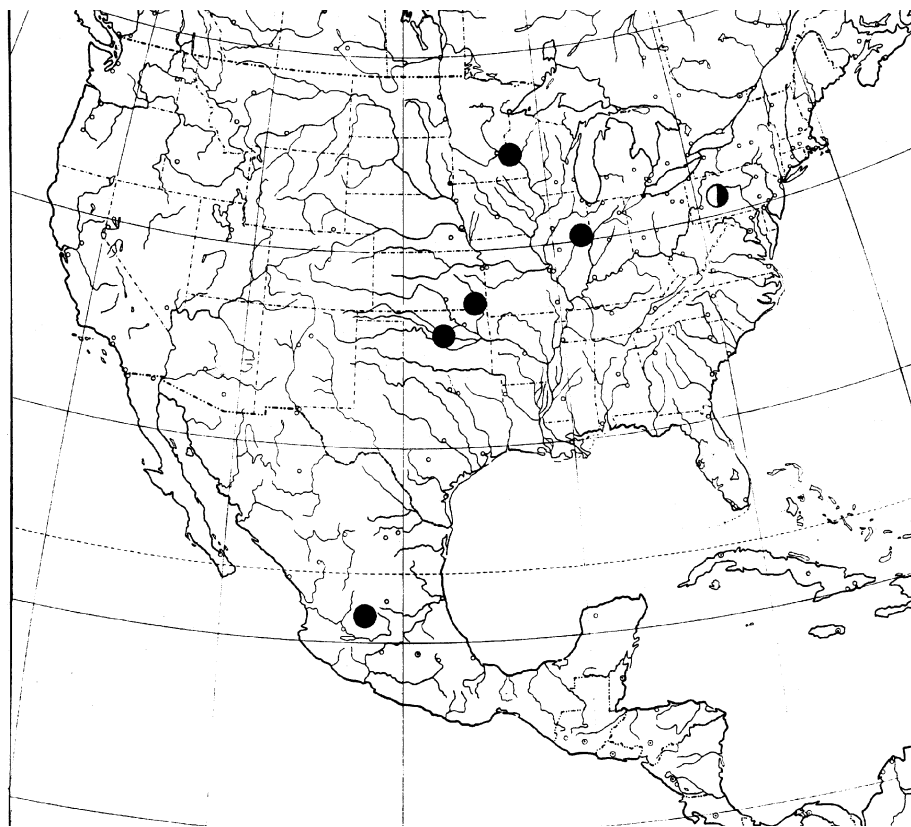

Fig. 12. Map of North America showing distribution records for *Embola ionis* (Clarke); half- open circle = PA state record.

TYPE MATERIAL: Holotype: ♂: **U.S.A.: ILLINOIS: CHAMPAIGN Co.:** Champaign, 5.VII.1951. (C. Wester, USNM no. 61496).

ADDITIONAL SPECIMENS EXAMINED: **MEXICO: JALISCO:** 1 ♂, San Juan Lagos. 27.VII.1951 (P. D. Hurd, UCB). **U.S.A.: ILLINOIS: CHAMPAIGN Co.:** 1 ♂, 1 ♀, Champaign, 5.VII.1951; 1 ♂, 2 ♀, 1.VIII.1951; 1 ♀, 25.VIII.1951 (C. Wester, USNM); 1 ♂, 20.VII.1951; 1 ♀, 25.XI.1951 (C. Wester, CAS) (Paratypes); 1 ♀, T19N, R9E, NE1/4, Sec14, 31.VII.1993, reared from *Mirabilis nyctaginea*; 1 ♂, T19N, R9E, Sec 13, III.1993, reared from *M. nyctaginea* (T. Harrison, UCB). **KANSAS: LABETTE Co.:** 1 ♀, Oswego. 3.IX.1965 (G. F. Hevel, USNM). **MINNESOTA: WABASHA Co.:** 1 ♀, Lake City. 12.VI.1970, at malaise trap (W. O. Powers, UCB). **MISSOURI: PIKE Co.:** 1 ♂, Louisiana, 30.V.1969 (W. S. Craig, MSU). **OKLAHOMA: OKLAHOMA Co.:** 1 ♀, Oklahoma City, 26.VIII.1955 (D. R. Davis, USNM). **PENNSYLVANIA:** (1 ex. abdomen missing)[no further data](W. G. Dietz, MCZ).

GEOGRAPHIC RANGE: (Fig. 12) U.S.A. (Illinois, Kansas, Minnesota, Missouri, Oklahoma, Pennsylvania); Mexico (Jalisco).

BIOLOGY: The biology of this species has been reported in detail by Wester (1956) and Harrison and Passoa (1995) in Illinois and is summarized as follows. The larval host is *Mirabilis nyctaginea* (Nyctaginaceae). The larva enters the stem at the base of an axial bud and tunnels downward. The frass is packed in the tunnels in the wake of the feeding larva. Overwintering occurs in the larval stage inside a silk-lined cavity in the stem, and pupation occurs in the stem. The overwintering generation has six instars, whereas the non overwintering generations have five. This species is estimated to have three generations per year (Wester 1956). The adult does not raise its hind legs in repose (Harrison, pers. com.).

Embola ciccella (Barnes and Busck), new combination
(Figs. 13, 75, 123, 161-162, 187)

Heliodines ciccella Barnes and Busck, 1920: 245; Heppner and Duckworth, 1983: 28 (checklist); Heppner, 1984: 57.

MALE. FW length 6.4-8.2 mm (7.45 ± 0.42 mm, $n = 30$). **Head:** Frons, vertex metallic black. Hood-like scale band posterior to vertex buff-yellow. Scaling behind eyes buff. Antenna metallic black with a small, metallic cream colored tip. Labial palpus buff yellow. **Thorax:** Metallic gray. Legs metallic gray on outer surfaces, buff on inner surfaces and around apical spurs of metatibia. Inner medial spur of metatibia approximately 2.7 X longer than outer. **Forewing:** Metallic spectrum orange with distal margin metallic gray tinged with green and purple. Maximum 6 costal and 3 dorsal, metallic gray spots tinged with green and purple and narrowly edged by black (number variable, sometimes different even between left and right wing of same individual; often fusion between spots). A medial, short metallic gray line between D2 and C4 spots in maximal spot number. A basal black bar along dorsum. Fringe uniformly brown, turning cream-white distally along costa. **Hindwing:** Uniformly metallic black. Fringe brown with buff base, turning cream-white along costa. **Abdomen:** Metallic dark brown with a cream-white terminal end. **Genitalia:** As in Fig. 75 (drawn from EME slides 3634 and aedeagus 3633, Ariz.; $n = 4$) and Figs. 161-162 (SEM). Tegumen tapering to a obtuse tip at distal half. Socii short, horn-like, slightly curved downward with an acute tip. Saccus approximately 3.5 X tegumen length. Valva narrowed at base, with obtuse distal end. Phallus slightly curved downward, approximately 1.3 X longer than tegumen + saccus. Aedeagus with two rows of hook-like external processes near distal end. Cornuti absent.

FEMALE. FW length 7.0-8.0 mm (7.67 ± 0.37 , $n = 19$). Color pattern as described for male. **Genitalia:** As in Fig. 123 (drawn from EME slide 3632, Ariz.; $n = 2$). Ventral bridge of apophyses anteriores nearly circular. Dorsal signum obovate; ventral signum orbicular, 0.5 X as long as dorsal signum.

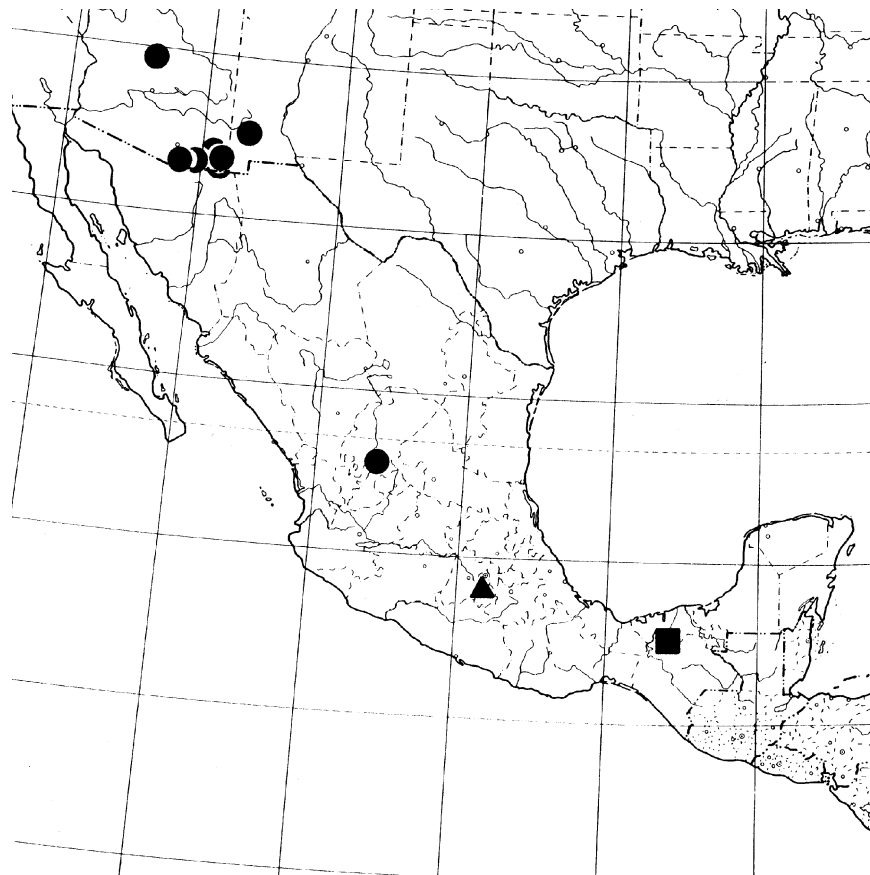

Fig. 13. Map of western North America showing distribution records for *Embola ciccella* (Barnes and Busck) [circles], *E. dentifer* Walsingham [triangle], and *E. xanthocephala* Walsingham [square].

TYPE MATERIAL: Holotype: ♂: U.S.A.: ARIZONA: Palmerlee [Miller Canyon, Huachuca Mountains., Cochise Co.] [no further data] (USNM no. 22675).

ADDITIONAL SPECIMENS EXAMINED: MEXICO: ZACATECAS: 1 ♀, 9 mi S Fresnillo, 20.VIII.1956 (D. D. Linsdale, UCB). U.S.A.: ARIZONA: 1 ♀, [no further data] (USNM) (Paratype); 1 ♀, [no further data] (O. C. Poling, USNM). COCHISE Co.: 3 ♂, 2 ♀, Palmerlee, [no further data] (USNM); 1 ♂, Paradise, [no further data] (USNM) (Paratypes); 1 ♂, Huachuca Mts., Carr Cyn., 9.VIII.1940 (E. S. Ross, CAS); 1 ♀, 30.VII.1986, black and white lights (D. L. Wagner, UCONN); 6 ♂,

Cave Cr., 1 mi SW Portal, 18.VII.1972, at black light (J. Powell, UCB, USNM); 1♂, 1♀, Cave Creek Cyn., Sunny Flat Campground, 5200', 2.VIII.1977 (J. P. & K.E. Donahue, LACM), 3♂, 1♀, 28.VII.1991, M. V. Lamp (M. & C. Prentice, UCB); 1♂, 3♀ Cave Creek Cyn., 4880', 20-28.VII.1967, 1♀, 21.VII.1967, 2♂, 3-4.VIII.1963 (J. G. Franclemont, USNM); 1♂, Chiricahua Mts., 4 mi W Portal, 5300', 3-6.VIII.1964 (D. R. Davis, USNM); 1♂, Chiricahua Mts, Pinery Cyn., 5400', 6.VIII.1991 (Powell, UCB); 1♀, Parker Dam Lake, 5800', 6.VIII.1979 (J. K. Liebherr, UCB). **PIMA Co.:** 1♀, Madera Cyn. at Bogg[s] Springs, 30-31.VII.1973, at black light (Powell, UCB). **SANTA CRUZ Co.:** Santa Rita Mts., Madera Cyn., 1♂, 27-30.VII.1947 (L. M. Martin, LACM); 1♀, 31.VII.1947 (J. A. Comstock, L. M. Martin, LACM); 10♂, 2♀, 4880', 21.VII to 3.VIII.1959 (R. W. Hodges, USNM); 1♂, 22.VII.1960 (J. G. Franclemont, USNM); 5♂, ca 5000', 23.VII.1971 (J. P. Donahue, L. M. Martin, A. Watson, LACM); 2♂, ♀, 5000', 8.VIII.1987 (R. Leuschner, LACM); **YAVAPAI Co.:** 1♀, Mingus Mt., 7600', 31.VII.1991 (Powell, Hsu, UCB). **NEW MEXICO: GRANT Co.:** 1♂, Bayard, 5800', 8.VIII.1980 (CDF, FSCA).

GEOGRAPHIC RANGE: (Fig. 13) U.S.A. (Arizona, New Mexico); Mexico (Zacatecas).

BIOLOGY: This is the largest and one of the most often collected Nearctic heliodinids, yet nothing is known of the larval biology. Nearly all collections have been made at lights.

Embola cyanozostera Hsu, new species
(Figs. 14, 44, 76, 124, 188)

MALE. FW length 5.5-5.8 mm (n = 2). **Head:** Frons, vertex metallic dark gray tinged with blue. Scaling behind eyes white. Antenna metallic black. Labial palpus cream-white with tip metallic gray tinged with blue. **Thorax:** Metallic dark gray tinged with blue. Legs metallic dark gray tinged with blue; spurs partially cream-white. Inner medial spur of metatibia approximately 2.3 X longer than outer. **Forewing:** Metallic spectrum orange with distal margin and basal area metallic dark gray tinged with blue. Two ends of distal margin enlarged, fused with transverse band. A broad transverse, metallic gray band tinged with blue at 1/3 from base. Bands, distal margin, and basal area all edged by black. Fringe uniformly dark brown. **Hindwing:** Uniformly black tinged with orange. Fringe dark brown, cream-white toward tornus. **Abdomen:** Metallic black tinged with indigo, scaling around terminal end white. **Genitalia:** As in Fig. 76 (drawn from EME slide 3639, Utah; n = 2). Tegumen elongate, cone-shaped with blunt distal end. Socii short, straight, with a blunt terminal tip, approximately 0.5 X tegumen length. Saccus approximately 3.3 X tegumen length. Valva broad, narrowed at base, with obtuse distal end. Phallus straight, approximately 1.15 X longer than tegumen + saccus. Aedeagus with a row of minute dorsal external processes subapically. Cornuti absent.

FEMALE. FW length 4.4-5.4 mm (5.00 ± 0.45 mm, $n = 6$). Color pattern as described for male but terminal scaling on abdomen black. Hindwing fringe uniformly dark brown. **Genitalia:** As in Fig. 124 (drawn from EME slide 3625, Nevada; $n = 3$). Ventral bridge of apophyses anteriores oval, enlarged distally. Dorsal signum an elongate shallow strip. Ventral signum oval, depressed, approximately 0.3 X as long as dorsal signum.

TYPE MATERIAL: Holotype: ♀: **U.S.A.: NEVADA: CLARK Co.:** Charleston Mountains, Kyle Canyon, 4700', 1.V.1993, associated with *Mirabilis multiflora* (Y.-F. Hsu, UCB).

2♂, 5♀ paratypes: **U.S.A.: NEVADA: CLARK Co.:** 1♀, Charleston Mts., Kyle Cyn., 26.IV.1950 (E. C. Johnston, CNC); 1♂, 4♀, 4700', 1.V.1993 (Hsu, UCB). **UTAH: WASHINGTON Co.:** 1♂, Virgin, 3900', 7.IV.1963 (L. R. O'Brien, UCB).

GEOGRAPHIC RANGE: (Fig. 14) U.S.A. (Nevada, Utah).

ETYMOLOGY: An adjective of Greek origin, from *kyanos* = dark blue, plus a noun of Greek origin, from *zoster* = belt.

BIOLOGY: Adults, including a mating pair, were collected from *Mirabilis multiflora* (Torrey) A. Gray (Nyctaginaceae) in Nevada, which suggests that this plant is the larval host of the species. The adult raises the hindlegs in repose.

Embola albaciliella (Busck), new combination
(Figs. 14, 77, 189)

Heliodines albaciliella Busck, 1910a: 182; Heppner and Duckworth, 1983: 28 (checklist); Heppner, 1984: 57 (checklist).

Heliodines albiciliella; Meyrick, 1913: 17 (name list), invalid emend., 1914b: 20.

MALE. FW length 5.7-6.0 mm ($n = 2$). **Head:** Frons, vertex metallic gray; hood-like scale band posterior to vertex white posteriorly. Scaling behind eyes pale buff. Antenna metallic gray. Labial palpus cream-white with metallic dark gray apical tip. **Thorax:** Metallic dark gray tinged with blue. Legs metallic dark gray with inner surfaces pale gray. **Forewing:** Metallic spectrum orange with metallic gray distal margin; 4 costal and 3 dorsal spots, silver tinged with bluish purple; C2 2.0 X larger than C1, C2, C4; dorsal spots size formula: $D3 > D2 > D1$. Fringe pale gray. **Hindwing:** Metallic pale gray. Fringe white. **Abdomen:** Metallic gray with cream-

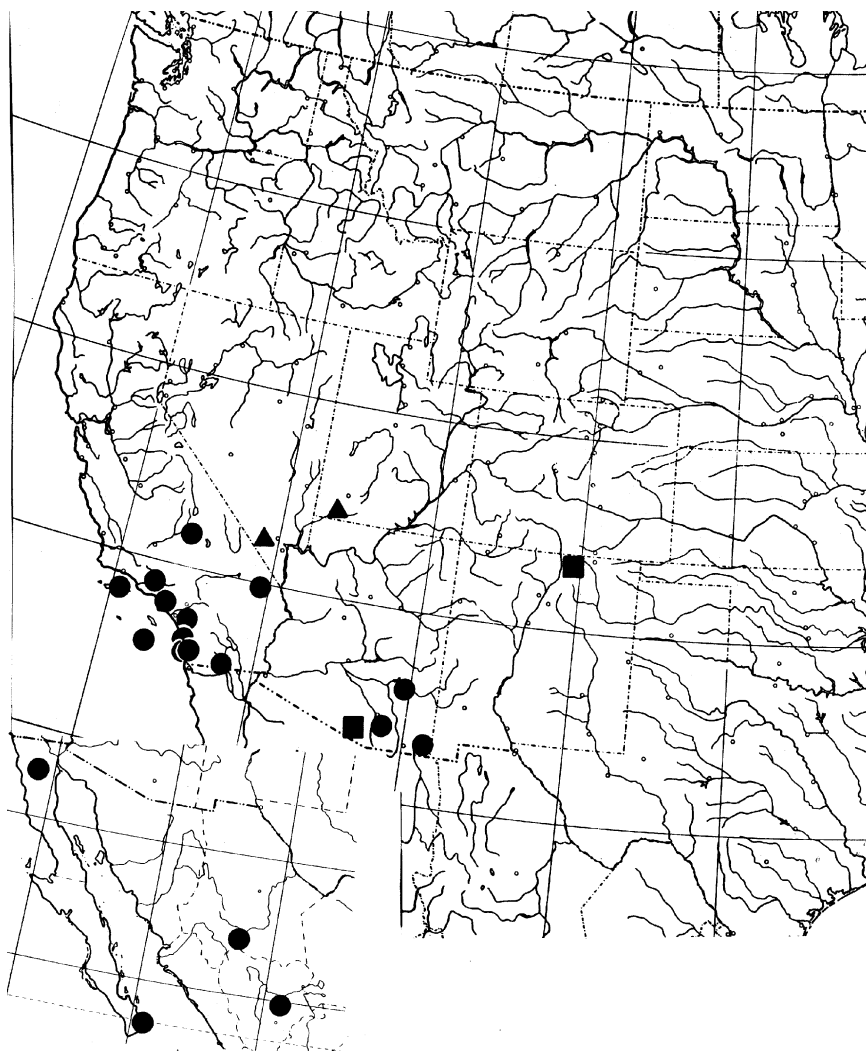

Fig. 14. Map of southwestern United States and northwestern Mexico (inset to lower left, slightly reduced) showing distribution records for *Embola powelli* Hsu [circles], *E. cyanozostera* Hsu [triangles], and *E. albiciliella* (Busck) [squares].

white terminal end. **Genitalia:** As in Fig. 77 (drawn from holotype; $n = 2$). Tegumen elongate with distal end blunt. Socii horn-like, slightly curved downward, terminal end acute, approximately 0.3 X tegumen length. Saccus approximately 3.1 X tegumen length. Valva broad, elliptic, distal end obtuse. Phallus curved downward, approximately 1.1 X tegumen + saccus. Cornuti forming series of small spines arranged longitudinally at distal end of aedeagus.

FEMALE. Unknown.

TYPE MATERIAL: Holotype: ♂: **U.S.A.: NEW MEXICO: COLFAX Co.:** Cimarron, "Sept" 1909. (deposited in USNM, No.12690, YFH slide 0970).

ADDITIONAL SPECIMEN EXAMINED: U.S.A.: ARIZONA: PIMA Co.: 1 ♂, Baboquivari Mts., 24.IV.1938 (J. A. Comstock, LACM).

GEOGRAPHIC RANGE: (Fig. 14) U.S.A. (Arizona, New Mexico).

Embola friedlanderi Hsu, new species
(Figs. 15, 78, 125, 190)

MALE. FW length 4.0-4.5 mm (4.27 ± 0.25 , $n = 3$). **Head:** Frons, vertex metallic pale gray; hood-like scales posterior to vertex black. Scaling behind eyes cream-white. Antenna metallic gray. Labial palpus cream-yellow with metallic dark gray apical tip. **Thorax:** Metallic gray. Legs metallic gray with metatibia and mesotibia black, distal end of procoxa cream-white. Spurs and areas adjacent to spurs pearly white. Inner medial spur of metatibia approximately 2.2 X longer than outer. Metatibia with prominent raised hairs dorsally. **Forewing:** Metallic orange yellow or spectrum orange with metallic gray outer margin; 5 costal and 3 dorsal metallic spots, edged by black, somewhat rectangular or square; spots size formula: $C3 > C2 > C4 > C5 > C1$, $D3 > D1 > D2$. Black along costa up to C3 and dorsal edge around base. Fringe metallic gray. **Hindwing:** Metallic very dark gray. Fringe metallic gray. **Abdomen:** Metallic very dark gray banded with metallic gray, cream-white ventrally and around distal end. **Genitalia:** As in Fig. 78 (drawn from EME slide 3642, San Luis Potosí, Mex.; $n = 2$). Socii reniform, curved upward, approximately 0.5 X tegumen length. Tegumen an elongate, cylindrical tube with posterior end slightly concave. Saccus approximately 4.25 X tegumen length. Valva elongate, curved upward, slightly convex ventrally, with distal end broadened, disk-like. Phallus straight, with pair of lateral, hook-like processes at distal end, approximately 1.25 X longer than tegumen + saccus. Cornuti absent.

FEMALE. FW length 5.0 mm ($n = 1$). Color pattern as described for male, but abdomen nearly uniformly metallic gray. **Genitalia:** As in Fig. 125 (drawn from EME slide 3641, San Luis Potosi, Mex.; $n = 1$). Ventral bridge of apophyses anteriores forming a narrow, transverse disk. Dorsal signum an elongate strip. Ventral signum oval, approximately 0.3 X as long as dorsal signum.

TYPE MATERIAL: Holotype: ♂: **MEXICO: SAN LUIS POTOSÍ:** 2 mi NE El Naranjo, 27.IX.1975, *Croton* sp. (J. Powell, J. Chemsak, T. Friedlander, UCB).



Fig. 15. Map of Mexico and Caribbean Antilles showing distribution records for *Embola autumnalis* Hsu [triangle], *E. friedlanderi* Hsu [circles], and *E. melanotela* Hsu [squares].

2♂, 1♀ paratypes: **MEXICO: CHIAPAS:** 1♂, 2 mi S. Tuxtla Gutierrez, El Zapotal, 10.VII.1957 (P. D. Hurd, UCB). **SAN LUIS POTOSÍ:** 1♂, 1♀, same data as holotype (UCB).

GEOGRAPHIC RANGE: (Fig. 15) Mexico (Chiapas, San Luis Potosí).

ETYMOLOGY: This species is named in honor of Dr. Timothy P. Friedlander, who has contributed to important phylogenetic research on Lepidoptera and participated in the expedition that produced the type series of this moth.

BIOLOGY: Adults were found on *Croton* (Euphorbiaceae), presumably a nectar source unrelated to the larval food plant.

Embola melanotela Hsu, new species
(Figs. 15, 80, 127, 191)

MALE. FW length 3.8 mm (n = 1). **Head:** Frons and vertex metallic dark gray. Scales behind eyes cream-white. Antenna metallic gray with distal end whitish. Labial palpus cream-white with distal 1/2 of 3rd segment gray. **Thorax:** Metallic gray. Legs metallic gray; distal ends of procoxa and mesocoxa white. Metafemur white. Areas adjacent to spurs including spurs white. Inner medial spur of metatibia

approximately 2.35 X longer than outer. **Forewing:** Metallic spectrum orange with broad outer margin of metallic gray tinged with purple; 5 costal and 3 dorsal, square, metallic gray spots tinged with green and edged with black; size formula: $C3 > C2 > C4 > C5 > C1$; $D1 > D3 > D2$. Two metallic gray streaks in outer margin, outer one longer than inner. Fringe metallic pale gray. **Hindwing:** Metallic pale gray. Fringe metallic pale gray. **Abdomen:** Metallic gray with buff distal end. **Genitalia:** As in Fig. 80 (drawn from YFH slide 1049, Haiti, USNM; n = 1). Tegumen an elongate cylindrical tube with posterior end depressed; a small bump in center of depression. Socii reniform, curved upward, with obtuse distal tip, approximately 0.4 X tegumen length. Saccus approximately 3.7 X tegumen length. Valva elongate, curved upward, distal end slightly enlarged. Phallus slightly curved downward with a pair of hook-like external processes near distal end, approximately 1.15 X longer than tegumen + saccus. Cornuti absent.

FEMALE. FW length 5.0-5.5 mm (n = 2). Color pattern as described for male but abdomen entirely metallic gray. **Genitalia:** As in Fig. 127 (drawn from YFH slide 1047, Puerto Rico, USNM; n = 2). Ventral bridge of apophyses anteriores square. Dorsal signum comparatively short, forming a very narrow strip; ventral signum oval, approximately 0.7 X as long as dorsal signum.

TYPE MATERIAL: Holotype: ♂: **HAITI:** Damien, 22.XI.1930, Acc. 30-307 (E. Ducasse, USNM).

2♀ paratypes: **PUERTO RICO:** 1♀, San Juan, Notuabo, 20.IV.1934, on *Lantana* sp. (Faxan, Mills, Anderson, USNM). **U.S. VIRGIN ISLANDS.:** 1♀, St. Thomas, 21-22.XII.1975 (D. Spillmaeckers, MSU).

GEOGRAPHIC RANGE: (Fig. 15) Haiti; Puerto Rico; U.S. Virgin Islands.

ETYMOLOGY: A adjective of Greek origin, from *melanos* = black, plus a noun of Greek origin, *telos* = end.

Embola autumnalis Hsu, new species
(Fig. 15, 81, 192)

MALE. FW length 5.5 mm (n = 1). **Head:** Frons and vertex metallic gray. Antenna metallic gray with white tip. Labial palpus cream-white with metallic gray distal tip. **Thorax:** Metallic gray. Legs metallic gray. Coxae with distal ends white. Metatibia metallic black, with upraised scales dorsally. Spurs, areas adjacent to spurs pearly white. Inner medial spur of metatibia approximately 2.4 X longer than outer. **Forewing:** Metallic spectrum orange with metallic gray outer margin; 5 costal and 3 dorsal metallic gray, rectangular spots with outer margins edged with black; size formula: $C3 > C2 > C4 > C5 > C1$; $D3 > D1 > D2$. Black at base, along costa to C2,

along dorsum around base. Fringe metallic gray. **Hindwing:** Metallic very dark gray. Fringe metallic gray, paler toward tornus. **Abdomen:** Metallic black banded with metallic gray, ventrally with cream-white along medial line. **Genitalia:** As in Fig. 81 (drawn from holotype; n = 1). Tegumen expanded distally to a cylindrical tube with distal end concave. Socii very short, approximately 0.4 X tegumen length. Saccus approximately 4.45 X tegumen length. Valva elongate, curved upward, slightly broadened at distal end. Phallus straight, approximately 1.15 X longer than tegumen + saccus.

FEMALE: Unknown.

TYPE MATERIAL: Holotype: ♂: **U.S.A.: ARIZONA: SANTA CRUZ Co.:** Santa Rita Mountains, Madera Canyon, 5600', 4.IX.1959 (R. W. Hodges, USNM).

GEOGRAPHIC RANGE: (Fig. 15) U.S.A. (Arizona).

REMARKS: This is probably the sister species of *E. friedlanderi* from eastern Mexico; *autumnalis* can be separated by its chrome orange forewing color and the medial process of the tegumen.

ETYMOLOGY: From Latin origin, *autumnus* = autumn, the season of abundance; so named because the single specimen was taken in September after Hodges had collected at Madera Canyon throughout the summer without finding this species.

Embola sexpunctella (Walsingham), new combination
(Figs. 82, 193)

Heliodines sexpunctella Walsingham, 1892b: 385; Dyar, 1903: 537; Busck, 1910a: 183; Meyrick, 1913: 17 (name list), 1914b: 20; Heppner and Duckworth, 1983: 28 (checklist); Heppner, 1984: 57 (checklist).

MALE. FW length 4.2 mm (n = 1). **Head:** Frons and vertex metallic pale gray. Antenna metallic pale gray with white tip. Labial palpus cream-white. **Thorax:** Metallic pale gray. Legs metallic pale gray. Procoxa metallic black leading to cream-yellow distal half. Metatibia and distal portion of mesotibia metallic black. Spurs and areas adjacent to spurs pearly white. Inner medial spur of metatibia approximately 2.0 X longer than outer. **Forewing:** Metallic spectrum orange, slightly paler around base, with metallic gray outer margin; 4 costal and 3 dorsal metallic gray spots with outer margins edged with black; size formula: C3 > C2 > C4 > C1, D3 > D1 > D2. Black along costa to C4 and along dorsum to D2. Fringe metallic gray. **Hindwing:** Metallic gray including fringe. **Abdomen:** Color recorded by Walsingham as "greyish fuscous." **Genitalia:** As in Fig. 82 (drawn from photo, Holotype, BMNH).

Terminal end of tegumen curved downward into a beak. Socii very short, with distal end far from reaching distal end of tegumen, horn-like, slightly curved downward, approximately 0.4 X tegumen length. Saccus approximately 2.5 X tegumen length. Valva elongate, straight at basal 1/3, strongly curved upward at distal 2/3. Phallus curved downward at posterior half, approximately 0.9 X longer than tegumen + saccus. Aedeagus with a row of minute external processes near distal end. Cornuti absent.

FEMALE. Unknown.

TYPE MATERIAL: Holotype: ♂: **U.S.A.: ARIZONA:** "1883 " [no further data] (Morrison, BMNH, slide 9378).

GEOGRAPHIC RANGE: U.S.A. (Arizona).

Embola dentifer Walsingham
(Figs. 13, 83, 194)

Embola dentifer Walsingham, 1909: 42.

Lamprolophus dentifera Meyrick, 1913: 13 (name list), invalid emend., 1914b: 19; Heppner, 1984: 57 (checklist).

MALE. FW length 6.2 mm (n = 1). **Head:** Frons and vertex metallic gray; hood-like scales posterior to vertex orange. Antenna metallic gray with base slightly yellow. Labial palpus metallic gray with dark distal end. **Thorax:** Metallic gray tinged with purple. Legs metallic gray tinged with purple. Coxae with cream-yellow distal end. Mesotibia metallic black with area adjacent to spurs cream-yellow; additional cream-yellow spot immediately preceding spurs. Metatibia metallic black, with areas adjacent to spurs metallic gray. Spurs pearly white. Inner medial spur of metatibia approximately 1.9 X longer than outer. **Forewing:** Metallic spectrum orange with metallic black distal margin; 4 costal and 3 dorsal metallic gray spots tinged with green; size formula: C3 > C4 > C2 > C1, D3 > D1 > D2. Two metallic gray bars tinged with green within black distal margin; one along costa, one along dorsum. Markings edged by black and extensive black along entire costa and along dorsum to D1. Fringe metallic gray. **Hindwing:** Metallic dark brown. Fringe metallic gray. **Abdomen:** Colors recorded by Walsingham as "brownish fuscous, anal tuft ochreous." **Genitalia:** As in Fig. 83 (drawn from photo, holotype, slide 9372, BMNH). Tegumen tapering to obtuse distal end. Socii elongate, robust, with distal end not beyond distal end of tegumen, horn-like, strongly curved downward, with blunt terminal end, approximately 0.4 X tegumen length. Saccus approximately 3.4 X tegumen length. Valva comparatively short, broad, strongly curved upward with rounded terminal end. Phallus narrowed at distal 1/3, approximately 1.15 X longer than tegumen + saccus, slightly curved upward toward distal end. Vesica with rows

of small bumps (cornuti) at distal end of aedeagus.

FEMALE. Unknown.

TYPE MATERIAL: Holotype: ♂: **MEXICO: MORELOS:** Cuernavaca, "VI.18," Gdm. Slvn. 66004 (H. H. Smith, BMNH, slide 9372).

GEOGRAPHIC RANGE: (Fig. 13) Mexico (Morelos).

Embola powelli Hsu

(Figs. 14, 84, 128, 167, 170, 195)

Embola powelli Hsu, 2002: 134.

MALE. FW length 2.8-5.4 mm (3.58 ± 0.49 , $n = 21$). **Head:** Frons and vertex metallic gray tinged with blue. Scaling behind eyes cream-white. Antenna metallic dark gray. Labial palpus metallic gray with basal segment cream-white. **Thorax:** Metallic dark gray tinged with blue. Legs metallic gray tinged with blue. Prefemur and mesotibia with distal ends cream-white. Metatibia with a whorl of white scales adjacent to spurs; black preceding the white whorl. Inner medial spur of metatibia approximately 2.2 X longer than outer. **Forewing:** Metallic chrome or flame orange with distal margin metallic gray tinged with blue; 3 costal and 1 dorsal metallic gray spots tinged with blue; size formula: C1, C3, and C4 subequal, C2 extended to join D1; a transverse band of same color at 1/3 from base; C1 proximal, C2 and C3 distal to transverse band. Markings edged with black and extensive black along costa, in some specimens also along dorsal margin. Fringe gray tinged with orange. **Hindwing:** Metallic pale gray tinged with blue. Fringe gray tinged with orange, cream-white toward tornus. **Abdomen:** Metallic black, banded with silver, cream-yellow at terminal end. **Genitalia:** As in Fig. 84 (drawn from EME slide 3646, Riverside Co., Calif.; $n = 8$). Tegumen cone-shaped, attenuate to curved upward, blunt distally. Socii elongate, dilated at base, rod-like with a blunt, curved downward distally, approximately 0.65 X tegumen length. Saccus approximately 3.15 X tegumen length. Valva broad, elongate with basal portion narrowed. Aedeagus very narrow, slightly curved downward distally, approximately 1.2 X longer than tegumen + saccus. Vesica with a cluster of rugose cornuti at distal end of aedeagus.

FEMALE. FW length 2.8-4.8 mm ($3.55 + 0.59$ mm, $n = 17$). Color pattern as described for male but lacking cream-yellow terminal scaling on abdomen. **Genitalia:** As in Fig. 128 (drawn from YFH slide 1044, Ariz., CNC; $n = 7$). Ventral bridge of apophyses anteriores oval or somewhat rectangular. Ventral signum elongate, irregularly bordered, forming a deeply invaginated band; dorsal signum oval or an elongate, slightly depressed band, length variable, ranging from 1/2 to nearly as long as ventral signum.

TYPE MATERIAL: Holotype: ♂: **U.S.A.: CALIFORNIA: SAN DIEGO Co.:** 2 mi NE of Lakeside, 400', 16.III.1994, reared from *Mirabilis californica*, emerged 18.IV.1994, JAP 94C54 (Y.-F. Hsu, H. H. Chuah, UCB).

ADDITIONAL SPECIMENS EXAMINED: 21♂, 20♀ Paratypes: **MEXICO: BAJA CALIFORNIA NORTE:** 1♀, 4 mi SW La Zapopita, Valle de Trinidad, 16.IV.1961 (F. S. Truxal, LACM). **BAJA CALIFORNIA SUR:** 1♀, 30 km E La Ribera, Rancho Las Barracas, 21-24.III.1982 (M. Irwin, E. Schlinger, UCB). **CHIHUAHUA:** 1♀, 12 mi W Hidalgo del Parral, 6200', 14.VII.1964 (Powell, UCB); **DURANGO:** 1♂, 26 mi S La Zarca, 16.VII.1964, on *Encelia* (J. A. Chemsak, UCB). **U.S.A.: ARIZONA: COCHISE Co.:** 1♀, 3 mi NW Chiricahua, 5.VIII.1991 (Hsu, Powell, UCB). **GRAHAM Co.:** 1♀, Aravaipa Cyn., Wild Turkey Cr., MVL, 26.VII.1989 (B. & J.-F. Landry, CNC). **PIMA Co.:** 1♂, T19S, R16E, S18, 10.X.1960 (R. W. Hodges, USNM). **CALIFORNIA: IMPERIAL Co.:** 1♂, 2 mi E Mountain Springs, 28.IV.1993, reared from *Mirabilis tenuiloba*, emgd. 18.V.1993, JAP 93D41.1, 1♂, 18.III.1994, reared from *M. tenuiloba*, emgd. 12.IV.1994, JAP 94C62 (Hsu, Chuah, UCB); 2♂, same locality, 20.VII.1994, reared from *M. tenuiloba*, emgd. 25.VIII.1994, JAP 94G25 (Hsu, UCB). **KERN Co.:** 1♂, 4 mi N Red Rock Cyn., 3.V.1968, on *Haplopappus cooperi* (Powell, UCB). **LOS ANGELES Co.:** 1♀, Whittier, 12.XII.1910, on flowers of *Encelia californica* (P. H. Timberlake, USNM); 2♂, 3♀, San Clemente I., Seal Cove, Rock Wall Cyn. area, 14.IV.1980, associated with *Mirabilis laevis* [= *californica*] (Powell and D. K. Faulkner, SDNHM, UCB); 1♀, San Clemente I., West Cove, associated with *M. laevis* [= *californica*], 15.IV.1980 (Powell, Faulkner, UCB). **RIVERSIDE Co.:** 1♂, 4 mi E Elsinore, R[ail] R[oad] Cyn., 17.IV.1965 (Powell, UCB). **SAN BERNARDINO Co.:** 1♂, 7 mi SE Kelso, Vulcan Mine Rd., 26.IV.1977 (Powell, UCB). **SAN DIEGO Co.:** 4♂, 1♀, 1 mi E Cardiff, 24-31.III.1974 (Powell, SDNHM, UCB); 1♀, La Jolla, 18.VI.1963; 1♂, 2 mi NE Lakeside, 400', 30.III.1961, 1♂, 13.III.1963, 1♂, 1♀, 24-25.III.1993 (all Powell, UCB); 1♀, same locality, 27.IV.1993, reared from *M. californica*, emgd. 11.VI.1993, JAP 93D39 (Hsu, UCB); 1♀, same data as holotype, 16.III.1994, reared from *M. californica*, emgd. 17.IV.1994, JAP 94C54 (Hsu, Chuah, UCB). **SANTA BARBARA Co.:** 1♀, Santa Cruz I., Lower Central Valley, 24.V.1984 (J. F. Landry, CNC). **VENTURA Co.:** 1♂, 1♀, Santa Susana Mts., Tapo Cyn., 16-19.IV.1939, on *M. californica* (L. M. Martin, LACM).

GEOGRAPHIC RANGE: (Fig. 14) U.S.A. (California, Arizona); Mexico (Estado Baja California, Baja California Sur, Chihuahua, Durango).

BIOLOGY: Larval hosts are *Mirabilis californica* (JAP 93D39, 94C54) and *M. tenuiloba* (JAP 93D41.1, 94C62) (Nyctaginaceae) in southern California. The larva enters by boring a hole at any position on the stem; frass is deposited in the larval gallery. Pupation occurs in the stem, and the adult emerges through a hole made by the larva. Adults of both sexes have been observed at flowers of Asteraceae (*Encelia*,

Haplopappus), presumably nectar sources. The adult raises the hind legs in repose.

Embola xanthocephala Walsingham
(Figs. 13, 85, 196)

Embola xanthocephala Walsingham, 1909: 3.

Lamprolophus xanthocephala; Meyrick, 1913: 13 (name list), 1914b: 19;

Heppner, 1984: 57 (checklist).

MALE. FW length 4.3-4.4 mm (n = 2). **Head:** Frons and vertex metallic gray. Hood-like scale band posterior to vertex orange-yellow. Antenna metallic gray with base orange ventrally. Labial palpus buff-yellow with metallic gray distal tips. **Thorax:** Metallic gray tinged with purple. Legs metallic gray. Distal ends of coxae cream-orange. Mesotibia metallic black with three pearly white bands. Metatibia metallic black with areas adjacent to spurs pearly white. Inner medial spur of metatibia approximately 2.3 X longer than outer. **Forewing:** Metallic chrome orange with black

outer margin; 5 costal and 3 dorsal, somewhat rectangular spots, metallic gray tinged with purple, edged by black; size formula: C3 > C4 > C2, C5 > C1; D3 > D1 > D2. Extensive black along costa to C4, along dorsum to D2. Two parallel, subapical bands metallic gray tinged with purple, outer one longer than inner. Fringe metallic gray. **Hindwing:** Metallic gray. Fringe metallic gray. **Abdomen:** Not available. **Genitalia:** As in Fig. 85 (drawn from photo, holotype, slide 9373, BMNH). Tegumen tapered to a blunt distal end. Socii extremely short, laterally flattened bumps with acute ends, approximately 0.35 X tegumen length. Saccus approximately 2.85 X tegumen length. Valva slender, strongly up-curved, with slightly enlarged, round distal end. Aedeagus with apical external processes laterally, approximately 1.15 X longer than tegumen + saccus.

FEMALE. Unknown.

TYPE MATERIAL: Holotype: ♂: **MEXICO: TABASCO:** Teapa, "III.18" [no further data], Gdm. Slv. 66001 (H. H. Smith, BMNH, slide 9373). Paratype: **MEXICO: TABASCO:** 1 ex. [abdomen missing], same data.

GEOGRAPHIC RANGE: (Fig. 13) Mexico (Tabasco).

Embola species

Among the heliodinid species Hsu (1995) listed as new was an *Embola* species from "Florida." The only known specimen is from the Meyrick collection (BMNH) and bears the label "Florida, R.06." The locality almost certainly is Florida, São

Paulo, Brazil, rather than the state of Florida, U.S.A. Another case involving the same label and its resultant confusion was reported for *Chrysoxena auriferana* (Busck) (Tortricidae) (Brown and Powell 1991: 22). Therefore, the species treated by Hsu (1995) is outside the geographical scope of this study and is not named here. To avoid potential confusion, we call attention to it here and characterize the species as follows.

MALE. FW 4.0 mm (n = 1). **Head:** Frons, vertex, antenna metallic gray. [Labial palpi missing from the unique type.] **Thorax:** Metallic gray. Legs metallic dark gray. Spurs and areas adjacent to spurs cream-yellow. Inner medial spur of metatibia 2.3 X longer than outer. **Forewing:** Metallic spectrum orange with narrow metallic black outer margin; 4 costal and 3 dorsal metallic gray spots; size formula: $C3 > C4 > C2 > C1$, $D1 > D3 > D2$. Black along costa to $C4$, along dorsum to $D1$. Fringe metallic gray. **Hindwing:** Metallic dark gray. Fringe metallic gray. **Abdomen:** Metallic dark gray with yellow along medial line ventrally; distal end yellow. **Genitalia:** (photo, slide 27931, BMNH). Socii short, straight, cone-like, approximately 0.3 X tegumen length. Saccus curved downward at distal end, approximately 2.9 X tegumen length. Valva strongly curved upward, narrow at base, enlarged distally, ending with obtuse distal end. Phallus approximately 1.05 X longer than tegumen + saccus.

SPECIMEN EXAMINED: ♂: Florida [19]06 [no further data][Brazil](Meyrick, BMNH, slide 27931).

HELIOGEMMA Hsu, new genus
(Figs. 16, 33, 86, 129-131, 87-89)

Type species: *Heliogemma gigantea* Hsu, new species. Gender feminine. From Greek, *helio* = sun, and Latin, *gemma* = jewel.

Other included species: *H. grandis* Hsu, new species; *H. preclara* Hsu, new species.

DIAGNOSIS: Large (FW length 5.0-7.5 mm). Antenna flattened. Coecum penis very long, coiled distally. Appendix bursae present. Ductus bursae extremely slender.

Head: Scales behind eyes long, linear. Antenna laterally flattened, longer than FW length. **Thorax:** Inner medial spur of metatibia 1.5-2.0 X longer than outer. Metatibia with lateral and ventral scale tufts around spurs. Spurs with spiniform hairs along posterior edge. **Forewing:** (Fig. 33) 10 veins, all separate except $CuA1$ forked near end of cell. Ground color dark with brightly colored basal patch. **Hindwing:** 6 veins, all separate except Cu veins. Frenulum of female a single bristle. **Abdomen:** $A8$ of male with tergum and pleura fused; tergum well developed, triangular; pleura

weakly sclerotized, nearly semicircular. Coremata in male forming a pair of pouches containing elongate, slender, linear scales. **Male genitalia** (Fig. 86): Tegumen stout, with distal end strongly concave. Socii widely separated, convergent distally. Saccus slender, much longer than tegumen, posterior end a swollen club. Phallus elongate, narrow, with minute external processes around distal end; bulbus ejaculatorius extremely long, coiled. Cornuti absent. **Female genitalia** (Figs. 129-131): Ventral bridge of apophyses anteriores broad with boundary poorly defined. Apophyses anteriores shorter than posteriores. Apophyses posteriores with caudal end forming flat, elongate, blade-like sclerotized band. Ductus bursae much longer than corpus bursae, with ductus seminalis opening on ductus bursae near corpus bursae. Minute teeth on inner wall near ostium. Ostium bursae unmodified. Signum forming shallow, broad depression near base of corpus bursae.

Larval hosts unknown.

KEY TO SPECIES OF *Heliogemma*

1. Base of FW orange; HW with orange scaling and fringe partially orange
 *preclara*
 Base of FW scarlet; HW entirely gray including fringe 2
2. Labial palpus cream-yellow; abdominal scaling gray except A1 dorsum orange
 *gigantea*
 Labial palpus dark brown; abdominal scaling scarlet dorsally *grandis*

Heliogemma gigantea Hsu, new species (Figs. 16, 33, 86, 129, 198)

MALE. FW length 5.5 mm (n = 1). **Head:** Frons and vertex metallic gray tinged with turquoise green. Scaling behind eyes dark brown, a few scales buff at ends. Antenna metallic dark gray tinged with turquoise green. Labial palpus cream-yellow with dark brown apical tip. **Thorax:** Metallic dark gray tinged with turquoise green. Legs of same color with distal end of metacoxa buff. Inner medial spur of metatibia approximately 2.0 X longer than outer. **Forewing:** Ground color metallic dark gray tinged with turquoise green; basal 1/4 scarlet. A small metallic dark gray costal patch at base. Fringe metallic dark gray. **Hindwing:** Metallic dark gray tinged with orange. An elongate cream colored patch along costa at basal half. Fringe metallic gray. **Abdomen:** Metallic pale black with A1 orange dorsally; terminal end pale buff. **Genitalia:** As in Fig. 86 (drawn from Holotype; n = 1). Socii short, digitate, approximately 0.3 X tegumen length. Saccus approximately 3.2 X tegumen length. Valva slender, elongate, slightly convex ventrally, with a blunt distal end. Phallus elongate, slightly curved downward and abruptly narrowed distally, with two pairs of minute external processes dorsoventrally near distal end. Phallus approximately 1.5 X longer than tegumen + saccus. Bulbus ejaculatorius nearly straight anteriorly.

Coecum penis very long, double-coiled dorsally.

FEMALE. FW length 7.1-7.6 mm (7.28 ± 0.12 mm; $n = 3$). Color pattern as in male, scaling behind eyes cream-white toward ventral end. Abdomen entirely metallic very dark gray with no orange on A1. **Genitalia:** As in Fig. 129 (drawn from EME slide 3589, Jalisco, Mex.; $n = 2$). Ventral bridge of apophyses anteriores somewhat rectangular. Minute teeth at base of ductus bursae forming elongate band, more condensed distally. Signum somewhat heart-shaped.

TYPE MATERIAL: Holotype: ♂: **MEXICO: JALISCO:** Est[ación]. Biol[ogía]. Chamela, 12-15.VII.1987 (J. A. Chemsak, E. G. and J. M. Linsley, UCB) [EME slide 3589].

3♀ paratypes: 2♀, **MEXICO: JALISCO:** Est. Biol. Chamela, 8-16.VII.1985 (J. Chemsak, H. Katsura, A. & M. Michelbacher, UCB); **MORELOS:** 1♀, 13 mi S Cuernavaca, 8.VII.1962 (D. H. Janzen, UCB).

GEOGRAPHIC RANGE: (Fig. 16) Mexico (Jalisco, Morelos).

ETYMOLOGY: An adjective of Latin origin, *gigantis* = giant.

Heliogemma grandis Hsu, new species
(Figs. 16, 130, 199)

FEMALE. FW length 6.0-6.6 mm ($n = 2$). **Head:** Frons and vertex metallic gray tinged with turquoise green. Scaling behind eyes dark brown. Antenna metallic dark gray tinged with turquoise green. Labial palpus dark brown. **Thorax:** Metallic dark gray tinged with turquoise green. Legs of same color. Inner medial spur of metatibia approximately 1.6 X longer than outer. **Forewing:** Ground color metallic dark gray tinged with turquoise green; basal 1/5 scarlet. A small metallic dark gray costal patch at base. Fringe metallic dark gray. **Hindwing:** Metallic dark gray tinged with orange; basal 1/2 with elongate cream colored patch along costa. Fringe metallic gray. **Abdomen:** Metallic scarlet, distal end metallic black tinged with turquoise green; black more extensive ventrally. **Genitalia:** As in Fig. 130 (drawn from Holotype; $n = 2$). Ventral bridge of apophyses anteriores somewhat triangular. Minute teeth at base of ductus bursae forming somewhat triangular concentration. Signum reniform.

MALE. Unknown.

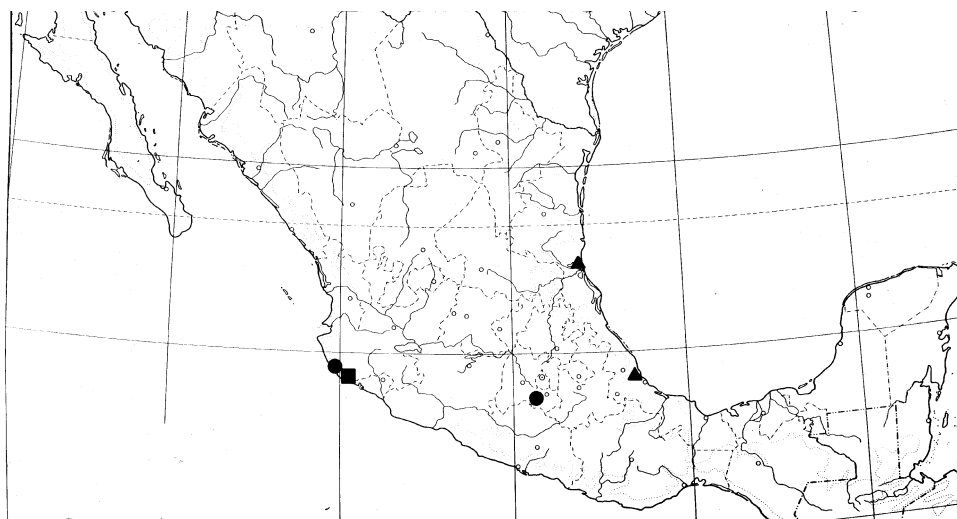

Fig. 16. Map of Mexico showing distribution records for *Heliogemma gigantea* Hsu [circles], *H. grandis* Hsu [triangles], and *H. preclara* Hsu [square].

TYPE MATERIAL: Holotype: ♀: **MEXICO: TAMAULIPAS:** Playa Altamira, 5.VII.1968 (M. S. Wasbauer and J. E. Slansky, UCB) [EME slide 3656].

1 ♀, paratype: **MEXICO: VERACRUZ:** 16.2 mi N Puente Nacional, 21.VI.1962 (D. H. Janzen, UCB).

GEOGRAPHIC RANGE: (Fig. 16) Mexico (Tamaulipas, Veracruz).

ETYMOLOGY: An adjective of Latin origin, *grandis* = large.

REMARKS: This species is most closely related to *P. gigantea* but can be separated readily by its metallic scarlet abdomen and less extensive minute teeth basally on the ductus bursae.

Heliogemma preclara Hsu, new species
(Figs. 16, 131, 200)

FEMALE. FW length 5.0 mm (n = 1). **Head:** Frons and vertex metallic gray tinged with turquoise green. Scaling behind eyes pale brown, cream-yellow toward ventral end. Antenna metallic dark gray. Labial palpus pearly white with distal tip slightly buff. **Thorax:** Metallic gray tinged with turquoise green; pleura extensively

covered by metallic chrome orange and cream-yellow. Legs metallic gray tinged with turquoise green. Distal ends of procoxa, mesocoxa cream-yellow; metacoxa with cream-yellow, chrome orange. Mesotibia, metafemur, anterior 2/3 of metatibia extensively covered by metallic chrome orange. A metallic black patch tinged with reddish purple at distal end of metatibia. Inner medial spur of metatibia approximately 1.55 X longer than outer. **Forewing:** Metallic dark gray with basal 1/4 metallic chrome orange. A small, metallic, dark gray costal spot near base. Fringe pale gray. **Hindwing:** Metallic spectrum orange with distal 1/4 metallic dark gray. Fringe metallic spectrum orange in proximal 3/4, metallic pale gray in distal 1/4. **Abdomen:** Metallic chrome orange tinged with purplish pink; distal end metallic black ventrally and cream-yellow dorsally. **Genitalia:** As in Fig. 131 (drawn from Holotype; n = 1). Ventral bridge of apophyses anteriores very broad, rectangular, with boundary better defined than in *H. gigantea* and *H. grandis*. Minute teeth at base of ductus bursae forming elongate band, sparsely arranged for distal 2/3, abruptly leading to high concentration for anterior 1/3. Signum nearly obicular in shape.

MALE. Unknown.

TYPE MATERIAL: Holotype:♀: **MEXICO: JALISCO:** 4 km S Playa Careyes, 9-11.VII.1987 (J. A. Chemsak, E. G. & J. M. Linsley, UCB).

GEOGRAPHIC RANGE: (Fig. 16) Mexico (Jalisco).

ETYMOLOGY: An adjective of Latin origin, *preclarus* = very beautiful, splendid.

PSEUDASTASIA Walsingham
(Figs. 34, 87, 197)

Pseudastasia Walsingham, 1909: 1.

Type species: *Pseudastasia opulenta* Walsingham, 1909: 2; by monotypy. Gender feminine.

DIAGNOSIS: Cu₂ vein absent in FW, present in HW. Frenulum consisting of 2 equally long bristles. Ostium bursae surrounded by a sclerotized ring. Signa double, strongly dentate.

Male genitalia as in Fig. 87 (drawn from photo, slide 27935, BMNH; n = 1).

Literature reference: Walsingham 1909: 1 (Panama). Monobasic.

EUHELIODINES Hsu, new genus
(Figs. 17, 35, 88-89, 132, 158, 201-202)

Type species: *Euheliodines chemsaki* Hsu, new species. Gender masculine. From Greek, *eu* = good, true, plus *Helioidines*.

Other included species: *E. jaliscella* Hsu, new species.

DIAGNOSIS: Cu2 vein present in FW, absent in HW. Frenulum consisting of 2 equally long bristles. Ostium bursae surrounded by a sclerotized ring. Signa double, heavily dentate.

Head: Scales behind eyes long, slender. Antenna approximately 0.8 X FW length. **Thorax:** Medial spurs of metatibia 1.5-2.0 X longer than outer. Metatibia without ventral and terminal bristle-like scales around spurs and tarsi without apical bristle-like scales (Fig. 158). Scaling uniformly colored. **Forewing:** (Fig. 35) 11 veins, R1 and R2 forked with Rs; other R veins all separate. Retinaculum of female a series of arched hairs. Ground color orange with a metallic gray margin and a transverse band. **Hindwing:** 5 veins, all separate. Frenulum consisting of two bristles of equal length. **Abdomen:** A8 of male weakly sclerotized with elongate tergum. Pleura and sternum largely membranous with posterior end of pleura forming weakly sclerotized, paired, oval lobes. Coremata in male forming a pair of shallow slits on a membrane, each with a bundle of bristle-like scales. **Male genitalia** (Figs. 88, 89): Tegumen truncate; 10th tergite forming a transverse, narrow sclerite that bridges the thickened socii. Valva simple, slender, sparsely setose. Aedeagus attenuate posteriorly into blunt distal end. Bulbus ejaculatorius joining phallobase subterminally. **Female genitalia** (Fig. 132): Sternite A8 broadly sclerotized with ventral branches originating from a broad, sclerotized area. Ductus seminalis opening at ductus bursae. Ostium bursae surrounded by a sclerotized ring. Signa double, strongly dentate; one located immediately anterior to junction with ductus bursae, the other on opposite wall.

Larval hosts unknown.

KEY TO SPECIES OF *Euheliodines*

- FW markings restricted to a transverse metallic gray band. Caudal end of tegumen truncate *chemsaki*
FW with metallic gray spots. Caudal end of tegumen protruding
..... *jaliscella*

Euheliodines chemsaki Hsu, new species

(Figs. 17, 35, 88, 132, 158, 201)

MALE. FW length 3.7-4.2 mm (3.94 ± 0.24 mm, n = 5). **Head:** Frons and vertex metallic gray. Scaling behind eyes white. Antenna metallic black. Labial palpus buff with metallic dark gray distal tip. **Thorax:** Metallic gray. Legs metallic gray. Inner

medial spur of metatibia approximately 1.7 X longer than outer. **Forewing:** Metallic chrome orange with metallic gray distal margin and transverse, metallic gray medial band; distal margin and band edged by black; black around base and extending along costa and dorsum between outer margin and transverse band. Fringe uniformly metallic gray. **Hindwing:** Metallic dark gray. Fringe uniformly metallic gray. **Abdomen:** Metallic dark gray dorsally and gray ventrally. **Genitalia:** As in Fig. 88 (drawn from EME slides 3658, 3659 socii, 3657 aedeagus, Baja Calif., Mex.; n = 4). Socii approximately 0.55 X tegumen length. Saccus approximately 2.3 X longer than tegumen. Valva flattened, elongate with basal half slightly enlarged, with blunt, obtuse distal tip. Phallus approximately 3.9 X longer than tegumen + saccus; aedeagus attenuate distally, curved downward with sharp distal tip. Cornuti a pair of small flat sclerites each with an inner tooth.

FEMALE. FW length 3.4-4.2 mm (3.85 ± 0.35 mm, n = 6). Color pattern as described for male. **Genitalia:** As in Fig. 132 (drawn from EME slide 3660, Baja Calif., Mex.; n = 3)). Ventral bridge of apophyses anteriores enormously broadened, covering large area distal to ventral branches of apophyses anteriores. Anterior end of apophyses posteriores enlarged, flattened, club-like. Sclerotized ring around ostium bursae elongate, cylindrical.

TYPE MATERIAL: Holotype: ♂: **MEXICO: SAN LUIS POTOSÍ:** 6 mi E Matehuala, 5300', "21.X.1976" [label error] = 21 September 1976, on *Parthenium hysterophorus* (J. A. Powell & J. A. Chemsak, UCB).

4♂, 6♀ paratypes: **MEXICO: SAN LUIS POTOSÍ:** 1♀, same data as holotype.

BAJA CALIFORNIA SUR: 1♂, 2♀, 12 mi NW La Paz, 18.IX.1967 (J. A. Chemsak, A. E. Michelbacher, UCB); 3♂, 26 mi NW La Paz, 18.IX.1967 (Chemsak, Michelbacher, UCB); 1♀, 12.8 mi SSE Santa Rosalia, 23.IX.1981 (D. Faulkner, F. Andrews, SDNHM). U.S.A.: **ARIZONA: PIMA Co.,** 1♀, Santa Catalina Mts., Bear Cyn., 31.VII.1972 (Powell, UCB). **NEW MEXICO: HIDALGO Co.:** 1♀, Rodeo, 23.VIII.1958 (M. A. Cazier, UCB).

GEOGRAPHIC RANGE: (Fig. 17) U.S.A. (Arizona, New Mexico); Mexico (Baja California Sur, San Luis Potosí).

ETYMOLOGY: This species is named in honor of Dr. John A. Chemsak, a coleopterist who has made diverse collections of tropical American microlepidoptera, including many heliodinids.

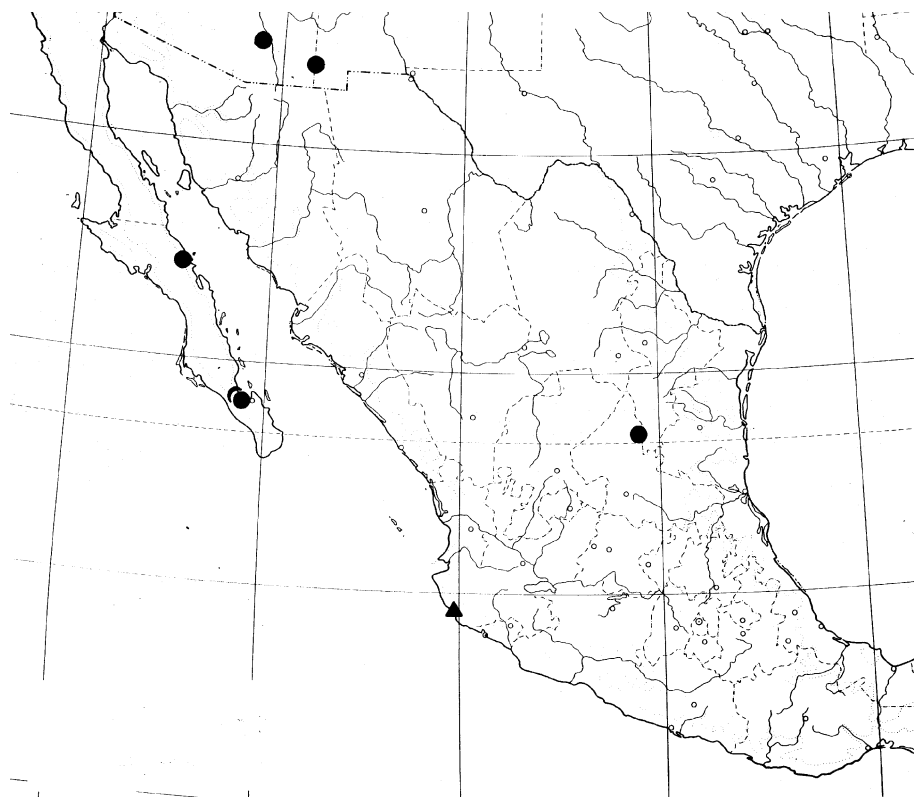

Fig. 17. Map of southwestern United States and Mexico showing distribution records for *Euheliodines chemsaki* Hsu [circles] and *E. jaliscella* Hsu [triangle].

BIOLOGY: Adults were taken during late afternoon at flowers of *Parthenium hysterophorus*, a weedy Asteraceae, along with specimens of *Neoheliodines melanobasilaris* Hsu, described above. Nonetheless, *Parthenium* probably was a nectar source and not the larval food plant.

Euheliodines jaliscella Hsu, new species
(Fig. 17, 89, 202)

MALE. FW length 3.6 mm (n = 1). **Head:** Frons and vertex metallic gray. Hood-like scale band posterior to vertex buff-yellow. Scaling behind eyes buff. Antenna metallic gray with cream-white base. Labial palpus cream-yellow. **Thorax:** Metallic gray. Legs metallic gray. Distal ends of coxae orange-yellow. Mesotibia with two cream-yellow bands. Metatibia with areas adjacent to spurs pale buff. Spurs pearly white. **Forewing:** Metallic spectrum orange with metallic gray outer margin.

4 costal and 3 dorsal, somewhat rectangular spots, metallic gray edged by black laterally; size formula: $C3 > C4 > C2 > C1$; $D1 > D3 > D2$. Outer margin fused with $D3$, edged by black proximally. Extensive black along costa to $C4$, dorsum up to $D1$. Fringe metallic gray. **Hindwing:** Metallic pale black. Fringe metallic gray. **Abdomen:** Metallic gray with extensive cream-yellow along ventral line. **Genitalia:** As in Fig. 89 (drawn from Holotype; $n = 1$). Socii elongate with blunt distal end, possessing an inner tooth near base, approximately 0.5 X tegumen length. Valva flattened, elongate, with slightly enlarged, obtuse distal end. Saccus approximately 1.7 X tegumen length. Phallus straight, stout, with blunt distal tip, approximately 1.3 X longer than tegumen + saccus. Cornuti composed of anterior cone-shaped cluster of long bristles and posterior band-like cluster of short spines.

FEMALE. Unknown.

TYPE MATERIAL: Holotype: ♂: **MEXICO: JALISCO:** Est[ación]. Biol[ogía]. Chamela, 21-22.X.1987, black light (J. A. Chemsak & J. A. Powell, UCB) [EME slide 3591].

GEOGRAPHIC RANGE: (Fig. 17) Mexico (Jalisco).

ETYMOLOGY: This species is named for the state, Jalisco, Mexico.

AETOLE Chambers, revised status
(Figs. 18-25, 36-41, 47-56, 90-104, 133-146, 156, 165,
171-172, 203-218)

Aetole Chambers, 1875: 73.

Aelole Chambers, 1878b: 128. missp.

Aetola Hagen, 1884b: 154. missp.

Type species: *Aetole bella* Chambers, 1875: 73, by monotypy.

Included species: There are 17, listed below under six species groups (Table 1). Key to the species groups is included in the key to genera.

DIAGNOSIS: A8 in male with pleural lobes heavily sclerotized, tergum reduced. Coremata rudimentary. A2 through A7 of pupa bearing 2 lateral setae (instead of 3). Signum an invaginated projection.

Head: Scales behind eyes linear, conspicuous or oblong, inconspicuous externally (Fig. 156). **Thorax:** Metatibia with long, bristle-like or flat scale tuft surrounding apical spurs, dorsally near medial spurs. Additional short, ventral bristle-like or flat scale tuft between medial spurs. Inner medial spur of metatibia less than 1.5 X longer

than outer (Fig. 159). **Forewing:** (Figs. 36-41) 10 veins, R4 and R5 separated or connate. Retinaculum of female a series of arched hairs. **Hindwing:** 5 veins; Rs separate or connate with M1 proximally. Frenulum a single bristle. **Abdomen:** (Figs. 47-56) A8 of male with tergum reduced. Pleura of A8 heavily sclerotized. Coremata reduced to a pair of filiform structures between tergum and pleural lobes of A8. **Male genitalia** (Figs. 90-104): Tegumen deeply divided dorsally or enormously modified. Socii setose sclerites or weakly sclerotized, fused with uncus. Bulbus ejaculatorius joining phallobase terminally or subterminally. **Female genitalia** (Figs. 133-146): Ductus seminalis opening on corpus bursae near base. Signum simple, forming an invaginated spine-like projection. **Early stages:** Larva with two SV setae on A9; a leaf miner. Pupa with two lateral bristles from A2 to A7.

The adult raises the hind legs in repose. This behavior is documented for at least one member of each species group, including all described species except five: *A. insolita*, *A. demarcha*, *A. schulzella*, *A. aprica*, and *A. calciferoides*.

Eximia Group

(Figs. 18, 36, 49, 90-91, 133, 203-204)

Included species: *A. eximia* Hsu, new species; *A. insolita* Hsu, new species.

DIAGNOSIS: Abdomen with an upraised hair tuft subcaudally. Tegumen modified into semimembranous sac bearing 2 heavily sclerotized 'basal processes.' Ductus bursae heavily sclerotized.

Head: Scales behind eyes extremely short, oblong, inconspicuous externally. Antenna approximately 0.80 X FW length. **Thorax:** Metallic gray, pleura pale orange. Outer surface of metatibia with two orange patches. Scale tufts of mesotibia and metatibia prominent, bristle-like. **Forewing:** (Fig. 36) 10 veins. Retinaculum of female a series of arched hairs. Orange largely replaced by very wide metallic gray distal area. **Hindwing:** 5 veins; Rs forked with M1 proximally. **Abdomen:** (Fig. 49) An upraised hair tuft subcaudally. A8 of male with tergum reduced to small sclerotized lobe, sternum forming flat plate folding backward into body cavity. Pleura of A8 an elongate triangular lobe. **Male genitalia** (Figs. 90, 91): Tegumen fused with socii, modified into elongate, cylindrical semimembranous sac. A pair of heavily sclerotized "basal processes" dorsad. Vinculum weakly sclerotized, sac-like. Saccus slender, elongate. Valva enormous, covered by strong spines basally and ventrally. Aedeagus slender, bent, attenuate posteriorly into a sharp distal end. Bulbus ejaculatorius joining phallobase terminally; cornuti absent. **Female genitalia** (Fig. 133): Ventral bridge of apophyses anteriores weakly sclerotized. Apophyses posteriores longer than anteriores, strongly arched subterminally. Sternum A7 with a medial notch posteriorly. Lamella postvaginalis modified, forming an elongate semicircular shield attached firmly to ductus bursae dorsally. Ostium bursae posterior

to A7 sternal notch. Ductus bursae heavily sclerotized at posterior half. Signum an invaginated spine-like process.

Larval hosts are Nyctaginaceae (Order Caryophyllales).

KEY TO SPECIES OF THE EXIMIA GROUP OF *Aetole*

1. FW with 3 metallic gray costal spots. Dorsal edge of valva slightly concave; distal end of basal process on tegumen ax-shaped *eximia*
FW with 2 metallic gray costal spots. Dorsal edge of valva slightly convex, evenly curved; distal end of basal process club-like *insolita*

Aetole eximia Hsu, new species
(Figs. 18, 36, 49, 90, 133, 203)

MALE. FW length 3.2-4.5 mm (3.88 ± 0.54 , $n = 4$). **Head:** Frons, vertex, and antenna metallic gray. Scaling behind eyes brown. Labial palpus cream-white with metallic gray distal tip. **Thorax:** Metallic gray with pleura covered by metallic orange-yellow. Legs metallic gray with coxae paler. Mesotibia with an elongate, metallic flame-scarlet patch. Metatibia with two metallic flame-scarlet patches; anterior one triangular, large, located in front of medial spurs, posterior one small, located between medial and distal spurs. Inner medial spur of metatibia approximately 1.2 X longer than outer. **Forewing:** Metallic gray with double patches of metallic chrome orange at basal half; 3 costal and 1 dorsal rectangular, metallic spots edged by black, all near base. Prominent black distal to C3, sometimes extensive, replacing much of costal orange shade. Fringe metallic gray. **Hindwing:** Metallic gray or pale gray tinged with orange. Fringe metallic gray, orange toward tornus. **Abdomen:** Metallic chrome orange dorsally except metallic black A1 tergum, metallic buff-yellow to gray ventrally with cream-white distal end; cream-white reduced to a small medial patch when venter gray. **Genitalia:** As in Fig. 90 (drawn from EME slide 3665, type locality; $n = 4$). Tegumen weakly sclerotized with slender, pointed saccus. Saccus approximately 0.5 X tegumen length. Basal processes forming two arms with ax-shaped distal ends. Valva enormous, very broad, with ventral edge straight and dorsal edge curved, ending with obtuse distal tip. Phallus bent toward left side, approximately 1.2 X longer than tegumen + saccus.

FEMALE. FW length 3.3-4.6 mm (3.90 ± 0.47 , $n = 6$). Color pattern as described for male. **Genitalia:** As in Fig. 133 (drawn from EME slide 3667, type locality; $n = 2$). Ventral bridge of apophyses anteriores broad, boundary poorly defined. Signum forming single small spine with sharp distal tip.

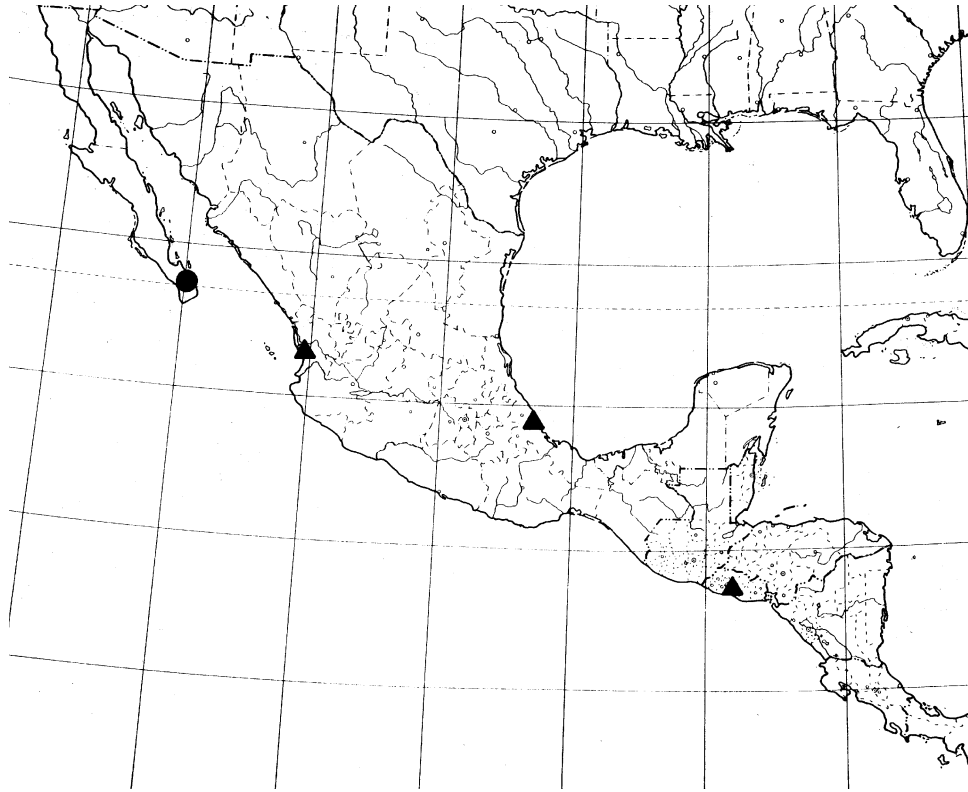

Fig. 18. Map of Mexico showing distribution records for *Aetole eximia* Hsu [circle] and *A. insolita* Hsu [triangles].

TYPE MATERIAL: Holotype: ♂: **MEXICO: BAJA CALIFORNIA SUR:** 2 km SE of San Bartolo, 900', 10-11.XI.1993, reared from *Boerhavia coccinea*, emgd. 7.XII.1993, JAP 93L15 (Y.-F. Hsu, UCB).

4♂, 5♀ paratypes: **MEXICO: BAJA CALIFORNIA SUR:** 4♂, 4♀, same data as holotype, emgd. 3-7.XII.1993, 1♀, same data but reared from *B. gracilima*, emgd. 10.XII.1993, JAP 93L17.1 (Hsu, UCB).

GEOGRAPHIC RANGE: (Fig. 18) Mexico (Baja California Sur).

BIOLOGY: The larvae are leaf miners in *Boerhavia coccinea* Mill. and *B. gracilima* Heimerl (Nyctaginaceae) (JAP 93L15, L17) in Baja California Sur. Larvae collected in November, following the rainy season, produced adults in December; evidently none entered diapause.

ETYMOLOGY: An adjective of Latin origin, *eximia* = exceptional, extraordinary.

PARASITISM: The following Braconidae have been found parasitizing larvae of this species: *Chelonus* sp.; ?*Cyclostome* sp.; unidentified Microgasterinae species (JAP 93L15).

Aetole insolita Hsu, new species
(Figs. 18, 91, 204)

MALE. FW length 3.4-4.0 mm (3.67 ± 0.31 mm, $n = 3$). **Head:** Frons, vertex, and antenna metallic gray. Scaling behind eyes brown. Labial palpus cream-white with metallic gray distal tip. **Thorax:** Metallic gray with pleura covered by metallic orange-yellow. Legs metallic gray with coxae paler. Mesotibia with elongate metallic orange patch. Metatibia with two metallic orange patches; anterior one triangular, large, located in front of medial spurs, posterior one small, located between medial and distal spurs. Inner medial spur of metatibia approximately 1.15 X longer than outer. **Forewing:** Metallic gray with two proximal metallic chrome orange patches. 2 costal and 1 dorsal rectangular-shaped metallic gray spots edged by black, all close to base. Fringe metallic gray. **Hindwing:** Metallic gray or pale gray tinged with orange. Fringe metallic gray, orange toward tornus. **Abdomen:** Basal tergum black, remainder of dorsum metallic chrome orange; metallic buff-yellow to gray ventrally, cream-yellow caudal tip. **Genitalia:** As in Fig. 91 (drawn from holotype; $n = 2$). Tegumen weakly sclerotized with slender, pointed saccus. Saccus approximately 0.50 X tegumen length. Basal processes forming two arms ending with flat, club-like distal ends. Valva enormous, very broad, ovate with slight depression near distal end dorsally; distal end truncated. Phallus bent toward left side, about as long as tegumen + saccus.

FEMALE. Unknown.

TYPE MATERIAL: Holotype: ♂: **EL SALVADOR: LA LIBERTAD:** Quezaltepeque, 500 m, 5.VII.1963 (D. Q. Cavagnaro, M. E. Irwin, CAS).

1 ♂ (+ 1 ex. no abdomen) paratypes: **MEXICO: NAYARIT:** 1 (ex. abdomen missing), San Blas, 18.XII.1963 (C. A. Toschi, M. J. Tauber, UCB). **VERACRUZ:** 1 ♂, Vera Cruz, 6.VIII.1961 (R., K. Dreisbach, MSU).

GEOGRAPHIC RANGE: (Fig. 18) El Salvador (La Libertad); Mexico (Nayarit, Veracruz).

DISCUSSION: *A. insolita* can be distinguished from its sister species, *eximia* by having the distal end of the basal processes club-like rather than ax-shaped; the

valva ovate and broad in contrast to slender, distally tapering in *eximia*; and 2 FW costal spots instead of 3 in *eximia*. Both possess a weakly sclerotized tegumen and prominent, distally enlarged basal processes on the tegumen.

ETYMOLOGY: An adjective of Latin origin, *insolitus* = uncommon, unusual.

Bella Group

(Figs. 19-21, 37, 47-48, 92-95, 134-137, 205-208)

Included species: *A. bella* Chambers, 1875; *A. fulgida* Hsu, new species; *A. prenticei* Hsu, new species; *A. schulzella* (Fabricius, 1794).

DIAGNOSIS: Pleura of A8 semicircular or shield-like in male. Socii elongate with bases close to each other. Sternum A7 modified into a transverse fold.

Head: Scales behind eyes short, oblong, inconspicuous externally. Antenna approximately 0.67 FW length. **Thorax:** Metallic gray, pleura with metallic chrome orange or yellow-orange patch. Area adjacent to spurs metallic black tinged with purple and blue; orange patch on outer surface of metatibia. Scale tufts of mesotibia and metatibia prominent, bristle-like. **Forewing:** (Fig. 37) 10 veins; R4 stalked with R5 proximally; all other veins separate. Ground color orange with broad metallic gray distal margin. Several costal and dorsal metallic spots. **Hindwing:** 5 veins; Rs barely connate with M1 proximally. **Abdomen:** (Figs. 47, 48) A8 of male with tergum and sternum weakly developed; tergum forming a transverse rectangular plate with posterior notch. Pleura of A8 nearly semicircular or shield-like. **Male genitalia** (Figs. 92-95): Tegumen with posterior end truncate. Socii sparsely setose, long, slender with bases close to each other, projecting ventrally. Valva simple, densely setose distally. Aedeagus attenuate posteriorly but slightly swollen before distal end, with dorsal hook distally. Bulbus ejaculatorius semispherical, joining phallobase terminally. Cornuti forming two clusters of bristles at distal end of aedeagus. **Female genitalia** (Figs. 134-137): Ventral bridge of apophyses anteriores broad. Apophyses anteriores shorter than posteriores. Sternum A7 elaborately modified, forming a transverse fold anterior to sinus vaginalis. A pair of scale pouches in A7 transverse fold, absent in *A. prenticei*. Signum a prominent invaginated projection.

Larval hosts are Portulacaceae and Aizoaceae (Order Caryophyllales).

KEY TO SPECIES OF THE BELLA GROUP IN NORTH
AND CENTRAL AMERICA

1. Distal end of valva (cucullus) symmetrically broadened. A7 of female lacking scale pouches under transverse fold of sternum *prenticei*
Distal end of valva only weakly enlarged. A7 of female with scale pouches under transverse fold of sternum 2
2. Valva gradually widened to a slightly attenuate, posteriorly directed tip. Signum tip blunt. *fulgida*
Valva parallel-sided to an abruptly enlarged cucullus. Signum thorn-shaped, acute tipped.. . . . 3
3. Labial palpus mostly white. Socii equal to or longer than tegumen. Signum straight *bella*
Labial palpus gray. Socii shorter than tegumen. Signum curved
. *schulzella*

Aetole bella Chambers, revised combination
(Figs. 19, 37, 47, 92, 134, 205)

Aetole bella Chambers, 1875: 73; 1877: 72; Walsingham, 1881: 324.

Aelole bella; Chambers, 1878b: 128 (name list).

Heliodines bella; Walsingham, 1892b: 384; Dyar, 1903: 537; Busck, 1910a: 183; Meyrick, 1913: 17 (name list), 1914b: 20; Forbes, 1923; Kimball, 1965: 290; Heppner and Duckworth, 1983: 28 (checklist); Covell, 1984: 428; Heppner, 1984: 57 (checklist).

Heliodines sp. "near or *bella*"; Dozier, 1920: 379; Kimball, 1965: 291.

MALE. FW length 3.1-4.5 mm (3.78 ± 0.35 mm, n = 30). **Head:** Frons, vertex, and antenna metallic gray. Labial palpus white with 3rd segment metallic gray. **Thorax:** Metallic gray, pleura with metallic orange patch. Legs metallic gray, basal 1/2 of metatibia orange outwardly. **Forewing:** Metallic reddish orange with metallic gray distal margin; 2 costal and 2 dorsal irregularly shaped, metallic gray spots. Costal spots remote from costa when poorly developed, reaching costa when well developed; proximal one much larger than distal. Metallic gray at base. All spots including distal margin edged in black, sometimes spots and distal margin connected by black. Fringe gray. **Hindwing:** Metallic gray. Fringe gray, white at tornal area. **Abdomen:** Color variable, from uniformly metallic gray with orange scattered dorsally to entirely orange dorsally. Pleural lobe of A8 somewhat triangular. **Genitalia:** As in Fig. 92 (drawn from EME slide 3678, Costa Rica; n = 12). Socii straight, slender, distal end pointed, equal to or slightly longer than tegumen length. Saccus 1.25-1.45 X tegumen

length. Valva elongate, with erect, triangular process at distal end. Phallus approximately 1.5 X tegumen + saccus. Cornuti forming a pair of nearly oval clusters of bristles.

FEMALE. FW length 3.2-4.2 mm (3.74 ± 0.29 mm, $n = 30$). Color pattern as described for male. **Genitalia:** As in Fig. 134 (drawn from EME slide 3672, Ariz.; $n = 11$). Sternum A7 somewhat rectangular with posterior margin nearly straight. A7 transverse fold broad, U-shaped, with a pair of prominent pouches each holding a cluster of flat scales. Ventral bridge of apophyses anteriores triangular with acute posterior end. Signum deeply invaginated, fin-like, straight with acute distal end, approximately 0.23 mm.

TYPE MATERIAL: Neotype: ♀: **U.S.A.: TEXAS: LA SALLE Co.:** Cotulla, 18.IV.1906 (USNM), by present designation. The "syntype" of this taxon deposited in MCZ and listed by Miller and Hodges (1990: 67) is considered a false type; see discussion below.

ADDITIONAL SPECIMENS EXAMINED: **BELIZE: COROZAL:** 1♂, 1♀, Four Mile Lagoon, 16.XII.1994, reared from *P. oleracea*, emgd. by 7.I.1995, JAP 94M4, 1♀, 18.XII.1994, associated with *P. oleracea* (I. S. Hsu, UCB). **COSTA RICA: CARTAGO:** 1♀, Turrialba-grounds of IICA [CATIE], Malaise trap, 0700-1700, 1.VI.1976, 1♂, 2♀, 3/5.VI.1976, 1♀, 14.VI.1976 (M. Wasbauer, UCB). **HONDURAS: COMAYAGUA:** 1♀, Siguatepeque, 10-14.VIII.1978 (J. A. Chemsak, E. G. & J. M. Linsley, UCB), 1♀, 17.VI.1979 1♂, Malaise trap, 23.VI.1979 (J. Chemsak, A. & M. Michelbacher, W. Middlekauff, UCB). **JAMAICA: SURREY:** Kingston, 1♂, Cecidomyia gall on *Portulaca*, emgd. 10.XII.1891 (Cockerell, BMNH). **MEXICO: BAJA CALIFORNIA SUR:** 7♂, 5♀, 2 km SE San Bartolo, 900', 10-11.XI.1993, reared from *Portulaca oleracea*, emgd. 29.XI to 14.XII.1993, JAP 93L23 (Y.-F. Hsu, UCB). **CHIAPAS:** 1♂, Suchiapa, 18.VII.1957 (P. D. Hurd, CAS). **CHIHUAHUA:** 1♂, 20 mi. SE Chihuahua, 13.VII.1964 (Powell, UCB). **DURANGO:** 1♂, Lerdo, 20.VIII.1918 (USNM). **JALISCO:** 2♂, Puerto Vallarta, 30.XII.1970, sea level (P. H. & M. Arnaud, CAS). **PUEBLA:** 1♂, 7 km W Tlacotepec, 1950 m, 23.VIII.1987 (J. W. Brown, Powell, UCB). **NICARAGUA: MANAGUA:** 1♂, 1♀, La Calera, 7.IV.1964, larva attached on *P. oleracea*, emgd. 20.IV.1964 (L. Saenz, USNM). **U.S.A.: ARIZONA: COCHISE Co.:** 1♀, Chiricahua Mts., Rustler Park, 8500', 4.IX.1959 (D. D. Linsdale, UCB); 1♀ + 1 ex (abdomen damaged), 2 mi NE Portal, 9.IX.1959 (P. H. Arnaud, CAS); 2♀, 8 km W Portal, Southwestern Research Sta., 1645 m, 7.IX.1966 (P. H. Arnaud, CAS); 1♀, 1 mi S Portal, Stewart Camp, 12-15.VIII.1971 (Powell, UCB); 5♂, 4♀, 3 mi NW Chiricahua, 5.VIII.1991 (Hsu, Powell, UCB, BMNH). **PIMA Co.:** 1♂, 1♀, T19S, R16E, S18, 9-10.X.1960 (R. W. Hodges, USNM). **SANTA CRUZ Co.:** 3♂, Santa Rita Mts., Madera Cyn., 4880', 6-24.IX.1959. (R. W. Hodges, USNM). **ARKANSAS: GARLAND Co.:** 1♂, Hot Springs, VI.22. [no year given] (H. S. Barber, LACM). **CALIFORNIA: LOS ANGELES Co.:** 1 ex (abdomen missing), [no further data]; 4♂, 1♀, Pasadena, 14.IX.

[no year given] (J. E. Graf, USNM). **RIVERSIDE Co.:** 4♂, 2♀, Riverside, IX.1929, on Goldenrod, 21♂, 81♀, 28.VIII.1930, 1♂, 6♀, 25.XII.1933, 1♂, 29.IX.1936, reared [no host plant given], 5♂, 7♀, 3.IX.1939 (all C. M. Dammers, UCB, LACM, USNM, BMNH); 5♂, 1♀, same locality, on flowers, 14.IX.1928 (W. H. Thorpe, USNM); 1♂, same locality, 25.IX.1940 (G. H. & J. L. Sperry, LACM). **SAN DIEGO Co.:** 1♂, Coronado, 1.XII.[18]90 (F. E. Blaisdell, CAS). **COLORADO: ADAMS Co.:** 1♂, Denver, Chimney Gulch, 13.VI.1888 (LACM). **FLORIDA: ALACHUA Co.:** 1♀, Gainesville, 21.V.1916, on Chinquapin bloom (H. L. Dozier, USNM); 1♂, same locality, on *Portulaca* sp., 21.XI.1972 (D. H. Habeck, FSCA). **BROWARD Co.:** 3♂, Ft. Lauderdale, 1.X.1979 (J. DeFillippis, FSCA). **DADE Co.:** 2♂, 2♀, 4 mi NW Homestead, Subtropical Research Sta., 10.VI.1974, at black light (J. B. Heppner, FSCA); 1♂, Long Pine Key, Everglades National Park, 26.IV.1975, at black light (Heppner, FSCA); 1♂, Grossman Hammock, Chekika State Recreation Area, 29.IV.1975, at light (Heppner, FSCA). **HARDEE Co.:** 3♂, 1♀, Wauchula, 31.X.1986, reared from *Portulaca oleracea*, emgd. 20.XI.1986 (G. Johnson, FSCA). **HIGHLANDS Co.:** 1 ex (abdomen missing), 10 mi S Lake Placid, Archbold Biol. Sta., 9.V.1975 (Heppner, FSCA). **MANATEE Co.:** 1♂, Palmasola, 2.XI.1972, reared from *Portulaca* sp., emgd. 19.XI.1972 (Habeck, FSCA). **MONROE Co.:** 1♂, Key Largo, 5.IX.1965 (S. Kemp, UCB). **SARASOTA Co.:** 1♀, Siesta Key, 6.XII.1953 (C. P. Kimball, USNM). **KANSAS: POTTAWATOMIE Co.:** 1♂, Onaga [no further data] (Crevecoeur, USNM). **NEW MEXICO: OTERO Co.:** 1♀, Bent, 7000', X.1927 (Meyrick Coll., BMNH). **OKLAHOMA: OKLAHOMA Co.:** 1♂, Oklahoma City, 25.VIII.1955, 2♂, 18.VII.1956, 2♂, 6♀ 8.VIII.1956 (all D. R. Davis, USNM). **TEXAS: EL PASO Co.:** 1♂, El Paso, Sta. Fe St. Bridge [to] Mexico, on Purslane [= *Portulaca*], 24.VII.1941, emgd. 30.VII.1941, Lot No. 41-J4391 (USNM) [presumably quarantine interception from Mexico].

GEOGRAPHIC RANGE: (Fig. 19) U.S.A. (Arizona, California, Colorado, Florida, Kansas, New Mexico, Oklahoma, Texas), also Kentucky according to Dyar (1903), Forbes (1923), and Covell (1999); Mexico (Baja California Sur, Chiapas, Chihuahua, Durango, Jalisco, Puebla); Jamaica (Surrey); Belize (Corozal); Honduras (Comayagua); Nicaragua (Managua); Costa Rica (Cartago).

GEOGRAPHIC VARIATION: Northern populations have uniformly gray abdomens, whereas specimens from Central America all have the abdomens orange dorsally. Intermediate populations occur in southern California (USNM specimens) and Baja California, Mexico, where a single rearing lot (JAP 93L23) produced individuals with uniformly gray, gray with scattered orange dorsally, and gray with extensively orange dorsally.

SEASONAL VARIATION: A series of old specimens (USNM) from southern California collected in December consists of darker individuals, evidently showing a tendency produced by low temperature conditions, while the specimens collected

in August, September, and November from the same site are paler (LACM, USNM, UCB specimens).

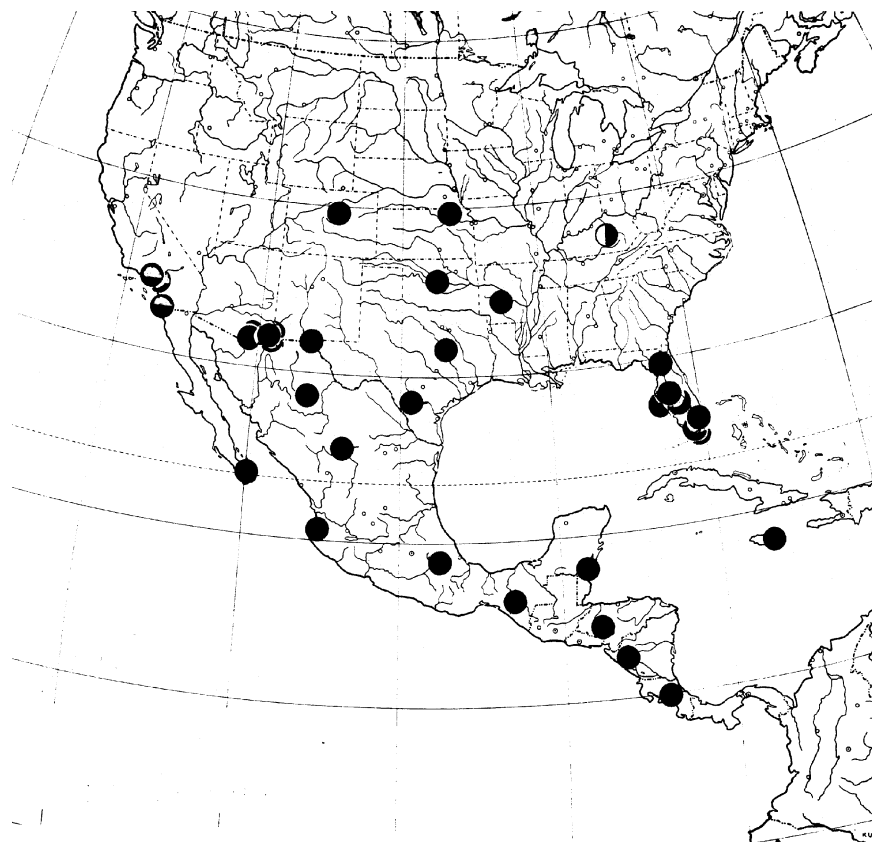

Fig. 19. Map of North America showing distribution records for *Aetole bella* Chambers; side-open circle = KY state record; top-open circles = adventive populations now extinct (as may be true of many other records).

BIOLOGY: The larval host is *Portulaca oleracea* L. (Portulacaceae) in Baja California Sur, Mexico (JAP 93L23), Belize (JAP 94M4), Nicaragua (USNM specimens), and Florida, U.S.A. (FSCA specimens). Unidentified *Portulaca* are used in Florida (FSCA specimens), Jamaica (BMNH specimen), and Texas (USNM specimen). Presumably native *Portulaca* species are utilized because *P. oleracea* is an introduced plant from the Old World (Kelley 1993), and the moth is not known from the Old World. Covell's (1984) records of "Chinquapin blossoms" and "velvetbean" (*Stizolobium*) evidently are based on Forbes (1923) and Kimball (1965) and may refer to adult collection records rather than larval host plants. The moths visit various flowers.

The larva is a leaf miner (FSCA specimens, JAP 93L23, 94M4) or bores into

cecidiomyiid galls (BMNH specimen). The fully grown larva often stays in a silk network outside of the mine. It may bore and embed itself completely into a soft stem when leaves are unavailable (JAP 93L23). Pupation occurs outside of the mine. The adult raises its hind legs in repose.

Following the introduction of *Portulaca oleracea* into the New World and the adoption of it by *Aetole bella*, this moth may have dispersed to new territories as *P. oleracea* became a widespread and common weed. Native *Portulaca* remain uncommon, found only in restricted habitats (Kelley 1993). In California *A. bella* was recorded beginning in 1890, and long series were collected during the 1930s, but there are no records since 1940. Recent efforts to recover it have been unsuccessful, suggesting a temporary colonization.

PARASITISM: The following species have been found parasitizing larvae of this moth: *?Parapanteles* sp.(JAP 93L23); unidentified Microgasterinae species (Braconidae) (JAP 93L23, 94M5).

DISCUSSION: *Aetole bella* was originally described from Texas. Although Chambers did not give a type locality, the published title was “Tineina from Texas,” and he stated in the introduction that he had received the collection from “Mr. Belfrage, of Waco, Texas” (Chambers 1874: 224). According to Geiser (1948), Belfrage lived near Norse, Bosque County [about 55 airline km northwest of Waco, McLennan Co.] from 1870 to 1879. Material received from Belfrage and described by Walsingham that was collected in 1874 is labelled “Bosque Co., Texas” (e.g., Walsingham 1892b). Hence the precise type locality of *A. bella* is unknown but likely was in Bosque County. The statement by Covell (1999) that the type locality of *bella* is Kentucky, citing Chambers (1873) is in error.

There is confusion about the taxonomic status of many of Chambers's species (e.g., Braun 1923, Miller and Hodges 1990). The alleged Chambers syntype of *Aetole bella* from Texas (MCZ), cited by Miller and Hodges, does not match Chambers's original description. There are three obvious points of disagreement: (1) *A. bella* should have a “dark slate brown” abdomen; (2) it should have a reddish orange patch on the outer surface of the metatibia; and (3) it should have veins R4 and R5 of forewing stalked. However, the alleged syntype has a metallic orange abdomen, lacks the orange patch on the metatibia, and has vein R5 separate from R4. In fact, it agrees well with another species, *Aetole tripunctella*, a member of a different species group, described by Walsingham (1892b), also from Belfrage, in Texas.

Chambers (1880) illustrated the wing venation of an alleged *A. bella*, but his figure matches *A. tripunctella*, a discrepancy noticed by Walsingham (1881). Thus Chambers had confused the two species within a few years of having described *A. bella*. On the other hand, Busck's (1910a) key to the then-known *Heliodines* of the North America differentiates *A. bella* in agreement with Chambers's original description and *A. tripunctella* with Walsingham's. Busck's treatment was followed by later workers (e.g., Forbes 1923, Covell 1984, Harrison and Passoa 1995).

Resolution of the status of *A. bella* is crucial not only to the nomenclatural

stability of this taxon and *A. tripunctella* but also to the generic name *Aetole*, of which *bella* is the type species. To reinforce the stability of nomenclature, we consider the presumed syntype in the MCZ (Miller and Hodges 1990) to be a false type and designate a neotype that matches Chambers' original description in every aspect and is also from Texas. Following this designation, the venation of the moth shown by Chambers (1880: Fig. 54), which has vein R4 and R5 separated (Fig. 48), is regarded as *A. tripunctella*, not *A. bella*. The venation of *A. bella* (Fig. 47) has R4 fused with R5 proximally.

Aetole schulzella (Fabricius), new combination
(Figs. 20, 93, 135, 206)

Tinea schulzella Fabricius, 1794: 321; 1798: 498.

Heliodines schulzella; Walsingham, 1897: 109; Meyrick, 1913: 17 (name list), 1914b: 20; Forbes, 1930: 104.

Heliodines quinqueguttata Walsingham, 1897: 109; Meyrick, 1913: 17 (name list); Meyrick, 1914b: 20; Forbes, 1930:104; Wolcott, 1936: 485 (checklist). NEW SYNONYMY.

MALE. FW length 3.6-4.6 mm (4.00 ± 0.28 mm, $n = 15$). **Head:** Frons, vertex, and antenna metallic gray. Labial palpus metallic gray. **Thorax:** Metallic gray, pleura with metallic orange patch. Legs metallic gray. Areas adjacent to metatibia metallic black; distal ends of metatarsomeres also metallic black. Orange patch on metatibia sometimes reduced or absent. Inner medial spur of metatibia approximately 1.2 X longer than outer. **Forewing:** Metallic spectrum orange with outer 1/3 metallic gray. A subapical, medial, metallic deep purple patch; 4 costal and 2 dorsal metallic gray spots. All spots and outer margin edged irregularly by black; size formula: $C3 > C2$, $C4 > C1$, $D1 \geq D2$; C2 and C3 frequently remote from costa. Fringe metallic gray. **Hindwing:** Metallic gray. Fringe metallic gray. **Abdomen:** Metallic dark brown with cream-white terminal end, partially or entirely replaced by metallic chrome orange in some specimens. A2, A3, and A4 banded with metallic gray but obscure in some specimens. Pleural lobe of A8 somewhat triangular. **Genitalia:** As in Fig. 93 (drawn from YFH slide 1045, Puerto Rico, USNM; $n = 4$). Socii short, stout, approximately 0.5 X tegumen length, posterior end down-curved. Saccus approximately 2.3 X tegumen length. Valva broad, straight or slightly concave ventrally, distal end somewhat obtuse. Phallus approximately 1.45 X longer than tegumen + saccus. Cornuti forming two ovate clusters of bristles.

FEMALE. FW length 3.3-4.3 mm (3.87 ± 0.36 mm, $n = 7$). Color pattern as described for male except terminal end of abdomen not cream-yellow. **Genitalia:** As in Fig. 135 (drawn from EME slide 4165, Trinidad; $n = 1$). Sternum A7 semicircular with posterior margin obtuse. A7 transverse fold shallow, widely opened, V-shaped with a pair of pouches each holding a small circular cluster of flat scales. Ventral bridge of apophyses anteriores triangular with acute posterior end. Signum deeply

invaginated, fin-like, curved near distal end, approximately 0.30 mm.

TYPE MATERIAL: Lectotype: ♂ (designated here): Labeled “Schulzella, TYPE, Zool. Museum DK Copenhagen” [No locality given, probably St. Croix or St. Thomas of the Virgin Islands according to Walsingham (1897) and Forbes (1930)] (ZMUC, YFH Genitalia slide 0941). ♂ holotype of *Heliodines quinqueguttata*, **DANISH WEST INDIES: SANTO TOMAS**, 23.III.1894 (Hedemann, BMNH, slide no. 9379).

4♂ paratypes of *H. quinqueguttata* examined: **DANISH WEST INDIES [= U.S. Virgin Islands]: SANTO TOMAS**, 1♂, 23.III.1894 (Hedemann, BMNH); 1 same locality, 11.III.1894, 1♂, emgd. 12.IV.1894 (“H_dmann” [Hedemann], BMNH). **JAMAICA: SURREY: KINGSTON**: 1♂, Kingston emgd. 10.XII.1891 (Cockerell, BMNH).

ADDITIONAL SPECIMENS EXAMINED: CUBA: LA HABANA: 1♀, Santiago de las Vegas, 8.XI.1932 (A. Otero, USNM). **GUANTANAMO**: 1 specimen (abdomen missing), Baracoa, IX.1912 (A. Busck, USNM). **JAMAICA: MIDDLESEX: ST. ANN**: 1♂, Runaway Bay, 24.II.1905 (Walsingham, BMNH). **PUERTO RICO**: 1♀, Culebra, 1.II.1899 (A. Busck, USNM); 1♂, Aguirre Central, 2/3.IV.1932 (Leonard, Mills, USNM). **TRINIDAD**: 1♀, Mt. Lambert, 15.II.1961 (N. Gopaul, CNC); 1♀, Fort George, X.1970, leaf miner of *Portulaca oleracea* (F. D. Bennett, BMNH), 5♂, 3♀, Curepe, I/II.1971, 1 larva ex *P. oleracea* (Bennett, BMNH, UCB); 1♂, San Juan, I.1971, associated with *P. oleracea* (Bennett, BMNH); 1♀, Montserrat, III.1971, reared from *P. oleracea* (F. D. Bennett, BMNH). **U.S.A.: FLORIDA: DADE Co.**: 2♂, Subtropical Res. Sta. 4 mi NW Homestead, 10.VI.1974, black light (J. B. Heppner, FSCA).

GEOGRAPHIC RANGE: (Fig. 20) U.S.A. (Florida); Cuba (La Habana, Guantanamo); Jamaica (Middlesex); Puerto Rico; U.S. West Indies (Santo Tomas); Trinidad.

VARIATION: Some individuals have black more prominent than others. The number of specimens examined was insufficient to determine if the melanism is seasonal.

BIOLOGY: This species was reared from cecidomyiid galls on *Portulaca* sp. in Jamaica by Cockerell (Walsingham 1897) and as a leaf miner on *Portulaca oleracea* by F. D. Bennett in Trinidad (BMNH specimens). Hedemann observed that larvae live in fine webs on the underside of the leaves from which they mine into the leaves when feeding (Walsingham 1897). Presumably feeding in cecidomyiid galls is an opportunistic expression of the facultative mining behavior.

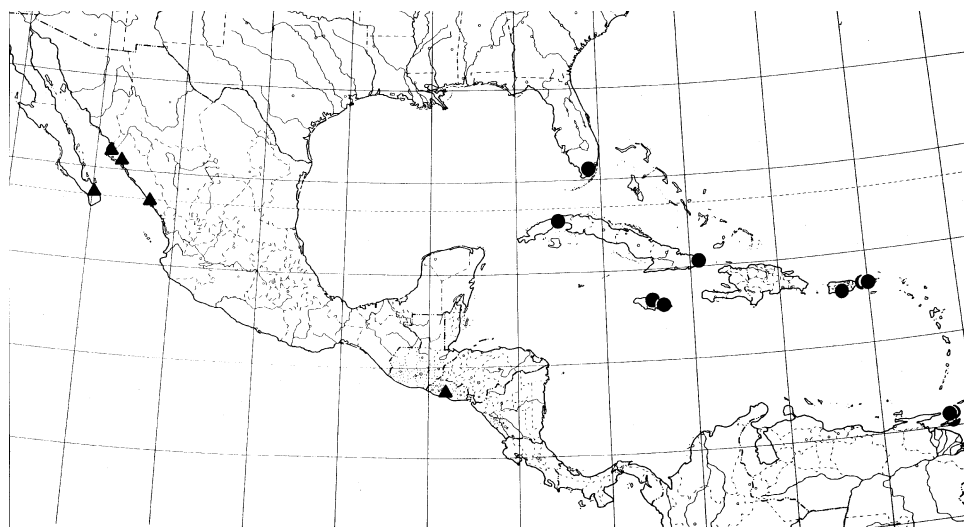

Fig. 20. Map of Mexico and Caribbean region showing distribution records for *Aetole fulgida* Hsu [triangles] and *A. schulzella* (F.) [circles].

REMARKS: Two specimens were represented in the type series of *Aetole schulzella* (Fabricius) according to Zimsen (1964), but we saw only one of the syntypes; it is designated as the lectotype.

DISCUSSION: *Aetole quinqueguttata* (Walsingham) was originally separated from *A. schulzella* by the absence of “a black costa” on the forewing (Walsingham 1897). However, the extent of black on the forewing is variable in this species. The genitalia of the types of *A. schulzella* and *A. quinqueguttata* are not appreciably different.

Aetole fulgida Hsu, new species
(Figs. 20, 94, 136, 165, 171, 207)

MALE. FW length 3.6–4.8 mm (4.06 ± 0.50 mm, $n = 5$). **Head:** Frons, vertex, and antenna metallic gray tinged with orange. Labial palpus cream-white with metallic gray distal tip. **Thorax:** Metallic gray tinged with orange, pleura with orange patch. Legs metallic gray, pale gray proximally on inner surfaces; procoxa orange on outer surface; metatibia orange on both outer and inner surfaces. **Forewing:** Metallic spectrum orange with metallic gray outer margin; 3 costal and 2 dorsal metallic gray spots incompletely edged with black; size formula: $C2 > C1 > C3$; $D2 > D1$. Outer margin edged by black proximally. In some specimens black greatly extending, covering distal 1/3 of forewing. A basal metallic gray spot along costa. Fringe gray. **Hindwing:** Metallic gray. Fringe brown. **Abdomen:** Metallic spectrum orange with

tergum A1 metallic gray and sterna A1 through A4 metallic gray tinged with white. Pleural lobe of A8 semicircular. **Genitalia:** As in Fig. 94 (drawn from EME slides 3683, Sinaloa, and 3681 aedeagus, Baja Calif.; n = 4). Socii comparatively short and stout, approximately 0.75 X of tegumen length, posterior end curved, pointed. Saccus approximately 2.4 X tegumen length. Valva broad, flat, with distal end bluntly angled dorsally and rounded ventrally. Phallus approximately 1.45 X tegumen + saccus. Cornuti forming two elongate clusters of bristles.

FEMALE. FW length 3.5-4.4 mm (n = 2). Color pattern as described for male. **Genitalia:** As in Fig. 136 (drawn from EME slide 3682, Baja Calif. Mex.; n = 2). Sternum A7 semicircular with posterior margin convex, forming deep, somewhat U-shaped fold with two lateral pouches each with a cluster of flat, internal scales. Ventral bridge of apophyses anteriores forming broad triangular sclerite projecting posteriorly. Signum deeply invaginated, fin-like, straight, approximately 0.27 mm.

TYPE MATERIAL: Holotype: ♂: **MEXICO: SINALOA:** 5 mi N Mazatlan, 11.X.1975, at light (J. Powell, J. Chemsak, T. Eichlin, and T. Friedlander, UCB).

4♂, 2♀ Paratypes: **EL SALVADOR: LA LIBERTAD:** 1♀, Quezaltepeque, 500 m, 5.VII.1963 (D. Q. Cavagnaro, M. E. Irwin, CAS). **MEXICO: BAJA CALIFORNIA SUR:** 2♂, 1♀, 2 km SE San Bartolo, 900', 10-11.XI.1993, reared from *Portulaca oleracea*, emgd. 8/27.XII.1993 (Y.-F. Hsu, UCB). **SINALOA:** 1♂, 13 mi N Los Mochis. 7.VIII.1964, black and white lights (Chemsak, Powell, UCB); 1♂, 20 mi E Guasave, 21.VIII.1969 (J. T. Doyen, J. Haddock, UCB).

GEOGRAPHIC RANGE: (Fig. 20) El Salvador (La Libertad); Mexico (Baja California Sur, Sinaloa).

BIOLOGY: The larval host is *Portulaca oleracea* L. (Portulacaceae) in Baja California Sur (JAP 93 L23.1). The larva is a leaf miner. The adult raises its hind legs in repose.

ETYMOLOGY: An adjective of Latin origin, *fulgidus* = shining.

Aetole prenticei Hsu, new species
(Figs. 21, 48, 95, 137, 159, 208)

MALE. FW length 2.9-3.8 mm (3.38 ± 0.42 mm, n = 30). **Head:** Frons, vertex, and antenna metallic gray. Labial palpus cream-white with metallic gray tip. **Thorax:** Metallic gray, pleura with orange patch, sometimes scattered orange on terga, patagia sometimes orange. Legs pale metallic silvery gray with terminal end of each tarsomere metallic black. Metallic orange on both outer and inner surfaces of metatibia, on outer surface of mesotibia, and sometimes on 1st protarsus. **Forewing:** Metallic spectrum

orange to chrome orange with distal margin black tinged with reddish purple. Distal margin intercepted by a medial metallic gray patch and connected with a posterior metallic gray or white patch; 4 costal and 2 dorsal, orbicular or square spots, C1, C3, and C4 subequal, C2 larger, extended to join D1; metallic gray or whitish gray edged irregularly by black. Proximal three costal spots remote from costa; distal spot often fused with distal margin. Distal dorsal spot much smaller than proximal, sometimes fused with posterior gray patch of outer margin. Metallic gray at base, sometimes fused with C1; C4 spot sometimes white. Fringe pale gray to dark gray. **Hindwing:** Metallic gray. Fringe gray. **Abdomen:** Metallic gray mixed with black dorsally, metallic pale silvery gray ventrally. Distal segments, especially A5 and A6, metallic purplish black. Distal segments sometimes orange laterally. Terminal end of abdomen brownish in some specimens. Pleural lobe of A8 shield-like with acute medial, pointed projection. **Genitalia:** As in Fig. 95 (drawn from EME slide 4161, Grizzly Island; n = 8). Socii approximately 0.7 X tegumen length, basal half enlarged dorsally, then tapering to acute distal end, curved downward. Saccus approximately 2.7 X tegumen length. Valva elongate with distal end club-like. Phallus approximately 1.55 X tegumen + saccus. Cornuti forming two ovate clusters of bristles.

FEMALE. FW length 3.0-3.9 mm (3.49 ± 0.22 mm, n = 30). Color pattern as described for male but terminal end of abdomen not brownish. **Genitalia:** As in Fig. 137 (drawn from EME slide 3703, Grizzly Island; n = 4). Sternum A7 semiobovate with posterior margin obtuse. A7 transverse fold shallow, widely open V-shaped. Scale pouches absent. Ventral bridge of apophyses anteriores broad with obtuse posterior end. Signum shallowly invaginated, obtuse-angled, triangular with blunt distal end, approximately 0.23 mm.

TYPE MATERIAL: Holotype:♂: **U.S.A.: CALIFORNIA: SOLANO Co.:** Grizzly Island, 30.VIII.1992, reared from *Sesuvium verrucosum*, emgd. 18.IX.1992, JAP 92H34 (Y.-F. Hsu, UCB).

178♂, 137♀ paratypes: **U.S.A.: ARIZONA: YUMA Co.:** 1♂, 2♀, Territorial Prison State Historical Park, just N of Yuma, 16.VI.1993, reared from *Sesuvium verrucosum*, emgd. 28.VI/2.VII.1993, JAP 93F33 (Hsu, UCB). **CALIFORNIA: CONTRA COSTA Co.:** 2♂, Antioch Natl. Wildlife Refuge (SP), black light, 20.IX.1990 (Powell, UCB). **FRESNO Co.:** 1♀, Mendota Wildlife Area, 8.IX.1992, associated with *S. verrucosum*, 1♂, 8.IX.1992, reared from *S. verrucosum*, emgd. 25.IX.1992, JAP 92J8 (Hsu, UCB). **KERN Co.:** 1♀, N shore of Buena Vista Lake (Lake Webb), 300', 25.VII.1994, reared from *S. verrucosum*, emgd. 16.VIII.1994, JAP 94G26 (Hsu, UCB). **MERCED Co.:** 1♂, 3♀, Kesterson Nat'l. Wildlife Refuge, 5.IX.1992, associated with *S. verrucosum*, 28♂, 25♀, 5.IX.1992, reared from *S. verrucosum*, emgd. 6.IX to 17.X.1992, JAP 92J5 (Hsu, UCB); 1♂, Los Banos Wildlife Area, 8.IX.1992, associated with *S. verrucosum*, 2♀, 8.IX.1992, reared from *S. verrucosum*, emgd. 28.IX to 4.X.1992, JAP 92J9 (Hsu, UCB). **RIVERSIDE Co.:** 1♂, 14 mi NE Mecca, 4.VI.1981, at black light (J. Doyen, J. Liebherr, UCB); 2♂, 2♀, 9

mi S Coachella, W of Salton Sea, -220', 3.X.1993, reared from *S. verrucosum*, emgd. 24.X to 3.XI.1993, JAP 93K6 (Hsu, UCB). **SOLANO Co.:** 24♂, 9♀ Grizzly Island, 10.X.1991, assoc. *Sesuvium verrucosum*, 16♂, 12♀ reared from *S. verrucosum*, emgd. 21.X to 5.XI.1991, JAP 91K9 (Powell, UCB); 3♂, 5♀, same locality, 12.X.1991, reared from *S. verrucosum*, emgd. 21.X.1991, JAP 91K14, 7♂, 1♀, 28.III.1992, reared from *S. verrucosum*, emgd. 14-27.IV.1992, 92C108, 7♂, 5♀, 12.VII.1992, 25♂, 19♀, 12.VII.1992, reared from *S. verrucosum*, emgd. 17.VII to 17.VIII.1992, JAP 92G19, 25♂, 21♀, same data as holotype, emgd. 11. IX to 2.X.1992, JAP 92H34 (all Y.-F. Hsu, UCB, UCONN, BMNH, USNM); 25♂, 16♀, Lagoon Valley Park, 29.IX.1992, reared from *S. verrucosum*, emgd. 12/24.X.1992, JAP 92J42 (Hsu, UCB). **IMPERIAL Co.:** 6♂, 8♀, Imperial Wildlife Area, at SE end Salton Sea, 28.IV.1993, reared from *S. verrucosum*, emgd. 18.V to 6.VI.1993, JAP 93D42 (Hsu, UCB). **NEW MEXICO: CHAVES Co.:** 1♀, Bitter Lake Natl. Wildlife Refuge, 3200', 19.VI.1993, associated with *S. verrucosum*, 3♂, 4♀, 19.VI.1993, reared from *S. verrucosum*, emgd. 24.VI to 29.VII.1993 (Hsu, UCB).

GEOGRAPHIC RANGE: (Fig. 21) U.S.A. (Arizona, California, New Mexico).

BIOLOGY: The larval host plant is *Sesuvium verrucosum* Raf. (Aizoaceae) in California (JAP 91K9, 91K14, 92C108, 92G19, 92H34, 92J5, 92J8, 92J9, 92J42, 93D42), Arizona (JAP 93F33), and New Mexico (JAP 93F44). The larva is a leaf miner. Pupation occurs outside of the mine in a groove made by the larva in the leaf surface, observed in the field (JAP 92J5, J9). The adult raises its hind legs in repose.

PARASITISM: The following species were reared from field-collected larvae of *A. prenticei*: unidentified Pteromalinae species (Pteromalidae)(JAP 92J5, 92J42); *Pnigalio* sp. (Eulophidae)(JAP 91K9, 92J5, 92J42).

ETYMOLOGY: This species is named for Dr. Michael A. Prentice. His observation of adults at the type locality led to the discovery of this species and its host plant, which facilitated subsequent survey for it.

REMARKS: The host is widespread but colonial, typically growing on margins of wetlands generally on saline, seasonally wet soil in dry, arid environments. The discontinuous distribution of the host limits the availability of the larval food, and occurrences of the moth are widely isolated. Curiously this moth has been found on

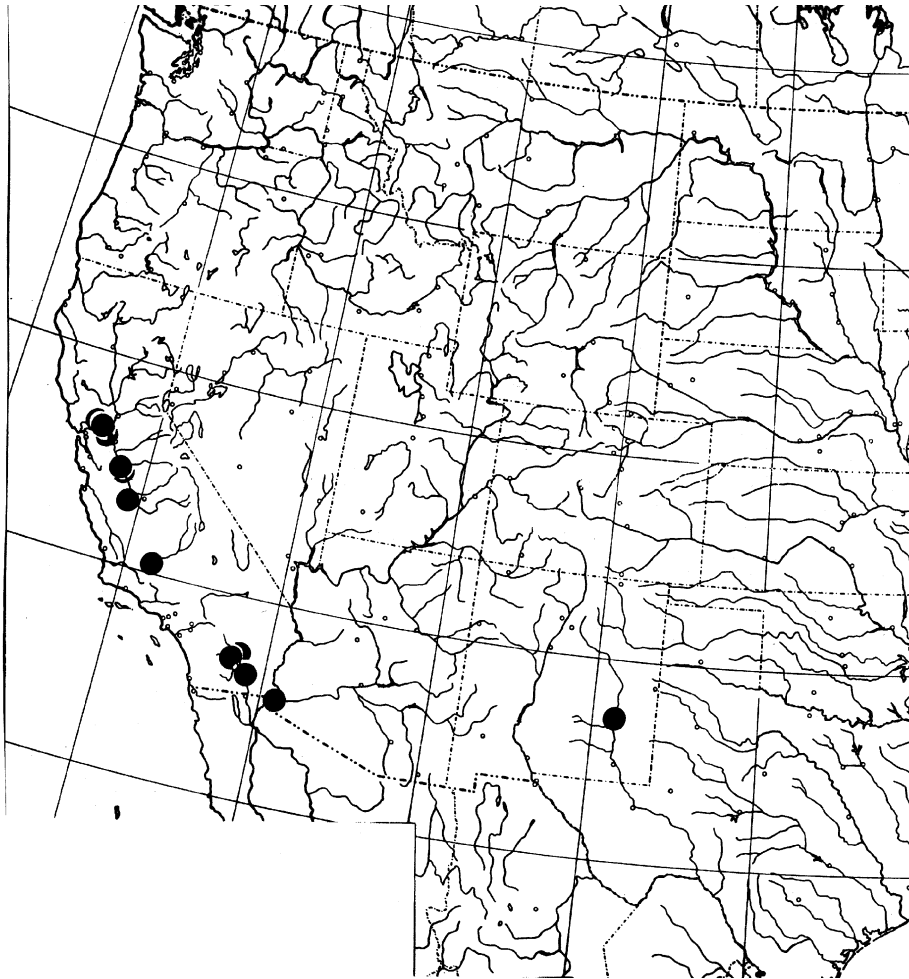

Fig. 21. Map of southwestern United States showing distribution records for *Aetole prenticei* Hsu.

almost every site where we found the host. This suggests an ability for long-distance dispersal of this small moth; two specimens were taken at blacklight at the Antioch National Wildlife Refuge, California, several km from any known *Sesuvium*.

Tripunctella Group

(Figs. 22-23, 38, 51-54, 96-100, 138-142, 209-214)

Included species: *A. cera* Hsu, new species; *A. favonia* Hsu, new species; *A. inusitata* Hsu, new species; *A. aprica* Hsu, new species; *A. tripunctella* (Walsingham,

1892), new combination; *A. unipunctella* (Walsingham, 1892), new combination.

DIAGNOSIS: Metatibia with 3 black spots on outer side. Posterior margin of A7 in female with a midventral notch. Tergum of A8 a weakly sclerotized lobe; pleura in male with heavily sclerotized, prominent ventral process anteriorly and dorsal process posteriorly.

Head: Scales behind eyes short, inconspicuous externally. Antenna approximately 0.67 FW length. **Thorax:** Metallic gray with a metallic orange, pleural patch. Three metallic black spots on outer surface of metatibia; one in front of medial spurs, one around apical spurs, one between those two. Scale tufts of mesotibia and metatibia prominent, bristle-like. **Forewing:** (Fig. 38) 10 veins, all separate. Ground color orange or scarlet with a metallic gray or silver distal margin or with distal half of wing gray. **Hindwing:** 5 veins; Rs connate with M1 proximally. **Abdomen:** (Figs. 51-54) A8 of male with tergum a weakly sclerotized lobe, sternum membranous. Pleura of A8 heavily sclerotized, forming plates with slender, elongate ventral process extending anteriorly and robust, elongate dorsal digitate process extending posteriorly. Sternum of A7 forming a midventral notch posteriorly, ostium bursae within notch. **Male genitalia** (Figs. 96-100): Tegumen divided dorsally into two symmetrical parts; vinculum modified laterally into elongate process extending anteriorly. Socii short, digitate, dorsally close to full contact with the ventral edge of tegumen. Saccus 0.95-1.45 X longer than tegumen. Valva elongate with a robust stalk. Aedeagus attenuate posteriorly into narrow distal end. Bulbus ejaculatorius attenuate into a lanceolate tip, connected with phallobase terminally; vesica heavily sclerotized into a sheath with cornuti forming single spine. **Female genitalia** (Figs. 138-142): Ventral bridge of apophyses anteriores somewhat triangular or V-shaped. Apophyses anteriores shorter than posteriores. Ductus bursae shorter than corpus bursae. Signum simple, forming an invaginated fin-like projection.

Larval hosts are Nyctaginaceae (Order Caryophyllales).

KEY TO SPECIES OF THE TRIPUNCTELLA GROUP OF *Aetole*

1. FW with a transverse metallic gray band at basal 1/3 2
 FW with basal transverse band divided into two separate spots . . . *tripunctella*
2. Distal end of socii sharply attenuated. Ductus bursae heavily sclerotized
 *unipunctella*
 Distal end of socii blunt. Ductus bursae membranous or sclerotized only at base
 3
3. Abdomen mostly orange 4
 Abdomen gray or silvery dorsally with two metallic orange patches laterally 5

4. Labial palpus with basal 1/2 white; metatibia with orange patches. Pleura of A8 lacking long process *inusitata*
 Labial palpus gray; metatibia lacking orange patches. A8 pleura with slender, long, pointed process *aprica*
5. Midventral notch of A7 sternum in female extending more than 1/3 the length of A7. Basal sclerite of ductus bursae lacking medial cleft *cera*
 Midventral notch of A7 sternum in female extending only 1/4 the length of A7. Basal sclerite of ductus bursae with V-shaped, medial cleft *favonia*

Aetole tripunctella (Walsingham), new combination
 (Figs. 22, 38, 51, 96, 138, 209)

Heliodines tripunctella Walsingham, 1892b: 384; Dyar 1903: 537; Busck, 1910: 183; Meyrick, 1913: 17 (name list), 1914b: 20; Heppner and Duckworth, 1983: 28 (checklist); Harrison and Passoa, 1995: 68.

Heliodines perichalca Meyrick, 1912: 58, 1913: 17 (name list), 1914b: 20; Heppner and Duckworth, 1983: 28 (checklist). NEW SYNONYMY.

MALE. FW length 3.8-5.0 mm (4.37 ± 0.35 mm, $n = 30$). **Head:** Frons, vertex, and antenna metallic dark gray. Scaling behind eyes dark brown, barely visible exteriorly. Labial palpus metallic gray with whitish base and black tip. **Thorax:** Metallic gray, pleura covered with bright metallic orange. Legs metallic gray with prominent metallic black spots. Inner medial spur about 1.2 X longer than outer one. **Forewing:** Metallic chrome orange edged by elongate metallic gray tinged with blue outer margin extending inward over 1/2 of dorsum and 1/3 of costa; 3 costal and 1 dorsal metallic gray spots tinged with blue, C1 in close contact with proximal base; C3 connected outer margin by extensive black, sometimes completely fused with outer margin; size formula: $C2 > C3 > C1$; spots rectangular, edged laterally by black, outer margin also edged by metallic black; basal area black. Fringe metallic gray. **Hindwing:** Metallic gray, paler proximally. Fringe metallic gray, whitish toward tornal area. **Abdomen** (Fig. 30): Metallic orange dorsally with basal tergite and posterior end metallic dark gray; metallic gray ventrally. Pleura of A8 somewhat square with elongate, slightly down-curved, pointed, distal process extending posteriorly and slender, straight, blunt-ended process extending anteriorly. **Genitalia:** As in Fig. 96 (drawn from EME slide 3707, San Luis Potosí; $n = 5$). Socii small, laterally flattened, not extending beyond posterior end of tegumen, base broad, attenuate into acute point distally. Tegumen with anterior end forming two lateral triangular processes. Saccus approximately 0.9 X tegumen length. Valva elongate, club-like with slender, short stalk at base. Phallus approximately 1.8 X longer than tegumen + saccus, basal half enlarged.

FEMALE. FW length 4.0-4.6 mm (4.21 ± 0.20 mm, $n = 8$). Color pattern as

described for male. **Genitalia:** As in Fig. 138 (drawn from YFH slide 0872, Texas, USNM; n = 3). Ventral bridge of apophyses anteriores very slender, with V-shaped distal end. Midventral notch of sternum at A7 wide, deep, extending to 1/3 of A7 length, prominent, flat, modified scales along both sides parallel to ventral branches of apophyses anteriores. Ductus bursae with funnel-like basal sclerite extending dorsally forming a round distal lobe with narrow, V-shaped, medial cleft. Signum short with blunt end, slightly down-curved.

TYPE MATERIAL: Holotype: ♀: U.S.A.: TEXAS: BOSQUE Co.: “28.X.” [no further data] (Belgrave, BMNH); lectotype of *Heliodines perichalca*, here designated: NEW MEXICO: 1♂, Las Vegas, VII.1903 (Meyrick Coll., BMNH).

3♂ paratypes examined: U.S.A.: TEXAS: BOSQUE Co.: 1♂, “27.VI” [no further data], 1♂, “7.VII” [no further data] (Belgrave, BMNH); NEW MEXICO: 1♂ (paralectotype of *Heliodines perichalca*, here designated), Las Vegas, VII.1903 (Meyrick Coll., BMNH, slide no. 9377).

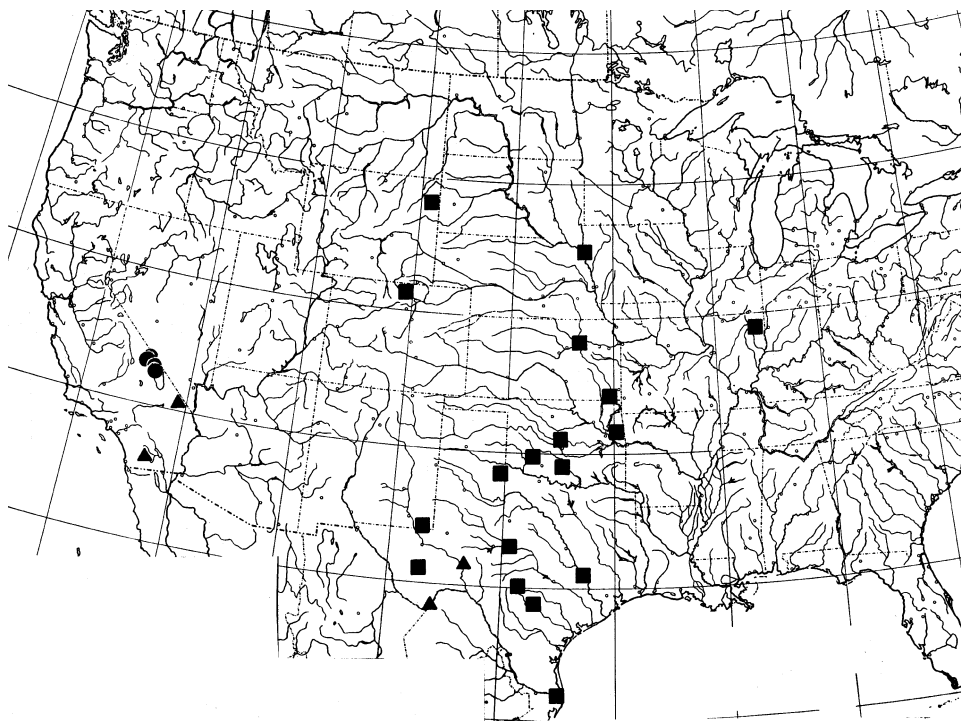

Fig. 22. Map of the United States showing distribution records for *Aetole cera* Hsu [circles], *A. favonia* Hsu [triangles], and *A. tripunctella* (Walsingham) [squares].

ADDITIONAL SPECIMENS EXAMINED: MEXICO: SAN LUIS POTOSÍ: 1♂, 37 mi S San Luis Potosí, 23.VIII.1981 (J. Chemsak, A., M. Michelbacher, UCB). U.S.A.: **COLORADO: LARIMER Co.:** 1♂, Ft. Collins, VI.1899 (LACM). **ILLINOIS: COLES Co.:** 1♂, Charleston, T12N, R9E, NW1/4, Sec. 11, 6.VI.1991, reared from *Mirabilis nyctaginea*, emgd. 25.VI.1991, 1♂, 12.VII.1992, reared from *M. nyctaginea*, emgd. 24.VII.1992, 1♀, 6.VI.1993, reared from *Mirabilis nyctaginea*, emgd. 16.VI.1993 (T. Harrison, UCB). **IOWA: WOODBURY Co.:** 1♂, 1♀, Sioux City, V.1927 (C. N. Ainslie, USNM). **KANSAS: RILEY Co.:** 1♀, Manhattan, VI.1930 (R. H. Painter, USNM). **LABETTE Co.:** 1♂, Oswego, 27.V.1961 (G. F. Hevel, USNM). **NEW MEXICO: EDDY Co.:** 1♂, 32°22.2'N, 103°47.4'W (site 4), malaise trap, 29.VII.1979 (D. R. Delorme, C. P. McHugh, TXAM). **OKLAHOMA: OKLAHOMA Co.:** 2♂, Oklahoma City, 1-4.IX.1954, 16♂, 2♀, 8.VII to 21.VIII.1955, 9♂, 1♀, 6.VII to 3.IX.1956 [some reared without host given] (all D. R. Davis, USNM). **SEQUOYAN Co.:** 2♂, 3 mi W Blackgum, Tenkiller Lake, 6-9.VII.1979; 1♂, 2 mi NW Blackgum, Tenkiller Lake, 25-29.VIII.1982 (both D. & M. Davis, USNM). **COMANCHE Co.:** 1♂, Wichita Mts., Nat'l. Wildlife Refuge, The Narrows, 10-18.VII.1984 (D. & M. Davis, USNM). **MURRAY Co.:** 1♂, Arbuckle Mts., 1 km W Turner Falls, 19-30.VII.1984 (D. & M. Davis, USNM). **TEXAS: [Bosque Co.]:** 1♂ (Belfrage, MCZ) [false "syntype" of *Aetola bella* Chambers; see discussion under *A. bella*]. **CAMERON Co.:** 1♀, Brownsville, 5.VI.1895 (Townsend, USNM). **BEXAR Co.:** 1♂, San Antonio, 18.IX.1942 (E. S. Ross, CAS); 2♂, 3 mi W Leon Vy., Mt. View acres, 25.VI.1972 (Powell, UCB). **BRAZOS Co.:** 1♀, College Station, Hensel Park, 19.X.1978 (T. P. Friedlander, TXAM). **BROWN Co.:** 1♂, Lake Brownwood Sta. Park, 8.VII.1967 (A. & M. E. Blanchard, USNM). **COTTLE Co.:** 1♂, Paducah, 9.VII.1967 (A. & M. E. Blanchard, USNM). **JEFF DAVIS Co.:** 1♂, Limpia Cyn., 20.V.1950 (E. C. Johnson, CNC). **KERR Co.:** 1♀, Kerrville, [no date], (F. C. Pratt, USNM). **WYOMING: WESTON Co.:** 1♂, 6 mi NW Newcastle, 13.VII.1965 (R. W. Hodges, USNM).

GEOGRAPHIC RANGE: (Fig. 22) U.S.A. (Colorado, Illinois, Iowa, Kansas, Oklahoma, Texas, Wyoming); Mexico (San Luis Potosí).

BIOLOGY: Harrison and Passoa (1995) reported that this species is a leaf miner on *Mirabilis nyctaginea* in Illinois.

Aetole unipunctella (Walsingham), new combination
(Figs. 23, 52, 97, 139, 172, 210)

Heliodines unipunctella Walsingham, 1892b: 385; Dyar, 1903: 537; Busck, 1910a: 183; Meyrick, 1913: 17 (name list), 1914b: 20; Heppner and Duckworth, 1983: 28 (checklist).

Heliodines metallicella Busck, 1909: 96, 1910a: 183; Meyrick, 1913: 17 (name list), 1914b: 20; Heppner and Duckworth, 1983: 28 (checklist). NEW SYNONYMY

MALE. FW length 3.4-5.4 mm (4.50 ± 0.64 mm, $n = 26$). **Head:** Frons, vertex, and antenna metallic dark gray. Scaling behind eyes brown, barely visible. Labial palpus metallic dark gray with white base. **Thorax:** Metallic dark gray tinged with bluish green, mesothorax with pleura covered by metallic orange patch. Legs metallic dark gray tinged with bluish green, with metallic black spots; single patch of metallic reddish orange on anterior black spot. Inner medial spur about 1.25 X longer than outer. Metacoxa with extensive metallic black posteriorly. **Forewing:** Metallic dark gray with two metallic scarlet, flame scarlet, or chrome orange patches, proximal patch a transverse band connecting costa and dorsum, approximately of uniform width; distal patch with linear proximal edge and sharply outward-curved distal edge, wider toward costa, outer margin in contact with costa, inner margin remote from dorsum in some specimens. Fringe metallic dark gray. **Hindwing:** Metallic very dark gray. Fringe metallic dark gray, basal portion white along dorsal margin, increasing toward tornus. **Abdomen** (Fig. 52): Metallic dark gray tinged with bluish green dorsally, lead-gray ventrally; medial portion scarlet, more extensive dorsally. Pleura of A8 square with digitate process curved downward, with acute tip extending posteriorly, and elongate, slender process extending anteriorly to A6, basal portion of arms of anterior processes fused, forming fork-like structure. **Genitalia:** As in Fig. 97 (drawn from EME slide 3713, Ariz., and YFH slide 0680, aedeagus, Ariz., CAS; $n = 4$). Socii small, slender, extending barely beyond posterior end of tegumen, distal end sharply pointed. Tegumen with anterior end forming two elongate lateral processes, posterior end bilobed, rounded. Saccus approximately 1.35 X longer than tegumen. Valva elongate, club-like with short, slender stalk at proximal base. Phallus elongate with pointed distal end, approximately 1.55 X longer than tegumen + saccus. Cornuti single, slender.

FEMALE. FW length 3.5-4.7 mm (4.00 ± 0.32 mm, $n = 21$). Color pattern as described for male. **Genitalia:** As in Fig. 139 (drawn from YFH slide 0880, USNM, Ariz.; $n = 6$). Ventral bridge of apophyses anteriores slender, forming V-shaped end. Midventral notch of sternum at A7 wide but shallow, reaching 0.25 of A7 length, lacking modified scales. Basal portion of ductus bursae strongly modified, forming heavily sclerotized tube with sharply pointed distal end protruding out of sinus vaginalis. Signum elongate, down-curved with blunt end, length variable.

TYPE MATERIAL: Holotype: ♂: **U.S.A.: CALIFORNIA: LOS ANGELES Co.:** Los Angeles [no further data] (Walsingham Coll., BMNH, slide no. 9376); **ARIZONA: COCONINO Co.:** 1 ♀ (holotype of *H. metallicella*), Williams, "21.7" [no further data] (H. S. Barber, USNM, type no. 12270).

ADDITIONAL SPECIMENS EXAMINED: MEXICO: BAJA CALIFORNIA SUR: 1 ♂, 1 ♀, 2 km S San Pedro, 600', at a wash, 9.XI.1993, reared from *Boerhavia coccinea*, emgd. 3-10.XII.1993, JAP 93L11 (Y.-F. Hsu, UCB); 3 ♂, 2 ♀, 2 km SE San Bartolo, 900', 10-11.XI.1993, reared from *B. coccinea*, JAP 93L15.1, 1 ♂, reared from

B. gracilima, emgd. 2.XII.1993, JAP 93L17, 1♀, reared from *B. spicata*, emgd. 8.XII.1993, JAP 93L18 (Hsu, UCB). **CHIAPAS**: 1♀, Suchiapa, 18.VII.1957 (P. D. Hurd, UCB); 1♂, 2 mi S Tuxtla Gutierrez, El Zapotal, 1.VIII.1957 (J. A. Chemsak, B. J. Rannells, UCB). **COAHUILA**: 1♂, 12 mi SE San Pedro de las Colonias, 26.IX.1976 (Powell, UCB). **COLIMA**: 1♂, Clarion I. [Revillagegedo Is.], 28.IV.1925 (H. H. Keifer, CAS). **MEXICO**: 1 specimen (abdomen missing), Teotihuacán Pyramid to the Sun, 27.XII.1970, at flowers of *Cassia tomentosa* (P. & M. Arnaud, CAS). **NAYARIT**: 1♂, 1♀, Ponitas, 27.III.1974 (E. Rogers, UCB). **PUEBLA**: 1♀, 7 km SE Morelos Canada, 5.VII.1974 (Chemsak, Powell, UCB); 1♂, 4.4 mi SW Acatepec, 9.VII.1981 (Bogar, Schaffner, Friedlander, TXAM); 4♂, 7 km W Tlacotepec, 1950 m, 23.VIII.1987 (J. W. Brown, Powell, UCB, BMNH). **SONORA**: 1♂, 1♀, 15 mi S Carbo, 27.IX.1977 (Chemsak, Michelbacher, UCB, BMNH); 2♂, 1♀, Guaymas, 8.IV.1979 (D. G. Denning, UCB). **VERACRUZ**: 2♂, Cotaxtla, Cotaxtla Exp. Sta., 23.VI.1962 (D. H. Janzen, UCB). **U.S.A.**: **ARIZONA**: **COCHISE Co.**: 1♀, 18 mi E Douglas, 5.IX.1958, on *Eriogonum abertianum neomexicanum* (P. D. Hurd, UCB). **COCONINO Co.**: 1♀, Oak Creek Cyn., 4800', 11.VIII.1965 (R. W. Poole, USNM). **MOHAVE Co.**: 1♂, 19 mi SE Wikieup, 13.IV.1986 (Powell, UCB); 2♂, 4♀, 5 mi SW Kingman, 2800', 21.VI.1993, reared from *Boerhavia coccinea*, emgd. 24.VI to 17.VII.1993, JAP 93F51 (Hsu, UCB). **PIMA Co.**: 1♂, 1♀, Sabino Cyn., on Sage, 2.XI.1921 (G. Hofer, USNM); 1♂, Baboquivari Mts, 15/30.VII.1924 (O. C. Poling, USNM), 1♂, [no date given] (F. H. Snow, MCZ); 1♀, 9 mi SE Tucson, 3.IX.1961, on *Bahia absinthifolia* (P. D. Hurd, UCB); 1♀, Tucson, 1230 East Placito del Cervato, 4.IX.1990, at light (R. S. Wielgus, UCONN). **SANTA CRUZ Co.**: 1♂, Santa Rita Mts., Madera Cyn., 4880', 5.IX.1959 (R. W. Hodges, USNM), 1♂, same locality, 8.XII.1962 (P. H. Arnaud, CAS). **YUMA Co.**: 1♂, 24.5 mi N Yuma, 11.V.1973, on *Larrea tridentata* (P. D. Hurd, E. G. & J. M. Linsley, A. E. & M. M. Michelbacher, UCB). **CALIFORNIA**: **RIVERSIDE Co.**: 1♀: Eagle Mountain Rd., NW Desert Center, 24.IX.1991 (T. M. Kuklensk, S. E. Miller, BPBM). **NEW MEXICO**: **DONA ANA Co.**: 2♂, 3 mi E Mesilla Park, 7.IX.1961 (P. D. Hurd, UCB). **TEXAS**: **BREWSTER Co.**: 1♀, SW Lajitas, 19.V.1959 (Howden, Becker, CNC). **UTAH**: **WASHINGTON Co.**: 1♀, Hurricane, 14.VI.1919 (T. Spalding, USNM).

GEOGRAPHIC RANGE: (Fig. 23) U.S.A. (Arizona, California, New Mexico, Texas); Mexico (Baja California Sur, Chiapas, Coahuila, Colima, Mexico, Nayarit, Puebla, Sonora, Veracruz).

BIOLOGY: The larval host plants are *Boerhavia coccinea* Mill. (Nyctaginaceae) in Arizona (JAP 93F51) and *B. coccinea* (JAP 93L11, 93L15.1), *B. gracilima* Heimerl (JAP 93L17), and *B. spicata* Choisy (JAP 93L18) in Baja California Sur. The larva is a leaf miner, and pupation occurs externally on leaves. This species is undoubtedly multivoltine, with records of adults in almost every month of the year. Adults have been recorded, presumably seeking nectar, at flowers of various unrelated plants, including *Eriogonum* (Polygonaceae) and *Bahia* (Asteraceae) in Arizona and *Cassia* (Fabaceae) in Mexico, in addition to *Boerhavia*.

PARASITISM: The following species have been reared from field-collected larvae of *A. unipunctella*: *Elasmus* sp. (Elasmidae) (JAP 93F51); *Chelonus* sp. (Braconidae) (JAP93L15.1); unidentified Microgasterinae species (Braconidae) (JAP 93F51, 93L11).

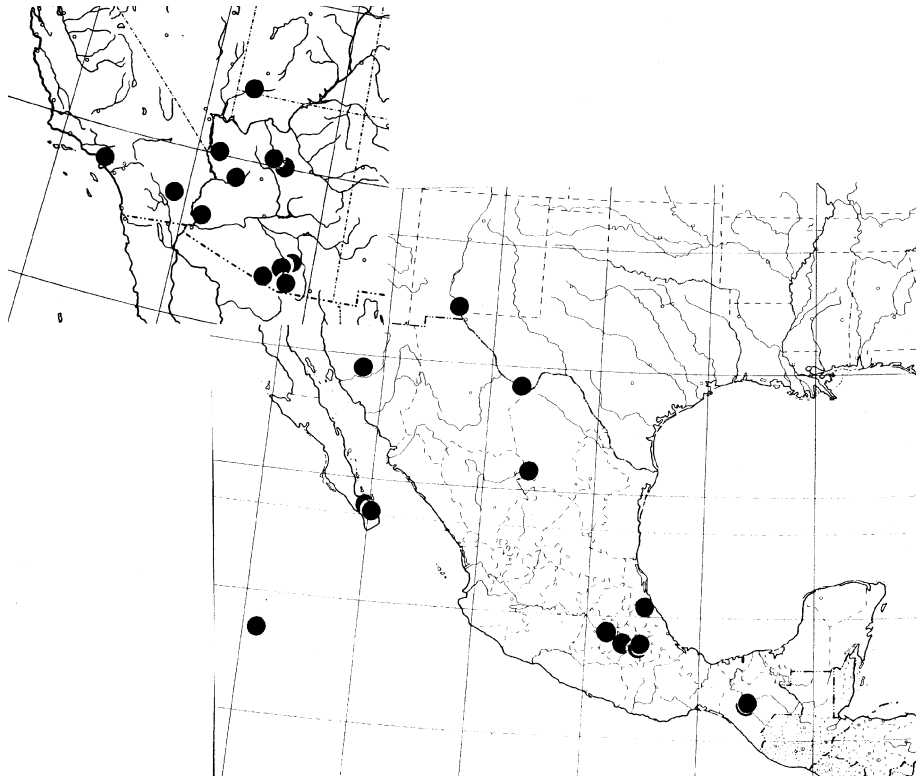

Fig. 23. Map of southwestern United States (upper left, slightly enlarged) and Mexico showing distribution records for *Aetole unipunctella* (Walsingham).

Aetole inusitata Hsu, new species
(Figs. 140, 211)

MALE. Unknown.

FEMALE. FW length 3.4 mm (n = 1). **Head:** Frons, vertex, and antenna metallic dark gray. Scaling behind eyes pale buff. Labial palpus metallic dark gray with basal half white. **Thorax:** Metallic dark gray tinged with greenish blue, pleura covered by metallic orange. Legs metallic dark gray. Spots on metatibia metallic black tinged with greenish blue; two additional metallic orange patches in front of anterior and medial black spots. Inner medial spur about 1.1 X longer than outer. Single metallic orange patch in the middle of mesotibia. Metacoxa covered with extensive metallic black; distal ends of procoxa, mesocoxa cream-white. **Forewing:** Metallic dark gray with two metallic chrome orange spots; proximal spot near base, irregularly shaped with proximal portion sharply attenuate, inner edge contacting dorsal margin, outer edge remote from costa; distal spot extended into a band reaching costa and dorsal margin, its proximal edge nearly linear, distal edge curved downward. Both spots edged by metallic black. A faint, metallic black patch distal to distal orange spot at costa. Fringe metallic dark gray. **Hindwing:** Metallic dark gray. Fringe metallic dark gray. **Abdomen:** Metallic orange dorsally with A1, A2, and distal end metallic dark gray; metallic pale gray, partially whitish in middle. Lateral, metallic chrome orange patches near distal end. **Genitalia:** As in Fig. 140 (drawn from holotype; n = 1). Ventral bridge of apophyses anteriores slender, forming V-shaped distal end. Midventral notch of sternum at A7 wide, deep, extending to 1/3 of A7 length; long, modified scales through both sides of inner edges of notch. Signum small, forming acute spine.

TYPE MATERIAL: Holotype: ♀: **MEXICO: BAJA CALIFORNIA SUR:** 2 mi SE San Bartolo, 900', 10/11.XI.1993, reared from *Commicarpus brandegeei* [Nyctaginaceae], emgd. 7.XII.1993, JAP 93L20 (Y.-F. Hsu, UCB).

GEOGRAPHIC RANGE: Mexico (Baja California Sur).

BIOLOGY: The larva is a leaf miner in *Commicarpus brandegeei* Standley (Nyctaginaceae) (JAP 93L20). Pupation occurs outside of the mine.

PARASITISM: The following has been reared from field-collected larvae of *A. inusitata*: unidentified Microgasterinae species (Braconidae)(JAP 93L20).

ETYMOLOGY: An adjective of Latin origin, *inusitata* = rare.

Aetole aprica Hsu, new species
(Figs. 98, 212)

MALE. FW length 4.5 mm (n = 2). **Head:** Frons, vertex, labial palpus, and antenna metallic gray. **Thorax:** Metallic gray, pleura covered by metallic chrome orange. Legs metallic gray; metacoxa with medial, metallic black patch. Spots on metatibia metallic black. **Forewing:** Metallic chrome orange with broad metallic gray outer margin covering 1/2 of forewing. Extensive metallic gray basal area. A transverse metallic gray band at about 1/4 from base. A costal metallic gray spot at about 1/2, sometimes fused with outer margin. Band, spot, and outer margin all edged by black. **Hindwing:** Metallic gray. Fringe metallic gray. **Abdomen:** Metallic chrome orange dorsally, metallic gray ventrally with black hair tuft near distal end dorsally. Pleura of A8 somewhat square with slender, straight, long, pointed process. **Genitalia:** As in Fig. 98 (drawn from photo, Holotype slide 27930, BMNH; n = 1). Socii swollen at base with distal half digitate, ending with blunt distal tip, distal end in contact with posterior end of tegumen, approximately 0.3 X tegumen length. Saccus as long as tegumen. Valva elongate, slightly laterally flattened, with blunt distal end. Phallus 1.3 X longer than tegumen + saccus, distal 2/3 with heavily sclerotized vesica.

FEMALE. Unknown.

TYPE MATERIAL: Holotype: ♂: U.S.A.: TEXAS: JEFF DAVIS Co.: Fort Davis, 5000', X.1927 (Meyrick coll., BMNH). 1 ♂ paratype: same data as holotype.

ETYMOLOGY: An adjective of Latin origin, *apricus* = sunny, exposed to the sun.

Aetole cera Hsu, new species
(Figs. 22, 53, 99, 141, 156, 213)

MALE. FW length 3.2-4.5 mm (3.90 ± 0.32 mm, n = 30). **Head:** Frons and vertex metallic gray or silver. Scaling behind eyes cream-white, short, almost entirely hidden under eye and occipital scaling. Antenna metallic black. Labial palpus metallic gray to pale gray, white toward base. **Thorax:** Metallic gray or silver, pleura covered with metallic chrome orange patches. Legs metallic gray with coxae frequently white. Posterior area on metacoxa covered partially by metallic black. Spots on metatibia prominent, metallic black. Inner medial spur about 1.2 X longer than outer. **Forewing:** Metallic chrome orange or flame-scarlet with metallic gray or silver-white outer margin; 1 costal and 1 dorsal metallic gray or silvery white spot near middle of wing. A basal patch and transverse band, metallic gray or silvery white. Spots and band edged variably by black. Dorsal spot frequently fused with outer margin into a

continuous band. Apical and tornal ends of outer margin enlarged, frequently white. Fringe metallic gray. **Hindwing:** Metallic pale gray to dark gray. Fringe metallic gray with basal portion white along dorsal margin, the white increasing toward tornus. **Abdomen:** (Fig. 53) Metallic gray or silvery white with two metallic chrome orange lateral patches, metallic black unevenly on ventral surfaces, caudal end metallic black mixed with buff, sometimes completely cream-buff. Pleura of A8 nearly square with a slender, straight, posterior, sharply pointed process and a short anterior process stout at base, abruptly attenuate into blunt point, extending to 1/2 of A7 length. **Genitalia:** As in Fig. 99 (drawn from EME slide 3716, Death Vy., Calif.; n = 3). Socii stout, straight, elongate, cone-shaped. Tegumen with anterior end forming two triangular lobes, posterior end divided, forming a pair of laterally flattened down-curved lobes with blunt distal tips. Saccus stout, about as long as tegumen. Valva stout, elongate, twisted by middle with a slender short stalk at base, laterally flattened, distal end club-like. Phallus stout, slightly curved upward at distal end, approximately 1.7 X longer than tegumen + saccus. Vesica sclerotized apically.

FEMALE. FW length 2.8-4.4 mm (3.56 ± 0.35 mm, n = 30). Color pattern as described for male except pleura of A8 not modified. **Genitalia:** As in Fig. 141 (drawn from EME slide 3719, Death Vy., Calif.; n = 3). Ventral bridge of apophyses anteriores slender, forming V-shaped end. Midventral notch of A7 sternum wide, forming large depression extending 1/3 of A7 length, long, modified scales on posterior half of both inner edges of notch. Ductus bursae with funnel-like, basal sclerite extending dorsally, forming a round lobe without medial cleft. Signum elongate, broad at base, attenuate into a round tip, curved downward at distal 1/3.

TYPE MATERIAL: Holotype: ♂: **U.S.A.: CALIFORNIA: INYO Co.:** Death Valley, 18 mi S Badwater, 0' elev., 6.V.1993, reared from *Anulocaulis annulatus*, emgd. 27.V.1993, JAP 93E15 (Y.-F. Hsu, UCB).

82♂, 47♀ paratypes: **U.S.A.: INYO Co.:** 51♂, 33♀, same data as holotype, emgd. 10.V to 7.VI.1993, 20♂, 4♀, same data, adults associated with *Anulocaulis annulatus*; 1♂, Death Valley, 3.5 mi S Golden Canyon, 300' elev., 6.V.1993, assoc. *A. annulatus*, 4♀, 6.V.1993, reared from *A. annulatus*, emgd. 25-29.V.1993, JAP 93E16; 1♀, Death Valley, Devil's Cornfield, 0' elev., 6.V.1993, assoc. *A. annulatus*, 1♀, 6.V.1993, reared from *A. annulatus*, emgd. 10.V.1993, JAP 93E17; 2♂, 2 mi SW Stovepipe Wells, 320' elev., 6.V.1993, assoc. *A. annulatus*, 8♂, 4♀, 6.V.1993, reared from *A. annulatus*, emgd. 27.V to 9.VI.1993, JAP 93E18 (all Y.-F. Hsu, UCB, BMNH, USNM).

GEOGRAPHIC RANGE: (Fig. 22) U.S.A. (California).

BIOLOGY: The larva is a leaf miner in *Anulocaulis annulatus* (Cov.) Stanley (Nyctaginaceae) (JAP 93E15, 93E16, 93E17, 93E18, 94C72). Pupae were observed attached to the undersides of leaves in the field (JAP 93E17). This species evidently

has at least two generations a year because both larvae and moths were collected in May 1993, and the larvae produced moths in the same season.

PARASITISM: The following species were found parasitizing the larvae: *Conura* sp., *Haltichella* sp. (Chalcididae) (JAP 93E15).

ETYMOLOGY: A noun of Greek origin, *Ker* = the goddess of death, so named because this species inhabits Death Valley, the lowest, driest, hottest, and seemingly most uninhabitable region in North America, and the larvae feed on a plant that is endemic there.

Aetole favonia Hsu, new species
(Figs. 22, 54, 100, 142, 214)

MALE. FW length 3.7-5.1 mm (4.42 ± 0.55 mm, $n = 5$). **Head:** Frons and vertex metallic gray. Scaling behind eyes cream-white, nearly obscured exteriorly. Antenna metallic black. Labial palpus metallic gray, white near base. **Thorax:** Metallic gray, pleura covered with metallic chrome orange patches. Legs metallic gray, posterior area on metacoxa partially covered by metallic black. Spots on metatibia prominent, metallic black. Inner medial spur about 1.15 X longer than outer. **Forewing:** Metallic chrome orange with very broad metallic gray outer margin, extending more than 1/2 of wing length. A costal metallic gray spot near middle of forewing. A basal patch and transverse, metallic gray band; spots and band variably edged by black. Fringe metallic gray. **Hindwing:** Metallic very dark gray. Fringe metallic gray with basal portion white along dorsal margin, white increasing toward tornus. **Abdomen** (Fig. 54): Metallic gray with two lateral, metallic chrome orange patches, metallic black unevenly on ventral surfaces; distal end metallic pale gray. Pleura of A8 somewhat square with slender, straight, posterior process with sharply pointed distal tip, short anterior process stout at base, attenuate into blunt point, extending up to 1/2 of A7 length. **Genitalia:** As in Fig. 100 (drawn from EME slide 0723, San Diego Co., Calif.; $n = 3$). Socii comparatively broad, straight, elongate, cone-shaped. Tegumen with anterior end forming two triangular lobes, posterior end divided, forming a pair of laterally flattened, down-curved lobes with blunt distal tips, saccus slender, about as long as tegumen. Valva elongate, broad, twisted near middle, with slender, short stalk at base, laterally flattened with entire length approximately equally thick, distal end club-like. Phallus stout, slightly curved upward at distal end, approximately 1.5 X longer than tegumen + saccus.

FEMALE. FW length 3.2-4.0 mm (3.64 ± 0.41 mm, $n = 5$). As described for male except pleura of A8 unmodified. **Genitalia:** As in Fig. 142 (drawn from EME slide 3724, San Bernardino Co., Calif.; $n = 2$). Medial, sclerotized, band of apophyses anteriores slender, forming V-shaped end. Midventral notch of sternum at A7 wide but shallow, extending anteriorly only 1/4 of A7 length, nearly circular. Scales on

inner edges of notch very long and dense. Ductus bursae with funnel-like basal sclerite extending dorsally forming a round lobe with wide, V-shaped, medial cleft. Signum short, broad, blade-like, slightly curved downward with acute distal end.

TYPE MATERIAL: Holotype: ♂: **U.S.A.: CALIFORNIA: SAN BERNARDINO Co.:** 6 miles SE Mountain Pass [Ivanpah Mts. near Kokoweef Peak], 24.IV.1992, reared from *Mirabilis multiflora*, emgd. 10.V.1992, JAP 92D103 (Y.-F. Hsu, UCB).

5♂, 5♀ paratypes: **U.S.A.: CALIFORNIA: SAN BERNARDINO Co.:** 1♂, 2♀, same data as holotype, emgd. 13-26.V.1992, 1♂, same data, reared from *Mirabilis bigelovii*, emgd. 10.V.1992, JAP 92D102 (Hsu, UCB); **SAN DIEGO Co.:** 1♂, 3♀, 4 mi SE Scissors Crossing, 25.III.1992, reared from *M. bigelovii*, emgd. 20-27.IV.1992, JAP 92C104.1 (Hsu, UCB). **TEXAS: BREWSTER Co.:** 1♂, Big Bend Natl. Park, Hot Springs, 29.IV.1959 (M. R. MacKay, CNC). **CROCKETT Co.:** 1♂, 21 mi E Pecos Ranch on S-290, 17.VII.1974 (H. Greenbaum, FSCA).

GEOGRAPHIC RANGE: (Fig. 22) U.S.A. (California, Texas).

BIOLOGY: The larva is a leaf miner in *Mirabilis multiflora* (Torrey) A. Gray (Nyctaginaceae) (JAP D103) and *M. bigelovii* A. Gray (JAP 92C104.1, D102) in California.

ETYMOLOGY: A noun of Latin origin, *favonius* = west wind.

REMARKS: This species is closely related to *A. cera* but differs in having a medial cleft at the basal sclerite of the ductus bursae and the signum broader and not strongly curved downward. In addition, *A. favonia* and *A. cera* feed on different larval hosts: *A. favonia* on *Mirabilis* and *A. cera* on *Anulocaulis*.

Extraneella Group
(Figs. 24, 39, 50, 101, 143, 150, 152, 215)

Included species: *A. extraneella* (Walsingham, 1881).

DIAGNOSIS: Metatibia with 3 black spots on outer side. Posterior margin of A7 in female without a notch. Medial, ventral band of apophyses anteriores a rectangular transverse band. Tergum of A8 an enormous membranous sheet; pleura in male with heavily sclerotized, prominent ventral process anteriorly and dorsal process posteriorly.

Head: Scales behind eyes short, white, inconspicuous externally. Antenna approximately 0.67 FW length. **Thorax:** Metallic gray with a pleural metallic orange

patch. Three metallic black spots on outer surface of metatibia, one basal to medial spurs, one around apical spurs, another between the two. Scale tufts of mesotibia and metatibia broad, flat. **Forewing:** (Fig. 39) 10 veins; R4 stalked with R5. Ground color orange with metallic gray distal margin. **Hindwing:** 5 veins; Rs stalked with M1 proximally. **Abdomen** (Fig. 50): A8 of male with tergum forming a broad, membranous sheet, sternum modified elaborately, extended midventrally to a robust process with a blind, blunt end. Pleura of A8 heavily sclerotized, forming plates with slender, elongate ventral process extending anteriorly and robust, elongate, digitate, dorsal process extending posteriorly. A7 sternum modified in male, forming a large, elongate, medial process with blunt distal end. **Male genitalia** (Fig. 101): Tegumen divided dorsally into two symmetrical parts; vinculum modified laterally into elongate process extending anteriorly. Socii dorsally nearly in full contact with the ventral edge of tegumen. Bulbus ejaculatorius attenuate into a lanceolate tip, connected with phallobase subterminally; vesica heavily sclerotized into a sheath with cornuti in a cluster of bristles.

Female genitalia (Fig. 143): Ventral bridge of apophyses anteriores a rectangular transverse band. Apophyses anteriores shorter than posteriores. Ductus bursae much shorter than corpus bursae. Signum simple, an invaginated fin-like projection.

Larval hosts are Onagraceae (Order Myrtales).

Aetole extraneella (Walsingham), new combination
(Figs. 24, 39, 50, 101, 143, 150, 152, 215)

Heliodines extraneella Walsingham, 1881: 323; 1892b: 385; Dyar, 1903: 537; Busck, 1910a: 183; Meyrick, 1913: 17 (name list), 1914b: 20; Heppner and Duckworth, 1983: 28 (checklist).

MALE. FW length 2.8-4.1 mm (3.54 ± 0.28 mm, n = 30). **Head:** Frons and vertex metallic dark gray. Scaling behind eyes white. Antenna metallic black. Labial palpus metallic gray with base pale gray or white. **Thorax:** Metallic dark gray, two small metallic orange patches on pleura. Legs metallic gray. Spots on metatibia metallic black. Inner medial spur about 1.4 X longer than outer; distal ends of tarsomeres also showing tendency to black. **Forewing:** Metallic chrome orange with nearly linear metallic gray outer margin; 5 costal and 3 dorsal metallic gray spots; size formula: C2 > C3 > C4 > C5 > C1, with C5 variable, sometimes larger than C2; D3 > D1 > D2; C4, C5, D1, D3 often partially or completely white; D3 frequently fused into outer margin, D2 sometimes reduced or absent, and C2 and D1 sometimes fused into a transverse band. Spots variably edged by black. Fringe metallic gray. **Hindwing:** Metallic pale gray. Fringe metallic gray with basal portion frequently buff-yellow or cream-white near tornus. **Abdomen:** Metallic gray. Pleura of A8 diamond-shaped, posteriorly with elongate process, curved downward and ending with sharp tip,

anteriorly with long, straight, rod-like process ending with blunt tip, extending beyond A7, anterior part sometimes bent laterally. **Genitalia:** As in Fig. 101 (drawn from EME slides 4162 and 3735 aedeagus, San Mateo Co., Calif.; n = 13). Socii small, stout, horn-like, distal end not extending beyond posterior end of tegumen. Tegumen with anterior end forming two rod-like processes, posterior end forming two lobes, curved upward, stout anteriorly then tapering into downward curved, blunt, distal ends. Saccus approximately 1.5 X tegumen length. Valva broad, simple, elongate, bent inward with round distal end; slender stalk at base. Phallus short, posterior half heavily sclerotized, approximately 1.4 X tegumen + saccus.

FEMALE. FW length 2.8-4.2 mm (3.58 ± 0.28 mm, n = 30). As described for male except A7, A8 not modified. **Genitalia:** As in Fig. 143 (drawn from EME slide 3807, San Mateo Co., Calif.; n = 12). Ventral bridge of apophyses anteriores broad, weakly sclerotized. No modification around ostium bursae. Ductus bursae extremely short. Signum large, straight, triangular with pointed distal end.

TYPE MATERIAL: Holotype: ♂: **U.S.A.: CALIFORNIA: SHASTA Co.:** Pitt [= Pit] River, 21-26.VII.1871 (Walsingham, BMNH, slide no. 9380). Paratypes Examined: 5♂, same data as holotype (BMNH, USNM).

ADDITIONAL SPECIMENS EXAMINED: CANADA: BRITISH COLUMBIA: 1♂, Hope Mts., 6000', 2.VIII.1932 (A. N. Gartrell, CNC). **U.S.A.: CALIFORNIA: ALAMEDA Co.:** 1♂, 17.VIII.[19]12 (USNM), 1♂, VIII.1912 (USNM); 1♀, Berkeley, 17.IV.1962 (S. Earnshaw, UCB); 1♂, Patterson Reserve, Del Valle Lake, 20.VIII.1973 (Powell, UCB); 1♀, Fairmont Ridge, SE San Leandro, 31.VIII.1989 (Powell, UCB). **CONTRA COSTA Co.:** 1♀, Antioch, 24.IV.1959 (C. W. O'Brien, UCB); 1♂, Antioch Natl. Wildlife Refuge, 17.IX.1981, on *Grindelia camporum* (Powell, UCB); 1♂, 1♀, Morgan Territory Regional Reserve, 1800-1850', 18.IX.1993 (M. E. McIntosh, UCB), 1♂, 3♀, same locality, 25.IX.1993, assoc. *Epilobium brachycarpum* (Hsu, UCB); 2♂, 2♀, Mt. Diablo, Russelmann Park, 14.VI.1960 (D. C. Rentz, CAS); 1♂, Pt. Molate, 15.IX.1994 (Powell, UCB); 1♀, Richmond Field Sta., 7.IV.1992, 2♀, 18.IX.1992 (Powell, UCB), 12♂, 3♀, 10.X.1992 (Powell, Hsu, UCB), 1♂ 19.IX.1992 and 1♀, reared from *Epilobium brachycarpum*, emgd. 4.X.1992, JAP 92J37.2, 5♂, 8♀, 13.IX.1993, reared from *E. brachycarpum*, emgd. 3/12.X.1993, 93J7, 1♀, 16.IX.1994, reared from *E. brachycarpum*, emgd. 10.X.1994 (all Hsu, UCB); 1♀, Round Top Peak, 28.VI.1986 (Powell, UCB). **EL DORADO Co.:** 1♂, 1♀, nr. Camino, Webber Cr., 25.VI.1960 (D. D. Linsdale, UCB). **HUMBOLDT Co.:** 1♂, 4♀, Larabee Valley, 3.IX.1933 (B. P. Bliven, CAS); 1♂, Bridgeville, 21.VII.1935 (B. P. Bliven, CAS). **KERN Co.:** 1♂, Kern Natl. Wildlife Refuge, 3-4.VI.1993, reared from *Epilobium pygmaeum*, emgd. by 24.VI.1993, JAP 93F1 (Hsu, UCB). **MARIN Co.:** 1♀, Cypress Ridge, 29.IV.1961 (D. C. Rentz, CAS); 1♂, 3 mi W Fairfax, 13.V.1966 (A. J. Slater, UCB); 1♂, nr. Tiburon, Ring Mt., 28.III.1984 (Powell, D. D. Murphy, UCB); 3♂, 1 mi SE Corte Madera, Ring Mtn., 30.IV.1986 (Powell, UCB); 1♂, 5 mi NE Nicasio, 3.IV.1986 (Powell, UCB).

MENDOCINO Co.: 2♂, 8♀, 7 mi W Eel River Rgr. Sta., 1450', 12.VI.1972, on *Achillea millefolium*, (Powell, J. T. Doyen, J. A. Chemsak, UCB); 2♂, 1♀, 2.5 air mi N Eel River Rgr. Sta., 14.VI.1972 (Chemsak, UCB); 2♂, 1♀, 4 air mi N Eel River Rgr. Sta., Ham Pass, 4400', 15.VI.1972 (Powell, UCB); 3♀, Eel River Rgr. Sta., Mendocino Forest Sta., 13.VI.1972, on *Aesculus californica* (Powell, UCB); 1♀, 2.5 air mi NW Eel River Rgr. Sta., Ham Pass Rd., 4400', 13.VI.1972 (J. T. Doyen, UCB); 1♂, 2 mi SE Piercy, 23.V.1976 (Powell, UCB); 2♀, 5 mi N Branscomb, Northern California Coast Range Pres., 25.V.1976 (Powell, UCB). **NAPA Co.:** 2♂, 3♀, nr. Monticello Dam, 16.VIII.1962, on flowers of *Eriophyllum lanatum* var. *achillaeoides* (Powell, UCB); 1♀, 7 mi E Conn Dam, 12.VI.1964 (Chemsak, UCB); 1♀, Mt. St. Helena, 24.VII.1967 (D.C. Rentz, UCB); 1♀, 5 mi E Pope Valley, 26.V.1968 (W. Gagne, UCB). **NEVADA Co.:** 2♂, 5 mi SW Grass Valley, Wolf Mt., 2200-2500', 7.V.1980 (Powell, UCB). **"PLACER Co." [El Dorado Co.]:** 1♀, Plummer Ridge, 26.VII.1972, on *Abies concolor* (E. Schlinger, UCB). **PLUMAS Co.:** 1♀, 7 mi N Loyaltan, Dyson Ln., 18.VIII.1963 (W. Turner, UCB); 1♂, Thompson Creek, 4 mi SE Quincy, 5300', 15.V.1982 (Powell, UCB); 1♀, Thompson Cr., 1 mi S Quincy, 13.IX.1983 (Chemsak, UCB). **SACRAMENTO Co.:** 1♂, 1♀ (+ 2 abdomen missing), Citrus Heights, 14.VI.1967, 1♂, 1♀ (+ 1 abdomen missing), 20.VII.1967 (all G. J. & A. D. Keuter, CAS). **SAN MATEO Co.:** 3♂, 2♀, Black Mountain Rd. (South), 13.IV.1985, 3♂, 27.IV.1985 (D. D. Murphy, UCB); 4♂, Edgewood Road at Highway 280 [= Edgewood Park, 'A'], 5.IV.1985 (Powell, Murphy, J. Brown, UCB, SDNHM); 3♂, 1♀, Edgewood Park, 26.IV.1990, 1♂, Edgewood Park, 'B', 11.V.1990, 1♂, 1♀, 28.IV.1991, 5♂ 3♀, 14.V.1991, 1♀, 1.VI.1991 (all Hsu, Powell, UCB); 1♀, 5.V.1992, 2♂, 23.VIII.1992, reared from *Epilobium densiflorum*, emgd. 17.IX.1992, JAP 92H30, 1♂, 15.IX.1992, reared from *E. densiflorum*, emgd. 18.IX.1992, JAP 92J34; 1♀, 24.IV.1993, reared from *Clarkia* sp., emgd. 12.V.1993, JAP 93D32, 4♂, 1♀, associated with *E. densiflorum*, 18.IX.1993, 1♂, 3♀, 18.IX.1993, reared from *E. brachycarpum*, emgd. 4/15.X.1993, JAP 93J9, 15♂, 18♀, 18.IX.1993, reared from *E. densiflorum*, emgd. 19.IX to 12.X.1993, JAP 93J11, 4♂, 8♀, 30.IX.1993, reared from *E. densiflorum*, emgd. 4-20.X.1993, JAP 93J41 (all Hsu, UCB, BMNH); 1♂, 1♀, Edgewood Park, 'D', 28.IV.1991, 2♂, 14.V.1991; 1♂, Jasper Ridge, SW Woodside, 5.IV.1985 (Powell, Murphy, Brown, UCB); 1♂, Jct. of Hwy. 92 and 280, 26.IV.1990 (Powell, UCB). **SANTA CLARA Co.:** 3♂, 1♀, 1.5 mi S Del Puerto Canyon Rd., San Antonio Vy., 14.IX.1971 (Powell, UCB); 1♀, Kirby Canyon Ridge, NW Anderson Dam, 9.IV.1986 (Murphy, P. Opler, Powell, UCB); 1♂, 2 km NW Coyote, Tulare Hill, 9.IV.1986 (Murphy, Opler, Powell, UCB); 1♂, Jackson Heights, S Kirby Cyn., 10.IV.1990

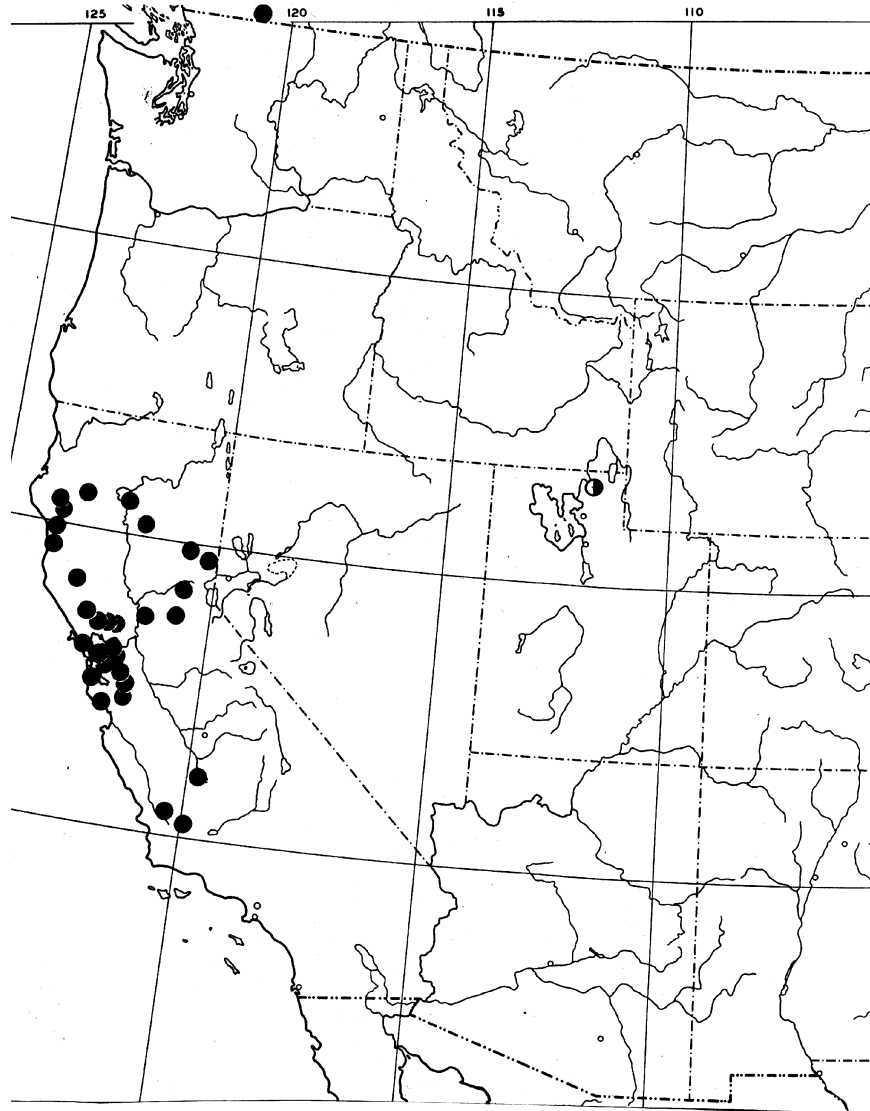

Fig. 24. Map of western United States showing distribution records for *Aetole extraneella* (Walsingham); half-open circle = Provo, Utah record (Braun 1925), specimen not examined.

(Murphy, A. E. Launer, UCB); 1♂, 3♀, Hale Hills N of Morgan Hill, 11.IV.1990; 1♂, Kalana Hills N of Morgan Hill, 11.IV.1990 (Hsu, Launer, Powell, UCB). **SANTA CRUZ Co.:** 1♂, 3♀, 4 mi E Boulder Cr., 11.VIII.1962, on flowers of *Anthemis cotula* (Powell, UCB). **SAN LUIS OBISPO Co.:** 1♀, La Panza Camp, 25.IV.1968, on *Eriophyllum lanatum* (Chemsak, Powell, UCB); 1♂, 6 mi SE Creston, 28.IV.1968, on *Achillea* (Chemsak, UCB). **TEHAMA Co.:** 1♂, 1♀, 6 mi N Paynes

Cr., IV.19.1960 (Opler, UCB). **TRINITY Co.:** 1 ♀, Indian Dick Sta., 16.VI.1972, on *Brodiaea hyacinthina* (Powell, UCB); 1 ♂, Hayfork, 2300', 18.V.1973 (Chemsak, UCB); 1 ♀, 7 air mi SW Hayfork, 4000', 24.V.1973, on flowers of *Gilia capitata* (J. T. Doyen, UCB). **YOLO Co.:** 2 ♀, Putah Cr. nr. Monticello Dam, 20.IX.1992, sweeping *Zauschneria* [= *Epilobium canum*], 2 ♂, 12.IX.1993 (Powell, UCB); 2 ♂, 3 ♀, Putah Cr., 3 mi E Monticello Dam, 3.IX.1993, reared from *E. canum*, emgd. 12-29.IX.1993, JAP 93J1 (Hsu, UCB); 1 ♂, 5 mi W Winters, 16.VIII.1962 (Powell, UCB). **UTAH: JUAB Co.:** 1 ♂, Mills, 10.VII.1989 (G. F. Knowlton, USNM).

GEOGRAPHIC RANGE: (Fig. 24) Canada (British Columbia); U.S.A. (California, Utah).

BIOLOGY: The larval hosts are Onagraceae: *Clarkia* sp. (JAP 93D32), *Epilobium* (*E.*) *brachycarpum* C. Presl. (JAP 93J7, 93J9), *E. (Boisduvalia) densiflorum* (Lindley) P. Hoch and Raven (JAP 92H30, 92J34, 93J11, 93J41), *E. (B.) pygmaeum* (Speg.) P. Hoch and Raven (JAP 93F1), and *E. (Zauschneria) canum* (E. Greene) Raven (JAP 93J1) in California, and *Gaura neomexicana* Wootton in Utah (Braun 1925) [we did not examine voucher specimens to confirm the identity of Braun's *extraneella*]. Ova are laid singly in crevices between young leaves or buds and stems and sometimes also on stems or young seed pods on *E. brachycarpum* in lab conditions (JAP 92K9). We found eggs on undersides of leaves on *E. densiflorum* in the field (JAP 93J11). The larva is a leaf miner but sometimes also bores into young seed pods. Pupation occurs on the host, outside of the mine. Overwintering takes place as small larvae in hibernacula spun in debris (JAP 92K7).

This species has at least two generations a year in central coastal California, with peak abundance of adults in the fall; it is likely populations build up during the season until cold weather or increased populations of parasitoids suppress them. The adults often visit unrelated plants for nectar, especially Asteraceae (e.g., *Achillea*, *Anthemis*, *Eriophyllum*, *Grindelia*), and for many years this led us to suspect the wrong plants in larval searches. This is the only heliodinid known to feed on Onagraceae.

PARASITISM: The following species have been reared from larvae of *A. extraneella*: *Agathis* sp., *Hormius* sp. (Braconidae) (JAP 93J11), *Gonatocerus* (Mymaridae)(JAP 93J7); *Pnigalio* sp. (Eulophidae)(JAP 93J7); *Elasmus* sp. (Elasmidae)(JAP 93J7).

Calcifer Group

(Figs. 25, 40, 55, 102-103, 144-145, 216-217)

Included species: *A. calcifer* (Walsingham, 1909), new combination; *A. calciferoides* Hsu, new species.

DIAGNOSIS: Meso- and metatibia with prominent scale tuft. Pleura of A8 in male developed as a pair of semicircular lobes. Aedeagus with prominent dorsal hook distally. Lamella postvaginalis with a pair of small oval sclerites.

Head: Scales behind eyes linear, short. Antenna as long as FW. **Thorax:** Metallic gray tinged with green. Pleura covered with metallic pale orange. Metatibia roughly scaled. Inner medial spur less than 1.2 X longer than outer. Scale tufts of mesotibia, metatibia prominent, bristle-like. **Forewing:** (Fig. 40) 10 veins, all separate. Ground color bright orange with a metallic black and silver distal margin; several costal and dorsal metallic spots. **Hindwing:** 5 veins, all separate. **Abdomen** (Fig. 55): A8 of male with tergum reduced to a small sclerotized lobe. Pleura forming semicircular, sclerotized lobes. **Male genitalia** (Figs. 102-103): Tegumen divided into two symmetrical parts, elongate, pointed distally. Socii elongate, partially setose. Saccus thickened, with a club of irregular shape at distal end. Valva broad, setaceous on inner wall. Aedeagus with dorsal hook distally. Bulbus ejaculatorius joining with phallobase terminally. Cornuti oval, in form of a cluster of spines. **Female genitalia** (Figs. 144-145): Ventral bridge of apophyses posteriores somewhat triangular. Apophyses posteriores with enlarged, truncate anterior end, much longer than anteriores. Lamella postvaginalis forming a pair of oval sclerites invaginated posteriorly. Ductus bursae shorter than corpus bursae. Signum an invaginated, fin-like projection. Larval hosts unknown.

KEY TO SPECIES OF THE CALCIFER GROUP OF *Aetole*

- Spurs of metatibia with brush-like hair tufts. Socii skittle (bowling pin)-shaped. Signum narrow, more than 6 X longer than wide *calcifer*
Spurs of metatibia lacking hair tufts. Socii elongate with distal tips curved downward. Signum broad, less than 5 X longer than wide *calciferoides*

Aetole calcifer (Walsingham), new combination
(Figs. 25, 40, 55, 102, 144, 216)

Scelorthus calcifer Walsingham, 1909: 2.

Scelorthus calcifera Meyrick, 1913: 17 (name list), invalid emend., 1914b: 18;
Heppner and Duckworth, 1983: 27 (checklist); Heppner, 1984: 57, (checklist).

MALE. FW length 4.2-5.6 mm (4.91 ± 0.39 mm, n = 30). **Head:** Coloration variable, with frons, vertex, and hood-like scales posterior to vertex metallic gray, metallic gray mottled with spectrum orange, or mostly metallic spectrum orange. Antenna metallic gray. Labial palpus white, metallic gray apically. **Thorax:** Metallic gray mottled with metallic spectrum orange dorsally to various extent, especially on patagia and tegulae; pleura variegated with metallic gray, dark gray, pale yellow, and

spectrum orange. Legs metallic dark gray. Prothoracic coxa, tibia, and 1st tarsomere sometimes with trace of pale yellow. Mesothoracic tibia and 1st tarsomere with extensive metallic yellow-orange on outer surface. Metatibia with two prominent metallic spectrum orange patches on outer surface, one metallic gray streak at proximal end. Prominent metallic dark gray mottled with gray hair tufts around spurs. Spurs with brush of hairlike scales along posterior edge. Metallic spectrum orange also on outer surface of 1st, 2nd, and 3rd metathoracic tarsomeres. Inner medial spur of metatibia approximately 1.1 X longer than outer. **Forewing:** Ground color metallic spectrum orange or chrome orange with narrow, metallic gray outer margin; 2 costal and 2 dorsal square or rectangular metallic gray spots. All spots nearly equal in size and edged by black. Outer margin edged by black proximally. A metallic gray or very dark gray basal patch, extensive in some specimens. Prominent metallic black shade in the middle of wing, connecting all spots and both ends of outer margin. Fringe metallic gray. **Hindwing:** Metallic fuscous, dark gray distally, spectrum orange proximally. Fringe metallic gray, fuscous along dorsum, pale yellow near tornus. **Abdomen:** Metallic flame-scarlet dorsally, metallic cream-yellow or metallic black banded with gray ventrally. Caudal end metallic dark gray. Lateral dull scarlet hair tufts from A4 to A7, with those on A6 and A7 most prominent. **Genitalia:** As in Fig. 102 (drawn from EME slides 3747, Jalisco, and 3753, aedeagus, Oaxaca; n = 11). Tegumen consisting of a pair of symmetrical, triangular, pointed pieces, closely adjacent along medial line. Socii very large, elliptic with blunt tip and broad basal stem, densely setose with large spine-like setae ventrally. Valva with no basal stalk, densely setose on inner wall distally, enlarged at base with distal half forming triangular dorsal lobe. Posterior end of vinculum forming deep V-shaped cleft. Saccus thick with a club of irregular shape at distal end, approximately 1.7 X tegumen length. Phallus approximately 1.4 X tegumen + saccus. Aedeagus forming a prominent dorsal beak at distal end. Cornuti a cluster of spines concentrated in an oval area subterminally.

FEMALE. FW length 4.2-5.9 mm (5.07 ± 0.45 mm, n = 30). Color pattern as described for male. Lateral tufts on abdomen greatly reduced. **Genitalia:** As in Fig. 144 (drawn from EME slide 3752, Jalisco; n = 4). Ventral bridge of apophyses anteriores triangular with acute posterior end. Sterigma forming a broad funnel. Signum elongate, strongly curved with obtuse terminal end.

TYPE MATERIAL: Holotype: ♂: **MEXICO: MORELOS:** Cuernavaca, 18.VI. [no year given], Gdm. Slvn. 65999, Wlsm Coll. 1910-427 (H. H. Smith, BMNH, slide 9374). 1 ♂ paratype: **MEXICO: GUERRERO:** 2000 ft, Tierra Colorada, Gdm, Slvn. 66000, Wlsm Coll. 3357 (H. H. Smith, USNM).

ADDITIONAL SPECIMENS EXAMINED: MEXICO: GUERRERO: 1 ♂, Acapulco, 100', 6.VIII.1954 (J. G. Chillcott, CNC); 1 ♂, 2 km S Xalitla, 25.VII.1983 (J. A. Chemsak, A., M. Michelbacher, UCB). **JALISCO:** 13 ♂, 2 ♀ [mated pair],

Puente Barranquitas, 14 [airline] mi [= 18 road mi.] NW Magdalena, 3000', 10.X.1975 [*Ipomoea* assoc.] (Powell, Chemsak, UCB); 2♀, Chamela, Est. Biol. 20-27.VII.1984 (J. T. Doyen, UCB); 1♂, 23-31.VII.1990 (Chemsak, UCB); 3♂, 11 km N Melaque, 28.VII.1984 (Chemsak, UCB). **NAYARIT**: 2♂, 3♀, San Blas, 25.VI.1956 (W. McDonald, LACM); 1♂, 60 mi N Tepic, 15.VIII.1957 (Chemsak, B. J. Rannels, UCB); 4♂, 5♀, Huajicori Riv., 28.VII.1984 (Bloomfield, Faulkner, SDNHM); 7♂, 1 mi S Acaponeta, 11.X.1975 (Powell, Chemsak, T. Friedlander, UCB). **OAXACA**: 1♂, Jalapa del Marques, 28.VII.1962 (A. E. Michelbacher, UCB); 1♂, 4♀, 38 mi NW Tehuantepec, 19.VIII.1963 (Scullen, Bolinger, USNM); 1♂, 2♀, 29 mi NW Tehuantepec, 11.VIII.1974 (C. W. & L. O'Brien, Marshall, UCB); 3♂, 4♀, 10.4 mi W Tehuantepec, 4.VIII.1980 (Schaffner, Weaver, Friedlander, TXAM); 6♂, 5♀, 29 km SE Oaxaca, Ruinas Yagul, 13.VIII.1988 (J. Doyen, S. Stockwell, UCB); 1♂, 5 km NW Rincon Bamba, 14.VII.1990, on *Lysiloma divaricata* (T. Eager, P. G. de Silva, UCB). **PUEBLA**: 1♀, River E Tepexco, 1250 m, Hwy. 100, 24.VIII.1977 (E. I. Schlinger, UCB). **SINALOA**: 1♂, 1♀, 26 mi N Pericos, 13.VIII.1960 (P. Arnaud, Jr., E. S. Ross, D. C. Rentz, CAS); 2♀, 18 mi S Guamuchil, 7.VIII.1964, on *Croton culicanensis* (Powell, UCB); 1♂, 4♀, 26.IX.1977 (Chemsak, A. & M. Michelbacher, UCB); 1♂, 17 mi S Guamuchil, 7.VIII.1966 (Doyen, Chemsak, UCB); 5♂, 4♀, 13.VIII.1981 (Chemsak, Michelbacher, UCB); 1♀, 6.2 mi W Badiraguato, 260 m, 17.IX.1977 (E. I. Schlinger, UCB); 1♂, 21 mi S Culiacan, 13.VIII.1981 (Chemsak, Michelbacher, UCB); 1♀, 6 mi N Elota, 13.VIII.1981 (Chemsak, Michelbacher, UCB); 1♀, 2 km SW Sta. Lucia, 6.VIII.1986, black light trap (J. W. Brown, Powell, UCB). **SONORA**: 1♂, 4♀, Alamos, 12.VIII.1960 (P. H. Arnaud, Jr., E. S. Ross, D. C. Rentz, CAS); 1♂, same locality 1000' (Trailer Park), 21.VIII.1964 (D. C. & K. A. Rentz, J. A. Grant, CAS); 3♂, 1♀, 3 mi W Minas Nuevas, 450 m, nr. Alamos, 17.IX.1977, Malaise trap (Schlinger, UCB).

GEOGRAPHIC RANGE: (Fig. 25) Mexico (Guerrero, Jalisco, Morelos, Nayarit, Oaxaca, Puebla, Sinaloa).

BIOLOGY: Adults have been found at flowers of *Croton* (Euphorbiaceae), *Lysiloma* (Fabaceae), and *Ipomoea* (Convolvulaceae) in Mexico, but none of these is likely to be a larval host plant.

Aetole calciferoides Hsu, new species
(Figs. 25, 103, 145, 217)

MALE. FW length 3.9-4.6 mm (4.11 ± 0.21 mm, n = 9). **Head:** Frons, vertex,

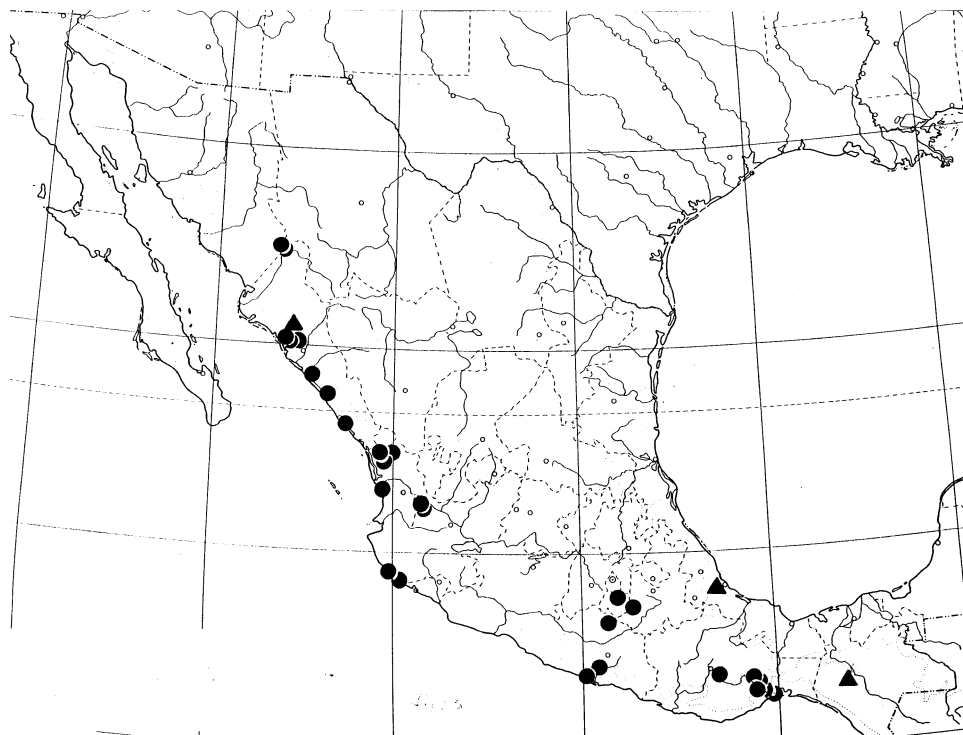

Fig. 25. Map of Mexico showing distribution records for *Aetole calcifer* (Walsingham) [circles] and *A. calciferoides* Hsu [triangles].

and hood-like scales posterior to vertex metallic dark gray mottled with metallic spectrum orange. Scaling behind eyes white. Antenna metallic dark gray. Labial palpus white with metallic dark gray tip. **Thorax:** Metallic dark gray mottled with metallic chrome orange. Two prominent, linear, small, orange or cream-white patches at posterior edge proximal to tegulae dorsally. Pleura with yellow-orange. Legs metallic dark gray, with coxae extensively covered by metallic chrome orange or yellow-orange. Prothoracic tibia, and 1st tarsomere with trace of metallic chrome orange. Mesothoracic tibia and

1st tarsomere with extensive metallic spectrum orange on outer surface. Metathoracic tibia with two prominent, metallic spectrum orange patches on outer surface; a metallic gray dorsal streak at proximal end. Metallic black or deep gray, with paler gray hair tufts around spurs. Spurs without brush of hairlike scales. Metallic spectrum orange or yellow-orange ventral patch proximally on each metatarsus. Inner medial spur of metatibia approximately 1.1 X longer than outer. **Forewing:** Metallic chrome orange with narrow metallic gray outer margin; 3 costal and 3 dorsal square, subequal, metallic gray spots, edged with black; C3 and D3 fused into gray outer margin in some specimens. Basal area fuscous. Variable shadow of fuscous at center of wing, in some specimens extensive. Fringe metallic gray. **Hindwing:** Metallic tawny, tinged

with orange. Fringe metallic gray, orange toward tornus. **Abdomen:** Metallic orange dorsally, cream-white ventrally with scattered black laterally. Distal end cream-white. Lateral dull scarlet hair tufts from A4 to A7, with those on A6 and A7 most prominent. **Genitalia:** As in Fig. 103 (drawn from EME slide 3745, Veracruz, Mex.; n = 4). Tegumen deeply divided, forming two elongate, lanceolate processes distally; basal portion enlarged, tapering into obtuse distal end. Socii broad, elongate with distal tip curved downward. Saccus very long with folded distal end. Valva reniform, elongate, evenly setose, laterally flattened, curved upward with obtuse distal end. Phallus approximately 1.25 X tegumen + saccus. Aedeagus with distal end protruding dorsally into a short, hooked process. Cornuti a cluster of slender spines concentrated in an oblong area.

FEMALE. FW length 3.9-4.3 mm (4.05 ± 0.17 mm, n = 4). Color pattern as described for male. **Genitalia:** As in Fig. 145 (drawn from EME slide 3744, Sinaloa, Mex.; n = 4). Ventral bridge of apophyses anteriores triangular with obtuse distal end. Signum elongate, broad, strongly curved downward with obtuse distal end.

TYPE MATERIAL: Holotype: ♂: **MEXICO: VERACRUZ:** 6 mi SE Rinconada, Puente Nacional, 30.IX.1975 (J. Chemsak, J. Powell, T. Eichlin, and T. Friedlander, UCB).

8♂, 4♀ paratypes: **MEXICO: CHIAPAS:** 1♂, Suchiapa, 18.VII.1957 (Chemsak, B. J. Rannells, UCB). **SINALOA:** 3♂, 4♀, 18 mi S Guamuchil, 26.IX.1977, (Chemsak, Michelbacher, UCB), 2♂, 17 mi S Gumauchil, 13.VIII.1981 (Chemsak, Michelbacher, UCB). **VERACRUZ:** 2♂, same data as holotype.

GEOGRAPHIC RANGE: (Fig. 25) Mexico (Chiapas, Sinaloa, Veracruz).

ETYMOLOGY: This species is so named because it is superficially extremely similar to *Aetole calcifer* (Walsingham).

REMARKS: This species and *A. calcifer* differ superficially only by the lack of hair tufts on metatibial spurs and greater number of forewing spots in *calciferoides* (3 costal and 3 dorsal vs. 2 in *calcifer*). These features become obscure in worn specimens because the hair tufts and the forewing spots of *A. calcifer* can be lost. The male genitalia of the two species, however, are distinctly different (Figs. 102, 103).

Galapagoensis Group
(Figs. 41, 56, 104, 146, 218)

Included species: *A. galapagoensis* (Heppner and B. Landry, 1994), new combination.

DIAGNOSIS: Metatibia with large hair tuft. Socii flattened. Aedeagus with dorsal

hook distally.

Head: Scales behind eyes linear, conspicuous. Antenna about as long as forewing. **Thorax:** Metallic gray with pleural metallic orange patch. Metathoracic tibia with prominent, swollen, hair tufts. Inner medial spur less than 1.2 X longer than outer. **Forewing:** (Fig. 41) 10 veins; R1, R2 stalked with Rs; R4 and R5 connate proximally. Metallic gray with orange costal band near base. **Hindwing:** 5 veins, all separate. **Abdomen** (Fig. 56): A8 of male with tergum reduced to a transverse lobe; pleura heavily sclerotized, doubly emarginate. **Male genitalia** (Fig. 104): Tegumen divided dorsally. Socii enlarged, flattened laterally. Valva setose on inner wall, thickened at base. Phallus robust, phallobase strongly enlarged. Aedeagus with a dorsal hook at distal end. Cornuti spoon-shaped. **Female genitalia** (Fig. 146): Ventral bridge of apophyses anteriores triangular, with strong setae on ventral surface. Apophyses anteriores shorter than posteriores. Sterigma elaborately sclerotized. Ductus bursae shorter than corpus bursae. Signum simple, forming an invaginated fin-like process on ventral wall of corpus bursae.

Larval host is Nyctaginaceae (Order Caryophyllales).

Aetole galapagoensis (Heppner and B. Landry), New combination
(Figs. 41, 56, 104, 146, 218)

Heliodines galapagoensis Heppner and B. Landry, 1994: 126.

MALE. FW length 3.3-3.5 mm (3.37 ± 0.12 mm, $n = 3$). **Head:** Frons and vertex metallic fuscous. Antenna metallic fuscous, basal half banded with white dorsally at each segment. Scaling behind eyes white. Labial palpus white mottled with metallic gray. **Thorax:** Metallic gray tinged with blue, especially on pleura. Pleuron of prothorax with small patch of flame-scarlet behind head; pleura of meso- and metathorax extensively covered by metallic orange and yellow. Prothoracic legs metallic gray; a patch of dark orange on ventral surface of coxa proximally. Mesothoracic femur cream-white, tibia and basal portion of 1st tarsomere cream colored with patches of metallic black and dull orange near proximal end of tibia. Metathoracic coxa cream-white; tibia with enormously enlarged scale tufts, especially dense around spurs; color variegated, with dorsal area, ventral portion, and areas around spurs metallic black; tibia with a lateral, metallic chrome orange band and a short metallic gray or cream colored streak dorsal to orange band at base of tibia; 1st tarsomere with basal half metallic cream-yellow. Inner medial spur of metatibia approximately 1.1 X longer than outer. **Forewing:** Metallic gray with small area of pale black at base. A metallic chrome orange costal band to basal 1/2. Scattered chrome orange mottled with gray scales on dorsal 1/2, especially prominent near apex. An inconspicuous pale yellow subbasal marking near dorsal margin in some specimens. Fringe metallic fuscous. **Hindwing:** Metallic gray tinged with chrome

orange. Fringe metallic chrome orange, paler toward tornus. **Abdomen:** Metallic chrome orange dorsally, cream-white ventrally; distal end chrome orange mixed with cream-white. **Genitalia:** As in Fig. 104 (drawn from YFH slide 0951, CNC; n = 1). Tegumen with posterior end forming two symmetrical, broad, elongate lobes, gradually tapering to pointed, distal processes. Socii prominent, moderately setose, forming laterally flattened large lobes with distal hook curved downward. Saccus slightly attenuate distally, ending with a swollen club of irregular shape, approximately 1.5 X tegumen length. Phallus robust, with phallobase slightly attenuate toward distal end, approximately 0.95 X tegumen + saccus. Aedeagus with blunt distal end; dorsal hook sharp. Spoon-like cornuti setate anteriorly.

FEMALE. FW length 3.6-3.8 mm (3.67 ± 0.12 mm, n = 3). Color pattern as described for male, except female has a prominent subbasal pale yellow marking on forewing and more extensive cream-white at terminal end of abdomen. **Genitalia:** As in Fig. 146 (drawn from BL slide 307, CNC; n = 1). Ventral bridge of apophyses anteriores with posterior half diffuse. Lamella antevaginalis forming transverse, setose, sclerotized fringe. Lamella postvaginalis forming broad sclerotization with a pair of lateral depressions. A funnel-like antrum around ostium bursae. Signum a large fin with obtuse terminal end.

TYPE MATERIAL: Holotype: ♂: **ECUADOR: GALAPAGOS IS.: Santa Cruz:** CDRS (arid zone), 18.I.1989, ♂ *Cryptocarpus* sp., slide JBH 2025, type #21932 (B. Landry, CNC). **PARATYPES EXAMINED: ECUADOR: GALAPAGOS IS.:** 1 ♂, 3 ♀, Española, Bahía Manzanillo, 25.IV.1992, day (B. Landry, CNC, UCB); 1 ♂, Genovesa, Bahía Darwin, 10.III.1992, MV light (B. Landry, CNC); 1 ♂, Santa Cruz, E.C.C.D. 6.III.1992, UV light (B. Landry, CNC).

GEOGRAPHIC RANGE: Ecuador (Galapagos Islands).

BIOLOGY: The larva is a leaf miner in *Cryptocarpus pyriformis* HBK (Nyctaginaceae) (Heppner and Landry 1994).

COPOCENTRA Meyrick
(Figs. 43, 105, 148, 219)

Copocentra Meyrick, 1909: 34.

Type species: *Copocentra calliscelis* Meyrick, 1909; by monotypy. Gender feminine.

DIAGNOSIS: FW ground color metallic dark gray or black. Phallus much longer than length of tegumen + saccus. Coremata containing filiform scales. Appendix bursae present. Signa consisting of 2 transverse, invaginated processes on one side of corpus

bursae.

Genitalia: *Copocentra* sp. male, Fig. 105 (drawn from EME slide 3794, Costa Rica; n = 2); female, Fig. 148 (drawn from EME slide 3798, Sinaloa, Mex.; n = 1).

Literature references: Meyrick 1909: 34; 1922: 587; 1936: 106.

Included species: Five described South American species (Table 1) and two or more undescribed Central American species.

SCELORTHUS Busck
(Figs. 42, 46, 106, 147, 155, 160, 166, 169, 220)

Scelorthus Busck, 1900: 239.

Type species: *Scelorthus pisoniella* Busck, 1900: 240; by monotypy. Gender masculine.

DIAGNOSIS: FW ground color metallic dark gray or black. Phallus length approximately equal to length of tegumen + saccus. Appendix bursae present. Signa absent.

Male genitalia as in Fig. 106 (drawn from YFH slide 0839, Florida, FSCA; n = 5); female as in Fig. 147 (drawn from EME slide 3782, Florida; n = 3).

Literature Reference: Busck, 1900: 239 (Florida).

Included species: Monobasic (Table 1). North America and Greater Antilles.

INCERTAE SEDIS

'Heliodines' aureoflamma Walsingham

Heliodines aureoflamma Walsingham, 1897: 110; Meyrick, 1913: 17, 1914b: 20; Heppner, 1984: 57.

We have been unable to locate the type specimen, which was stated to have been deposited in the Hedemann collection (Walsingham 1897). We have not examined any specimens recognizable as this species. Following is the original description.

Male. "Antennae and palpi shining bronzy grey, the latter somewhat paler. Head and thorax shining bronzy grey, the face and the underside of the thorax shining pale

aeneous. *Fore wings* golden orange, with two basal streaks, five spots, and two apical streaks all shining chalybeous; the two basal streaks lie along the upper edge of the fold and along the dorsum respectively; the spots are two subcostal before and beyond the middle and three dorsal alternating with them, the second dorsal being between the two subcostal ones; the apical streaks lie one below the costa, the other commencing nearer to the apex and running along the base of the subapical cilia; cilia bronzy grey. *Exp. al.* 8 mm. *Hind wings* bronzy brownish; beneath shining pale aeneous. *Legs* shining steel-grey; tibiae orange.”

Female. Unknown.

TYPE MATERIAL. Holotype: ♂: **West Indies, St. Thomas**, 9.III [no year given] (Hedemann) (Mus. Hedemann).

Biology. “The moth holds the second pair of legs outstretched as in *Stathmopoda*” (Hedemann, cited in Walsingham 1897). Hedemann presumably erred, mistaking the metathoracic legs for the mesothoracic. The observation suggests that *aureoflamma* is a species of *Embola* or *Aetole*.

‘*Heliodines*’ *marginata* Walsingham
(Fig. 107)

Heliodines marginata Walsingham, 1892a: 535.

Lamprolophus marginata; Meyrick, 1913: 17, 1914b: 19; Heppner, 1984: 57 (checklist).

Male. FW length 3.3 mm (n = 1). **Head:** Frons and vertex metallic dark gray. Labial palpus metallic gray with darker apical tip. **Thorax:** Metallic dark gray, with prominent, elongate, yellow patch laterally. Legs metallic gray; mesotibia and metatibia with outer surfaces black except areas adjacent to spurs; inner medial spur of metatibia approximately 2.0 X longer than outer one. **Forewing:** Metallic orange with black metallic margin; 2 costal, metallic gray spots close to base, distal one slightly larger than proximal one. Fringe metallic dark gray. **Hindwing:** Uniformly metallic black. Fringe dark gray. **Abdomen:** Not observed. **Genitalia:** As in Fig. 107 (drawn from photo, holotype slide 9373, BMNH; n = 1). Socii short, rectangular, laterally flattened, with distal end truncated, 0.2 X tegumen length; saccus approximately 4.0 X tegumen length, distal end attenuated into a sharp point. Valva slender, elongate, with distal end slightly enlarged. Phallus subequal in length to tegumen + saccus, slightly curved downward distally, with lateral grooves, distal end truncated.

Female. Unknown.

Type Material: Holotype:♂: **West Indies, St. Vincent**, windward side (H. H. Smith, Walsingham Coll., 65316, BMNH slide no. 9373).

'Heliodines' urichi Busck
(Fig. 149)

Heliodines urichi Busck, 1910b: 245; Meyrick, 1913: 17, 1914b: 20; Heppner, 1984: 57 (checklist).

Male. Unknown.

Female. FW length 3.9 mm (n = 1). **Head:** [lacking from holotype] "Antennae dull blackish brown. Face and head steely bluish black. Tongue and labial palpi ochreous" (Busck 1910b). **Thorax:** Dorsal scaling steel gray; venter paler, silvery gray with bright orange scale tufts laterally under base of FW. Legs blackish dorsolaterally with indistinct silvery bands at mid-tibia and distal ends of tibia and tarsal segments; silvery on inner side. **Forewing:** Ground color pale orange, base of costa black, remainder of basal area narrowly silvery gray; 7 raised metallic silvery spots, narrowly edged by black: 4 short bars perpendicular to costa, equally spaced from 0.2 to beyond cell; 3 smaller spots along dorsal margin opposing intervals between costal bars, basal one largest. Terminal area, including fringe, from costa well before apex to tornus dark gray, encompassing a longitudinal, silver-gray bar from beyond cell to base of fringe that divides the terminal orange ground into two attenuate streaks. Underside and HW not visible [unspread specimen]. **Hindwing:** Underside shining gray, fringe dark gray. **Abdomen:** Color "silvery" (Busck 1910b). **Genitalia:** As in Fig. 149 (drawn from YFH slide 0971, holotype, USNM; n = 1). Ventral bridge of apophyses anteriores slender, short. A strong lateral accessory pouch at origin of corpus bursae. Signum a moderately broad keel with a cord-like distal extension near proximal end of corpus bursae.

Type Material: Holotype:♀: **British West Indies, Trinidad**, St. Clair (F. W. Urich collr., USNM no. 13884).

Biology: The type specimen was taken "on flowers of black sage" (*Cordia cylindrostachya* Roem. and Schult.) [Boraginaceae].

BIOLOGY

LARVAL HOST PLANT RELATIONSHIPS

On a world basis, heliodinids are food plant specialists. Of the 33 species for which larval hosts are known, 90% feed on plants in the Order Caryophyllales (Aizoaceae, Chenopodiaceae, Nyctaginaceae, Phytolaccaceae, or Portulacaceae), while three species specialize on Araliaceae (Order Apiales), Onagraceae (Order Myrtales), or Piperaceae (Order Piperales) (Table 6). Host records of other plant families reported for heliodinids do not pertain to Heliodinidae as defined in this work.

Until recently the immature stages of the heliodinids were poorly known (Powell 1980). Host plants of 11 species were known before 1990, and 4 additional species were recorded in the literature between 1991 and 1994 (Table 6). Hosts of 14 more species were discovered during our fieldwork from 1991 to 1994. Unreported host associations were found for three species in museum collections, and L. Wolfe added one species from Costa Rica (Harrison, pers. com.) (Table 6). In total, our knowledge of the larval host plants of Heliodinidae has increased to 33 species.

There are 25 or 26 species of heliodinids known to use Nyctaginaceae as larval hosts (Table 6), approximately 75% of those for which larval host plants are recorded, and use of Nyctaginaceae appears to be a worldwide pattern (Powell 1980, Powell et al. 1999, present data). Four other plant families, Aizoaceae, Chenopodiaceae, Phytolaccaceae, and Portulacaceae, are members of the Order Caryophyllales together with Nyctaginaceae, based on the classifications of Cronquist (1981) and Mabberley (1987). These five families combined are used by 30 species of heliodinids in 12 genera or species groups of *Aetole*, including the basal lineages (Fig. 6). Hence there is little doubt that Caryophyllales is the ground plan for heliodinid larval host associations.

Among Caryophyllales feeders that do not use Nyctaginaceae, Chenopodiaceae and Phytolaccaceae feeding are found in the most basal lineage, the European *Heliodines roesella*, suggesting that specialization to Caryophyllales feeding occurred in the early evolution of the Heliodinidae. Chenopodiaceae and Phytolaccaceae feeding may be interpreted as the most plesiomorphic condition of heliodinid host associations, with Nyctaginaceae feeding subsequently evolved and widely used during radiation of extant heliodinids. Alternatively, Nyctaginaceae feeding may be the ground plan for the Heliodinidae; Chenopodiaceae and Phytolaccaceae feeding may be derived from Nyctaginaceae feeding during the long history of isolation of the *H. roesella* lineage.

Portulacaceae and Aizoaceae feeding are confined to the Bella Group of *Aetole*. There is no doubt these adaptations were derived from the Nyctaginaceae feeding state, since the sister lineages of the Bella Group utilize Nyctaginaceae as larval hosts (Fig. 6).

The remaining three plant families used by heliodinid larvae, Onagraceae

(Myrtales), Araliaceae (Apiales), and Piperaceae (Piperales), are remote from Caryophyllales in plant phylogeny (Cronquist 1981; Dahlgren 1980; Thorne 1981).

Onagraceae feeding is found only in one species, *Aetole extraneella* of the Extraneella Group (Table 1). The sister taxon of the Extraneella Group is the Tripunctella Group (Fig. 1), which contains six species, with hosts known for five; all five feed on Nyctaginaceae (Table 6). The Eximia Group, which is basal to both the Extraneella and Tripunctella Groups, also feeds on Nyctaginaceae (Table 6). Hence phylogenetic relationships clearly indicate Onagraceae feeding is derived from an ancestral Nyctaginaceae feeding state.

Araliaceae feeding is limited to *Epicroesa chromatorhoea* Diakonoff and Arita, which is endemic in the northern part of Japan (Honshu and Hokkaido) (Diakonoff and Arita 1979). The genus *Epicroesa* occurs in the subtropical Old World, with its center of diversity in subtropical northeastern Australia (Queensland). *E. chromatorhoea* is the only species living in the temperate climate zone. Hosts of three or four other *Epicroesa* species are known; all use *Pisonia* (Nyctaginaceae) as larval hosts (Table 6; Floater 1995). This suggests that Araliaceae feeding is derived from ancestral Nyctaginaceae feeding. A problem with this scenario is that no *Pisonia*-feeding *Epicroesa* has been reported from Japan. However, *Pisonia* species are present along with Araliaceae in the Okinawa Islands, the Ogasawara Islands (Walker 1976), and Taiwan (Liu et al. 1976). Moreover, an undescribed species of *Pisonia* feeding *Epicroesa* has been found in Taiwan (Hsu, unpubl. data).

Piperaceae feeding is alleged in one South American species, "*Embola obolarcha*" (Monte 1934; Lima 1936, 1945, 1968). Three other *Embola* species feed on or are associated with *Mirabilis* (Nyctaginaceae) (Table 6), so if the South American record is valid, it is likely that Piperaceae feeding is derived from ancestral Nyctaginaceae feeding. However, the early records (Monte 1934; Lima 1936) may be based on misidentifications of the moth, which are common among early heliodinid studies. The larvae of the other *Embola* species are stem borers, namely *E. ionis* (Wester 1956, Harrison and Passoa 1995) and *E. powelli* (Hsu 2002), differing from the cecidomyiid gall-boring behavior of Monte and Lima's records. Adoption of gall feeding may be an opportunistic behavior by a stem borer, as appears to be true of *Aetole schulzella*, and the record cannot be discounted.

There are 72 described heliodinid species, including those treated in this study. Only 24 species in 9 genera of Nyctaginaceae have been documented as hosts of heliodinids, while there are more than 400 described species in 31 genera (Bittrich and Kühn 1993). Only 5 out of 12 families of Caryophyllales, as recognized by Cronquist (1981) are known as heliodinid larval hosts. These numbers, combined with the fact that a single Nyctaginaceae species may host up to four heliodinid species (Harrison and Passoa 1995), suggest that the total diversity of Heliodinidae may be considerably greater than that discovered to date.

Heliodinidae is the only Lepidoptera family that specializes on Nyctaginaceae (Powell 1980; Powell et al. 1999). The only other taxon specialized on this plant family is the genus *Nealyda* (Gelechiidae) (Clarke 1946; Hsu unpubl. data, UCB specimens), but Nyctaginaceae is just one of more than 80 plant families used by

Gelechiidae (Powell 1980).

LIFE HISTORY, VOLTINISM, AND DIAPAUSE

Collection dates for adults and larval and rearing records indicate the majority of heliodinids are multivoltine. Adult activities typically are closely tied to the seasonal phenology of their larval hosts. Pupal diapause over winter has been recorded in various temperate zone species: *Neoheliodines nyctaginella* (Wester 1956), *N. cliffordi* (Harrison and Passoa 1995), *N. vernius* (JAP 93C7, C12, E9), *Embola ionis* (Wester 1956); and for *N. hodgesi* in a subtropical area (JAP 93L13); whereas *Aetole extraneella* (JAP 92K7), a temperate zone species, demonstrates larval diapause.

Pupal diapause through the dry season probably occurs in many species, having been observed in *Neoheliodines vernius* inhabiting arid areas (JAP 93C7, C12, E9) and in *N. hodgesi* in subtropical deciduous forests (JAP 93L13). Facultative prolonged diapause was confirmed in one species, *N. vernius* (JAP 93E9). Some individuals collected as larvae in May 1993 in Arizona developed without diapause, adults emerging in June 1993 (n = 3), while others remained in pupal diapause. A portion of the diapausing individuals emerged in February and March 1994 (n = 4), and one adult emerged in February 1995. In addition, some pupae of *N. hodgesi*, from a subtropical deciduous forest habitat in southern Baja California, collected in November 1993 appeared to be viable after more than 1.5 years in diapause (JAP 93L13), although they later desiccated and died.

BEHAVIOR

Most heliodinids are diurnal moths. Adults feed at flowers of the larval hosts and unrelated plants growing near the hosts (Powell 1991, present data). Although *Neoheliodines vernius* was observed taking nectar on *Mirabilis tenuiloba* nocturnally in March at a site in southern California, where the nectar source was available only during the night, this moth was found feeding on *M. californica*, *M. bigelovii*, and other flowers diurnally at other sites.

Embola ciccella, the largest heliodinid species, is the only species collected primarily at lights. All others for which there are direct field observations, or several collections made by other observers for which circumstances can be verified, are diurnal. Nonetheless, occasional individuals of the diurnal species are attracted to lights. For example, adults of *Aetole prenticei* were observed active diurnally in large numbers, including feeding and mating, yet two specimens came to black light at Antioch, California, where no colony of the host plant is known.

MATING

Diurnal mating was observed in *Aetole extraneella*, *A. prenticei*, *Embola cyanozostera*, *E. powelli*, and *Neoheliodines vernius*. The last species, for which many pairs were observed, mates at various hours of the day; we saw copulation as early as

1000 hr PST and as late as 1600 hr PST in southern California. The duration of mating of *N. vernius* was observed to last longer than four hours.

HIND LEG POSTURE

All members of *Aetole* and *Scelorthus* and some of the *Embola* species that have been observed hold their hind legs elevated 45° or greater above the body axis in repose (Fig. 152). There is no known function of this behavior, which occurs in moths of a few other superfamilies, for example, Schreckensteiniidae (Schreckensteinoidea) and stathmopodine Oecophoridae (Gelechioidea). *A. extraneella* waves its hind legs when perching on the tops of plants during the daytime (Fig. 152). In *Aetole* and other heliodinids the hind leg raising behavior may have a function in species recognition; *Aetole* species, which have rudimentary coremata, all perform this behavior, suggesting that visual display may play a role in mate recognition. However, all *Scelorthus* and some species of *Embola*, which have well-developed coremata, also elevate their legs.

OVIPOSITION

Eggs of heliodinids are ovate-shaped sacs with a thin chorion; they are deposited singly on the hosts. Oviposition sites vary in leaf-mining heliodinids. Eggs of *Aetole extraneella* normally are deposited on the undersides of leaves but occasionally on stems and fruits (JAP 93J9, J11). *A. prenticei* lays eggs on leaves, flowers, and succulent stems of the host (JAP 91K14). Egg placement by skeletonizing species of *Neoheliodines* also varies. Eggs of *N. nyctaginella* are laid on both sides of leaves and flower buds (Wester 1956), while *N. cliffordi* oviposits on the undersides of leaves (Harrison and Passoa 1995). *N. vernius*, an external feeder of flower buds, deposits eggs on the flower buds (JAP 93C13). The stem-boring *Embola ionis* deposits eggs on axillary buds (Wester 1956).

LARVAL BIOLOGY

Larvae of heliodinids employ a variety of feeding strategies. Individual species specialize as leaf skeletonizers, leaf miners, stem borers, seed borers, cecidomyiid gall borers, or external feeders on flower and fruit buds. Although larvae of closely related species tend to feed in a similar manner, the feeding behavior is variable in some species of *Lithariapteryx* and *Aetole* (Powell 1991, JAP 93L23).

The most basal lineages such as *Heliodines roesella* and *Epicroesa* are external feeders, suggesting the ground plan state. An undescribed *Epicroesa* species in the Seychelles Islands was reported to be a seed borer (Floater 1995), but this behavior evidently was facultative. The larva also fed externally on flower clusters, and Floater suggested that larvae eat leaves when flowers and fruit are not available. External feeding also occurs in *Neoheliodines nyctaginella* (Wester 1956), *N. cliffordi*

(Harrison and Passoa 1995), *N. vernius* (JAP 93C5, C7, C12, E9), *Scelorthus pisoniella* (Busck 1900), and *Scelorthus* n. sp. in Florida (Hsu unpubl. data: JAP 94D91, D92, D93), but in these two genera larvae feed as leaf miners in the early instars.

Leaf-mining behavior occurs throughout the larval stages in *Aetole* (*A. bella*, JAP 93L23; *A. cera*, JAP 93E15, E16, E17, E18, 94C72; *A. eximia*, JAP 93L15, L17.1; *A. extraneella*, JAP 92J5, J9, 93J1, J7, J9, J11, J41; *A. favonia*, JAP 92D102, D103, D104.1; *A. fulgida*, JAP 93L23.1; *A. galapagoensis*, Landry, pers. com.; *A. inusitata*, JAP 93L20; *A. prenticei*, JAP 91K10, K14, 92C108, G19, H34, J5, J8, J9, J42, 93D42; *A. tripunctella*, Harrison and Passoa 1995; *A. unipunctella*, JAP 93F51, L11, L15.1, L17, L18). In *Lithariapteryx*, mining sometimes occurs throughout larval life but is facultative, depending in part on leaf thickness (Comstock 1940, Powell 1991).

The Bella Group of *Aetole* generally are leaf miners, but larvae feed facultatively in other substrates, such as cecidomyiid galls. Two species of the Bella Group, *A. schulzella* (Walsingham 1897) and *A. bella* (BMNH, USNM specimens), are known to invade cecidomyiid galls. Moreover, a larva of *A. bella* was observed boring into succulent stems of the host (JAP 93L23). A species identified as *Embola obolarcha* (Monte 1934; Lima 1936, 1945, 1968) was reported to infest cecidomyiid galls, but the taxonomic status of the Monte and Lima species is uncertain.

Larvae of the distantly related *Lamprolophus* and *Embola* lineages bore into host plant stems. This behavior in *Lamprolophus* is facultative, with larvae unmodified in morphology. Larvae of *L. lithella* preferred young stems, and frass was ejected through a hole on the stem (Busck 1900). *Lamprolophus* larvae we observed made hollow cavities in stems and bored into a new stem when an old stem deteriorated (Hsu 2002). Multiple larvae of *L. lithella* were observed in a single cavity in a young stem (JAP 94D98). In contrast, larvae of *Embola* are obligate stem borers (*E. ionis*, Harrison and Passoa 1995, Wester 1956; *E. powelli*, Hsu 2002) and possess shortened prothoracic legs (*E. powelli*, JAP 94C62, C54, G25). The larva of *E. powelli* makes a linear gallery in the stem and deposits frass in the gallery.

PUPAL BIOLOGY

Pupation by most heliodinids occurs on an exposed surface, without a visible cocoon. The larvae of leaf-mining *Lithariapteryx* (Powell 1991) and *Aetole* leave the mines and pupate on the vegetation or other surfaces (*A. bella*, JAP 93L23; *A. cera*, JAP 93E15, E16, E17, E18, 94C72; *A. eximia*, JAP 93L15, L17.1; *A. extraneella*, JAP 92J5, J9, 93J1, J7, J9, J11, J41; *A. favonia*, JAP 92D102, D103, D104.1; *A. fulgida*, JAP 93L23.1; *A. inusitata*, 93L20; *A. prenticei*, JAP 91K10, K14, 92C108, G19, H34, J5, J8, J9, J42, 93D42; *A. tripunctella*, Harrison and Passoa 1995; *A. unipunctella*, JAP 93F51, L11, L15.1, L17, L18). The leaf-skeletonizing and flower- and fruit-feeding *Neoheliodines* pupate on the ground: *N. nyctaginella*, Wester (1956); *N. vernius*, JAP 93C5, C7, C12, E9.

The stem-boring *Lamprolophus* (*L. lithella*, Hsu, unpubl. data: JAP 94D98) and *Embola* (*E. ionis*, Wester 1956; *E. powelli*, JAP 93D39, D41.1, 94C54, C62, G25)

pupate in the larval galleries. The pupa of *Lamprolophus* is typical in morphology (Fig. 14), flattened dorsoventrally with well-developed lateral ridges; multiple pupae sometimes are found in a large cavity in thick, young stems (*L. lithella*, Hsu, unpubl. data: JAP 94D98). The pupa of *Embola* is modified, with lateral ridges greatly reduced, so the entire body becomes cylindrical (Fig. 17) (*E. powelli*, Hsu, 2002). The pupae of the leaf skeletonizing *Scelorthus* (*S. pisoniella*, Hsu, unpubl. data: JAP 94D88, D97; *S. n. sp.*, Hsu, unpubl. data: JAP 94D91, D92) and *Epicroesa* (*n. sp.?*, Hsu, unpubl. data: JAP 94L1) are attached to vegetation.

SUMMARY

Heliodinidae are a group of lower ditrysian moths defined by five synapomorphies: (1) smooth head scaling; (2) forewing M veins two-branched; (3) ventral branches of apophyses posteriores fused into a medial band; (4) tegumen enormously expanded posteriorly; and (5) pupa with dorsal and lateral bristles. Heliodinids are found on all major continents, inhabiting a wide variety of environments.

Hind leg elevation behavior, formerly thought to be an important character to distinguish Heliodinidae, is not unique to the family and has not been observed in basal lineages of Heliodinidae.

All heliodinids having primarily orange or red forewings previously were grouped in the genus *Heliodines*. A cladistic analysis using representatives of six families in Yponomeutoidea as the outgroups and parsimony and character compatibility as the optimality criteria indicates that the moths formerly assigned to *Heliodines* form a polyphyletic assemblage. Two old generic names are resurrected from synonymy, and three new genera are proposed to ensure monophyly of taxa.

The genus *Aetole* is the best supported clade, recognized by at least four synapomorphies: (1) heavily sclerotized 8th abdominal pleural lobes in males; (2) a reduction in the tergum of the 8th abdominal segment; (3) a reduction in coremata with internal scales missing; and (4) only one postspiracular lateral bristle on the pupa, in contrast to two in other heliodinids.

We treat 45 North and Central American species that were formerly assigned to *Heliodines* or *Embola* (20) or are congeneric and described as new (25). In addition, to complete the phylogenetic picture, three previously described, extralimital species, one South American, one European, and one Australian, are included in the analyses, redescribed, and illustrated.

Heliodinidae specialize on plants of the order Caryophyllales; 90% of the species for which larval hosts are known feed on one of five families of Caryophyllales (Aizoaceae, Chenopodiaceae, Nyctaginaceae, Phytolaccaceae, or Portulacaceae). This is the only lepidopteran clade above the generic level that is primarily dependent on Caryophyllales and particularly Nyctaginaceae. Cladistic analysis indicates that a few derived species have shifted secondarily to Myrtales, Apiales, and Piperales. Larvae employ a variety of feeding strategies, including leaf skeletonizing, stem boring, leaf mining, and opportunistic invasion of cecidomyiid galls. Heliodinids overwinter as larvae or pupae. Prolonged diapause is exhibited by at least one species, *Neoheliodines vernius*, and may be a strategy used by many heliodinids in areas of seasonal drought.

TABLES

Table 1. List of described Heliodinidae. Abbreviations: **AF** = Afrotropical; **AN** = Caribbean Antilles; **AU** = Australian; **CA** = Central American, including Mexico; **NA** = North American north of Mexico; **PA** = Palaeartic; **SA** = South American, including Trinidad.

Taxa	Distribution
Heliodines assemblage	
Heliodines Stainton, 1854	
<i>Heliodinides</i> Turner, 1941, missp.	
<i>roesella</i> (Linnaeus, 1758)	PA
Epicroesa assemblage	
Epicroesa Meyrick, 1907	
<i>ambrosia</i> Meyrick, 1907	AU
<i>calliteucha</i> Meyrick, 1912	AU
<i>chromatorhoea</i> Diakonoff and Arita, 1979	PA
<i>metallifera</i> Meyrick, 1907	AU
<i>thiasarcha</i> Meyrick, 1907	AU
Philocoristis Meyrick, 1927	
<i>catachalca</i> Meyrick, 1927	AU
Lamprolophus assemblage	
Lamprolophus Busck, 1900	
<i>lithella</i> Busck, 1900	NA, AN
Aetole assemblage	
Heliodines' princeps subassemblage	
'Heliodines' princeps lineage	
<i>princeps</i> Meyrick, 1906	AU
Lithariapteryx sub-assemblage	
Lithariapteryx Chambers, 1876	
<i>Lithariapteryx</i> Comstock, 1940, missp.	
<i>abroniaeella</i> Chambers, 1876	NA
<i>abroniella</i> Meyrick, 1913, invalid emend.	
<i>abromiella</i> Heppner, 1987, missp.	
<i>elegans</i> Powell, 1991	NA
<i>jubarella</i> Comstock, 1940	NA

loriculata (Meyrick, 1932)	SA
mirabilinella Comstock, 1940	NA
Neoheliodines Hsu, n. gen.	
albidentus Hsu, n. sp.	NA
arizonense Hsu, n. sp.	NA
cliffordi (Harrison and Passoa, 1995), n. comb.	NA
eurypterus Hsu, n. sp.	NA
hodgesi Hsu, n. sp.	NA
megostiellus Hsu, n. sp.	CA
melanobasilarus Hsu, n. sp.	NA, CA
nyctaginella (Gibson, 1914), n. comb.	NA
vernus Hsu, n. sp.	NA, CA
Aetole subassemblage	
Embola Walsingham, 1909	
<i>Crebalastis</i> Meyrick, 1915, n. syn.	
albaciliella (Busck, 1910), n. comb.	NA
<i>albiciliella</i> Meyrick, 1913, invalid emend.	
autumnalis Hsu, n. sp.	NA
cicella (Barnes and Busck, 1920), n. comb.	NA, CA
cyanozostera Hsu, n. sp.	NA
dentifer Walsingham, 1909	CA
<i>dentifera</i> Meyrick, 1913, invalid emend.	
erythorma (Meyrick, 1915), n. comb.	SA
friedlanderi Hsu, n. sp.	CA
ionis (Clark, 1952), n. comb.	NA, CA
melanotela Hsu, n. sp.	AN
obolarcha (Meyrick, 1909), n. comb.	SA
powelli Hsu, 2002	NA, CA
sexpunctella (Walsingham, 1892), n. comb.	NA
xanthocephala Walsingham, 1909	CA
Heliogemma Hsu, n. gen.	
gigantea Hsu, n. sp.	CA
grandis Hsu, n. sp.	CA
preclara Hsu, n. sp.	CA
Pseudastasia Walsingham, 1909	
opulenta Walsingham, 1909	CA
Euheliodines Hsu, n. gen.	
chemsaki Hsu, n. sp.	NA, CA
jaliscella Hsu, n. sp.	CA

Aetole Chambers, 1875	
<i>Aelole</i> Chambers, 1878b, missp.	
<i>Aetola</i> Frey, 1884, missp.	
Eximia Group	
eximia Hsu, n. sp.	CA
insolita Hsu, n. sp.	CA
Bella Group	
bella Chambers, 1875	NA, AN, CA
demarcha (Meyrick, 1917), n. comb.	SA
fulgida Hsu, n. sp.	CA
prenticei Hsu, n. sp.	NA
schulzella (Fabricius, 1794), n. comb.	NA, AN
<i>quinqueguttatus</i> (Walsingham), 1897, n. syn.	
Tripunctella Group	
cera Hsu, n. sp.	NA
favonia Hsu, n. sp.	NA
inusitata Hsu, n. sp.	CA
aprica Hsu, n. sp.	NA
tripunctella (Walsingham, 1892), n. comb.	NA, CA
<i>perichalca</i> Meyrick, 1922, n. syn.	
unipunctella (Walsingham, 1892), n. comb.	NA, CA
<i>metallicella</i> (Busck, 1909), n. syn.	
Extraneella Group	
extraneella (Walsingham, 1881), n. comb.	NA
Calcifer Group	
calcifer (Walsingham, 1909), n. comb.	CA
<i>calcifera</i> Meyrick, 1914, invalid emend.	
calciferoides Hsu, n. sp.	CA
Galapagoensis Group	
galapagoensis (Heppner and Landry, 1995), n. comb.	SA
Copocentra Meyrick, 1909	
calliscelis Meyrick, 1909	SA
notopyrsa Meyrick, 1935	SA
porphyropis, Meyrick, 1922	SA
saltatoria Meyrick, 1922	SA
submetallica Meyrick, 1922	SA
Scelorthus Busck, 1900	
pisoniella Busck, 1900	NA, AN
Copocentra/Scelorthus lineage incertae sedis:	
‘Heliodines’ choneuta Meyrick, 1915	SA

'Heliodines' isoleura Meyrick, 1917 SA

Incertae sedis:

'Heliodines' aureoflamma Walsingham, 1897 AN

'Heliodines' marginata Walsingham, 1892 AN

'Heliodines' urichi Busck, 1910 SA

Appendix to Table 1

I. Genera and species placed in Heliodinidae in recent lists (Heppner and Duckworth 1983; Heppner 1984; Nye and Fletcher 1991) that are excluded according to present definition.

Aenicteria Turner, 1926

Based on *A. termiticola* Turner, described from Cairns, Australia. Treated as synonym of *Physoptila* Meyrick (Gelechiidae) by Edwards (1996).

Amphiclada Meyrick, 1912

Based on *A. fervescens* Meyrick from Grenada, B.W.I. Belongs in Blastobasidae, based on examination of the type specimen in BMNH, although Clarke (1955) indicated the type was not located in BMNH.

Cycloplasis Clemens, 1864

Based on *C. panicifoliella* Clemens, eastern United States, belongs in Yponomeutoidea but not Heliodinidae, family unplaced (Hsu, unpubl.).

Lissocarena Turner, 1923

Based on *L. semicuprea* Turner, described from Cairns, Australia. Treated as synonym of *Opogona* (Tineidae) by Robinson and Nielsen (1996).

Schreckensteinia Hübner, [1825]

Treated as the family Schreckensteiniidae by some earlier authors (Gaedike 1967); removed to a separate superfamily in Apoditrysia by (Minet 1983).

'*Elachista*' *rubella* Blanchard, 1852

Family placement uncertain (Clarke 1967)

'*Heliodines*' *nodosella* (Mann)

Illustrated as representative of Heliodinidae by Scoble (1992) and Dugdale et al. (1999), although it was long ago transferred to *Pancalia* Stephens (Gelechioidea: Cosmopterigidae) (Gaedike 1967, Kloet and Hincks 1972), later to Cosmopterigidae: Antequerinae (Hodges 1999).

II. Genera placed in Heliodinidae by the original authors or by Nye and Fletcher (1991), for which the systematic position is uncertain. Most are monobasic taxa known from single specimens so could not have been meaningfully included in our phylogenetic analysis.

Anypoptus Durrant, 1919

Described in Aegeriidae (= Sesiidae) based *Sphecia tricolor* Rothschild, one female specimen from Sarawak [Borneo]. Transferred to Heliodinidae by Nye and Fletcher (1991). Location of type not stated.

Bonia Walker, 1862

Proposed in Aegeriidae based on *B. unicolor* Walker, from Sarawak, Borneo. Transferred to Heliodinidae (s. lat.) by Hampson (1919), who found the unique type to be a female, not male as stated by Walker. Type presumably in BMNH, not found with the Heliodinidae. The moth is much larger than any known heliodinid ("wings, 12 lines" = 25 mm).

Coleopholas Meyrick, 1939

Based on *C. zonodecta* Meyrick from Java; larva a leaf miner in Bamboo, so unlikely to be Heliodinidae. Thought by Meyrick to be "probably allied to *Stathmopoda*." Location of type unknown (Clarke 1955).

Ecrectica Walker, 1864 [1865]

Proposed in Aegeriidae for *E. fasciata* Walker, one specimen from Ega [Brazil]. Transferred to Heliodinidae by Nye and Fletcher (1991). Type presumably in BMNH.

Encratora Meyrick, 1923

Based on *E. plumbigera* Meyrick, described from one female from Assam. Placed in Glyphipterigidae by Meyrick, as a "derivative of *Glyphipteryx*." Transferred to Heliodinidae by Heppner (1982). Type in BMNH, illustrated by Clarke (1969). There are 3 M veins in both forewing and hindwing, which is unknown in any heliodinid by present definition. The genitalia preparation is too poor, with the corpus bursae missing, to derive any conclusion as to family placement.

Gymnogelastis Meyrick, 1930

Based on *Melodryas miranda* Meyrick, 1913, one specimen from Trobriand Island, New Guinea. Placed in Heliodinidae (s. lat.) but "affinity puzzling." There is a second species thought by Meyrick to be congeneric, described from Sudest Island [Chagos Archipelago, Indian Ocean] by Meyrick (1930). Location of type unknown (Clarke 1955).

Hemicalyptris Meyrick, 1933

Based on *H. isemera* Meyrick, one specimen from Belgian Congo. Thought by Meyrick to be “allied to *Heliodines*.” Location of type unknown (Clarke 1955).

Hierophanes Meyrick, 1930

Based on *H. chrysocrana* Meyrick, described from Uganda. Thought by Meyrick to be nearly allied to the South American *Crembalastis* (= *Embola*). Type in BMNH.

Leuroscelis Turner, 1927

Based on *L. coracopis* Turner from Tasmania. The genus name was omitted from his revision of Australian Heliodinidae (Turner 1941), but *coracopis* was assigned to *Eretmocera* Zeller, which is considered to belong to Scythrididae (Gelechioidea) (Nye and Fletcher 1991).

Lisocnemitis Meyrick, 1934

Based on *L. argolyca* Meyrick from the Marquesas Islands [South Pacific]. Type in Bishop Museum (Clarke 1955).

Molybdurga Meyrick, 1897

Based on *M. metallophora* Meyrick, one female from Melbourne, Australia. Location of type unknown (Clarke 1955).

Thrasydoxa Meyrick, 1912

Based on *T. tyrocopa* Meyrick, one male, from Colombia. Location of type unknown (Clarke 1955).

Trychnopepla Turner, 1941

Based on *T. discors* Turner, from northern Queensland, Australia. Location of type not stated.

Wygodzinskyiana Hering, 1958

Placed in Heliodinidae by Hering, based on *W. amphiphilii* Hering, from Tucuman, Argentina. Type in Humboldt University, Berlin. Genitalia as illustrated do not match Heliodinidae, but the structures shown resemble *Embola* if the saccus and aedeagus were lost in preparation. Specimens reared from leaf-mining larvae in *Amphilophium* (Bignoniaceae) (Hering 1958), a plant family otherwise not known to be used by Heliodinidae (s. str.).

Table 2. Characters and states used in phylogenetic analyses of Heliodinidae. State 0 is inferred as the plesiomorphic condition.

<u>Character</u>	<u>States</u>
1. forewing veins R4 and R5	(0) separate; (1) stalked proximally
2. forewing vein CuA2	(0) present; (1) absent
3. hindwing vein CuA2	(0) present; (1) absent
4. forewing veins M1 and M2	(0) separate; (1) stalked proximally
5. frenulum of female	(0) double, symmetrical; (1) double, with one bristle shorter than the other; (2) single
6. condition of forewing	(0) flat; (1) distal half drooping
7. shape of scaling behind eyes	(0) linear, narrow, long, visible; (1) oblong, broad, short, not visible externally
8. shape of antenna	(0) cylindrical filiform; (1) flattened dorsoventrally
9. pleural lobes of A8 in male	(0) membranous or weakly sclerotized; (1) heavily sclerotized, modified to flat, simple plates; (2) heavily sclerotized, elaborately modified to somewhat rectangular plates with anterior rod-like and posterior digitate processes
10. male A8 tergum shape or	(0) not reduced; (1) reduced to a small lobe vestigial
11. male A8 tergum process	(0) no process; (1) a pair of triangular processes extending anteriorly beneath A7; (2) a pair of elongate rod-like processes extending anteriorly beneath A7
12. coremata	(0) present; (1) reduced into a membranous threadlike structure
13. medial spurs of metatibia	(0) inner spur > 1.5 X longer than outer one; (1) inner spur ≤ 1.5 X longer than outer
14. hind leg posture in repose	(0) not raised; (1) raised
15. signum/signa	(0) not, or shallowly, invaginated, with microteeth or minute spines on outer surface; (1) deeply invaginated, forming a single process, without microteeth or spines; (2) invaginated, forming 2 transverse processes; (3) absent
16. symmetry of signum/signa	(0) symmetrical, present both on dorsal and ventral wall of corpus bursae; (1) asymmetrical, present on dorsal and ventral

- wall of corpus bursae; (2) present on one side of corpus bursae only
17. texture of signum/signa (0) of one texture; (1) of two textures
18. ductus seminalis origin (0) on ductus bursae; (1) on corpus bursae
19. appendix bursae (0) absent; (1) present
20. apophyses anteriores ventral bridge (0) broad, triangular or somewhat rectangular;
- (1) sharply attenuate into a longitudinal bar
21. ductus bursae base (0) membranous, unmodified; (1) sclerotized into a cylinder
22. ductus bursae excluding base (0) membranous; (1) heavily sclerotized
23. tegumen distal end (0) undivided; (1) bifid
24. tegumen anterior end (0) unmodified; (1) produced laterally into a
- pair of processes
25. position of bulbus ejaculatorius on phallobase (0) subterminal position; (1) terminal
26. aedeagus terminal hook (0) absent; (1) present
27. aedeagus distal processes (0) absent; (1) present.
28. saccus distal end (0) not swollen into a spherical club; (1) swollen into a club
29. late instar larva A9 (0) two SV setae; (1) One SV seta
30. pupa A2-A7 lateral bristles (0) three; (1) two
31. larval feeding behavior (0) external feeding; (1) leaf mining; (2) stem boring; (3) cecidomyiid gall boring
32. head scaling (0) rough; (1) smooth
33. apophyses anteriores ventral branches (0) separated; (1) fused into a medial band
34. pupa dorsal and lateral bristles (0) absent; (1) present
35. tegumen (0) unmodified; (1) enormously expanded posteriorly
36. forewing M veins (0) three-branched; (1) two-branched; (2) reduced to single vein

Table 3. Data matrix of Heliodinidae. “?” denotes missing data, “-” no comparison. Multistate character within OTU: **a** = (01), **b** = (02), **c** = (03), **d** = (12), **e** = (23), **f** = (13).

Taxa	Character							
	12345	67890	11111	11112	22222	22223	33333	3
Copocentra	00102	00000	20113	--010	00000	0010?	31111	1
Scelorthus	01102	00000	20112	20010	00000	00100	01111	1
Pseudastasia	1100?	00100	000??	?????	?0000	011??	?1??1	1
Lithariapteryx	00002	00000	10000	21100	00000	00000	11111	1
Lamprolophus	00001	00000	00000	20000	00000	00000	21111	1
Epicroesa	00111	10000	00000	2-001	00000	00000	01111	1
Philocoristis	00011	10000	000?0	2-001	00000	000??	?11?1	1
Euheliodines	00110	00000	000?0	00000	10000	001??	?11?1	1
Embola	00002	00000	000a0	10000	00000	0a100	e1111	1
Neoheliodines	00002	00000	10000	211a0	10000	00010	01111	1
Heliogemma	00002	00100	000?0	20010	00000	011??	?11?1	1
Heliodines	10001	00000	000?0	20101	01000	00010	01111	1
‘H.’ princeps	00002	00000	000?0	20000	00000	000??	?11?1	1
Aetole bella group	11102	01011	01111	20100	00001	10001	f1111	1
A. tripunctella group	01102	01021	01111	20100	01111	00001	11111	1
A. calcifer group	01102	00011	01111	20100	00111	100??	?11?1	1
A. galapagoensis	11102	00011	01111	20100	10110	10001	11111	1
A. eximia group	01102	01011	01111	20000	01001	00001	11111	1
A. extraneella group	11102	01021	01111	20100	00110	00001	11111	1
Bedelliidae	-1100	000-0	0000-	--00-	0000-	0001-	10000	2
Lyonetiidae	-a100	000-0	00003	--?0-	0000-	0001-	20000	2
Glyphipterigidae	00000	000-0	00000	b01a-	00000	0001-	20000	0
Acrolepiidae	00000	00000	00000	0000-	0000-	0001-	d0000	0
Plutellidae	00000	00000	00003	--00-	00000	0001-	00000	0
Ypsolophidae	10000	00000	00000	2000-	00000	000a-	00000	0

Table 4. The modified data matrix of Heliodinidae for compatibility analysis.

Taxa	Characters					
	12345	1 67890	11111 12345	11112 67890	22222 12345	22223 67890
Copocentra	AABAC	AAAAA	CABBD	AAABB	AAAAA	AABAA
Scelorthus	ABBAC	AAAAA	CABBC	AAABB	AAAAA	AABAA
Pseudastasia	BBAAC	AABAA	AAABA	AAABB	AAAAA	ABBAA
Lithariapteryx	AAAAC	AAAAA	BAAAA	ABBAB	AAAAA	AAAAA
Lamprolophus	AAAAB	AAAAA	AAAAA	AAAAB	AAAAA	AAAAA
Epicroesa	AABBB	BAAAA	AAAAA	AAAAA	AAAAA	AAAAA
Philocoristis	AAABB	BAAAA	AAAAA	AAAAA	AAAAA	AAAAA
Euheliodines	ABBAA	AAAAA	AAABA	CAAAB	BAAAA	AABAA
Embola	AAAAC	AAAAA	AAABA	BAAAB	AAAAA	AABAA
Neoheliodines	AAAAC	AAAAA	BAAAA	ABBAB	BAAAA	AAABA
Heliogemma	AAAAC	AABAA	AAABA	AAABB	AAAAA	ABBAA
Heliodines	BAAAB	AAAAA	AAAAA	AABAA	ABAAA	AAABA
'H.' princeps	AAAAC	AAAAA	AAABA	AAAAB	AAAAA	AAAAA
Aetole bella group	BBBAC	ABABB	ABBBB	AABAB	AAAAB	BAAAB
A. tripunctella group	ABBAC	ABACB	ABBBB	AABAB	ABBBB	AAAAB
A. calcifer group	ABBAC	AAABB	ABBBB	AABAB	AABBB	BAAAB
A. galapagoensis	BBBAC	AAABB	ABBBB	AABAB	BABBA	BAAAB
A. eximia group	ABBAC	ABABB	ABBBB	AAAAB	ABAAB	AAAAB
A. extraneella group	BBBAC	ABACB	ABBBB	AABAB	AABBA	AAAAB

Table 5. Character trees constructed from Table 3 for the compatibility analysis.

Character	Character State Tree
1. forewing veins R4 and R5	A A
2. forewing vein Cu2	A A
3. hindwing vein CuA2	A A
4. forewing veins M1 and M2	A A
5. frenulum of female	A A B
6. condition of forewing	A A
7. shape of scaling behind eyes	A A
8. shape of antenna	A A
9. pleural lobes of A8 in male	A A B
10. male A8 tergum shape	A A
11. male A8 tergum process	A A A
12. coremata	A A
13. medial spurs of metatibia	A A
14. hindleg posture in repose	A A
15. signum/signa	A A B C
16. symmetry of signum/signa	A A A
17. texture of signum/signa	A A
18. ductus seminalis origin point	A A
19. appendix bursae	A A
20. apophyses anteriores, ventral band	A A
21. ductus bursae base	A A
22. ductus bursae excluding base	A A
23. tegumen distal end	A A
24. tegumen anterior end	A A
25. position of bulbus ejaculatorius	A A
26. aedeagus terminal hook	A A
27. aedeagus distal processes	A A
28. saccus distal end	A A
29. late instar larva A9 SV setae	A A
30. pupa A2-A7 lateral bristles	A A

Table 6. Larval host plant associations of Heliodinidae. AIZ = Aizoaceae; ARA = Araliaceae; CHE = Chenopodiaceae; NYC = Nyctaginaceae; ONA = Onagraceae; PHY = Phytolaccaceae; PIP = Piperaceae; POR = Portulacaceae. BMNH = unpublished data based on The Natural History Museum (London) specimens.

<u>TAXA</u>	<u>HOST PLANT (FAMILY)</u>	<u>REFERENCE</u>	
Heliodines			
roesella	Atriplex patula (CHE)	Emmet 1985	
	Chenopodium viride (CHE)	Morris 1870	
	C. bonus-henricus (CHE)	Roüast 1883	
	Phytolacca decandra (PHY)	Lhomme 1948	
	Spinacia oleracea (CHE)	Fal'kovich 1990	
Epicroesa			
chromatorhoea	Kalopanax septemlobus (ARA)	Diakonoff and Arita 1979	
metallifera	Pisonia aculeata (NYC)	BMNH	
n. sp.? (Taiwan)	P. aculeata (NYC)	Hsu unpubl. data	
n. sp.(Seychelles)	P. seychellarum (NYC)	Floater 1995	
n. sp.?(Seychelles)	P. grandis (NYC)	Floater 1995	
Lamprolophus			
lithella	Pisonia aculeata (NYC)	Busck 1900	
Lithariapteryx			
abroniaecella	Abronia latifolia (NYC)	Powell 1991	
	A. fragrans (NYC)	Chambers 1876	
	A. maritima (NYC)	Powell 1991	
	A. mellifera (NYC)	Powell 1991	
	A. umbellata (NYC)	Powell 1991	
	A. villosa (NYC)	Powell 1991	
	Mirabilis macfarlanei (NYC)	Powell 1991	
	M. multiflora (NYC)	Powell 1991	
	elegans	Abronia latifolia (NYC)	Powell 1991
		A. umbellata (NYC)	Powell 1991
	jubarella	Mirabilis sp. (NYC)	Comstock 1940
		M. bigelovii (NYC)	Powell 1991
		M. californica (NYC)	Powell 1991
		M. multiflora (NYC)	Powell 1991
mirabilinella	Abronia fragrans (NYC)	Powell 1991	
	Mirabilis sp. (NYC)	Comstock 1940	
	M. bigelovii (NYC)	Powell 1991	
	M. greenei (NYC)	Powell 1991	
?mirabilinella (NV)	Tripterocalyx crux-maltae (NYC)	Hsu unpubl. data	

Neoheliodines

cliffordi	Mirabilis longiflora (NYC)	Harrison & Passoa 1995
	M. nyctaginea (NYC)	Harrison & Passoa 1995
hodgesi	Boerhavia coccinea (NYC)	present data
nyctaginella	Mirabilis nyctaginea (NYC)	Wester 1956
vernus	M. californica (NYC)	present data
	M. bigelovii (NYC)	present data

Embola

ionis	Mirabilis nyctaginea (NYC)	Wester 1956
cyanozostera	M. multiflora (NYC)	present data
powelli	M. californica (NYC)	present data
obolarcha	Piper geniculatum (PIP)	Monte 1934
	P. luschnathiana (PIP)	Costa Lima 1945

Aetole**Bella Group**

bella	Portulaca oleracea (POR)	present data
fulgida	P. oleracea (POR)	present data
schulzella	P. oleracea (POR)	BMNH
prenticei	Sesuvium verrucosum (AIZ)	present data

Eximia Group

eximia	Boerhavia coccinea (NYC)	present data
	B. gracilima (NYC)	present data

Tripunctella Group

cera	Anulocaulis annulatus (NYC)	present data
favonia	Mirabilis bigelovii (NYC)	present data
	M. multiflora (NYC)	present data
inusitata	Commicarpus brandegeei (NYC)	present data
tripunctella	Mirabilis nyctaginea (NYC)	Harrison & Passoa 1995
unipunctella	Boerhavia coccinea (NYC)	present data
	B. gracilima (NYC)	present data
	B. spicata (NYC)	present data

Extraneella Group

extraneella	Clarkia sp. canum (ONA)	present data
	Epilobium(ONA)	present data
	E. brachycarpum (ONA)	present data
	E. densiflorum (ONA)	present data
	E. pygmaeum (ONA)	present data
	Gaura neomexicana (ONA)	Braun 1925

Galapagoensis Group

galapagoensis	Cryptocarpus pyriformis(NYC)	Heppner & Landry 1995
---------------	------------------------------	-----------------------

Scelorthus

pisoniella

Pisonia aculeata (NYC)

Busck 1900

Guapira discolor (NYC)

Busck 1900

n. sp. (Florida)

Pisonia rotundata (NYC)

Hsu unpubl. data

Copocentra

n. sp. (Costa Rica)

Neea psychotrioides (NYC)

Harrison unpubl. data

LITERATURE CITED

- Ashlock, P. 1974. The uses of cladistics. *Annual Rev. Ecol. Syst.* 5: 81-99.
- Barnes, W. and A. Busck. 1920. Notes and new species. *Contr. Nat. Hist. Lepid. N. Am.* 4: 245.
- Bittrich, V. and U. Kühn. 1993. Nyctaginaceae. pp. 473-486. *In*: K. Kubitzki, J. G. Rohwer, V. Bittrich (eds.), *The Families and Genera of Vascular Plants. II. Flowering Plants. Dicotyledons. Magnoliid, Hamamelid and Caryophyllid Families.* Springer-Verlag, Berlin and Heidelberg.
- Bland, K. P. 1992. A possible recent record of *Heliodines roesella* (Linnaeus, 1758) (Lepidoptera: Heliodinidae) from northern Lincolnshire. *Entomol. Gaz.* 53: 53.
- Braun, A. F. 1923. The Chambers specimens of Tineina in the collection of the American Entomological Society. *Trans. Am. Entomol. Soc.* 49: 347-358.
- _____. 1924. The frenulum and its retinaculum in the Lepidoptera. *Ann. Entomol. Soc. Am.* 17: 234-256, 1 pl.
- _____. 1925. Microlepidoptera of northern Utah. *Trans. Am. Entomol. Sci.* 51: 183-226.
- Brown, J. W. and J. A. Powell. 1991. Systematics of the *Chrysoxena* Group of Genera (Lepidoptera: Tortricidae: Euliini). *Univ. Calif. Publ. Entomol.* 111: 1-87.
- Busck, A. 1900. New American Tineina. *J. N.Y. Entomol. Soc.* 8: 234-248.
- _____. 1909. Notes on microlepidoptera, with descriptions of North American species. *Proc. Entomol. Soc. Wash.* 11: 87-103.
- _____. 1910a. New microlepidoptera from New Mexico and California and a synoptic table of the North American species of *Heliodines* Stainton. *Proc. Entomol. Soc. Wash.* 11: 175-188.
- _____. 1910b. List of Trinidad Microlepidoptera, with descriptions of new forms. *Bull. Dept. Agric. Trinidad* 9: 241-245.
- Chambers, V. T. 1875. Tineina from Texas. *Can. Entomol.* 7:73-75.
- _____. 1876. Tineina. *Can. Entomol.* 8: 217-220.

- _____. 1877. Tineina from Texas. *Can. Entomol.* 9: 71-74.
- _____. 1878a. Tineina and their food-plants. *Bull. U.S. Geol. Geog. Surv.* 4(1): 107-123.
- _____. 1878b. Index to the described Tineina of the United States and Canada. *Bull. U.S. Geol. Geog. Surv.* 4(1):125-167.
- _____. 1880. Illustrations of the neuration of the wings of American Tineina. *J. Cincinnati Soc. Nat. Hist.* 2: 16-26.
- Clarke, J. F. G. 1946. Synopsis of the genus *Nealyda* Dietz, with descriptions of new species (Gelechiidae: Lepidoptera). *J. Wash. Acad. Sci.* 36: 425-427.
- _____. 1952. A new heliodinid from Illinois. *Proc. Entomol. Soc. Wash.* 54: 138-139.
- _____. 1955. Catalogue of the Type Specimens of Microlepidoptera in the British Museum (Natural History) described by Edward Meyrick. Vol. I. *Brit. Mus. (Nat. Hist.)*, London. 332 pp.
- _____. 1967. Neotropical microlepidoptera, XIV, Chilean Microlepidoptera described by Emilio Blanchard. *Proc. U.S. Natl. Mus.* 122: 1-8.
- _____. 1969. Catalogue of the Type Specimens of Microlepidoptera in the British Museum (Natural History) described by Edward Meyrick. Vol. 6. *Brit. Mus. (Nat. Hist.)*, London. 537 pp.
- Clemens, B. 1864. North American Micro-Lepidoptera. *Proc. Entomol. Soc. Phila.* 2: 415-430.
- Common, I. F. B. 1990. *Moths of Australia*. E. J. Brill, Leiden, New York. vi + 535 pp.
- Comstock, J. A. 1940. Four new California moths with notes on early stages. *Bull. So. Calif. Acad. Sci.* 38: 172-182.
- Covell, C. V. 1984. *A Field Guide to Moths, Eastern North America*. The Peterson Field Guild Series. Houghton- Mifflin Co., Boston. 496 pp.
- _____. 1999. *The Butterflies and Moths (Lepidoptera) of Kentucky*. An Annotated Checklist. *Kentucky State Nat. Pres. Comm., Sci. Tech. Ser.* 6, Frankfort. xiv + 221 pp.
- Cronquist, A. 1981. *An Integrated System of Classification of Flowering Plants*.

Columbia U. Press, New York. 1262 pp.

Dahlgren, R. M. T. 1980. A revised system of classification of the angiosperms. *Bot. J. Linn. Soc.* 80: 91-124.

Diakonoff, A. 1968 ["1967"]. *Microlepidoptera of the Philippine Islands*. U.S. Natl. Mus. Bull. 257: 1-484.

Diakonoff, A. and Y. Arita. 1979. Three new species of the so-called Glyphipterigidae auctorum from Japan (Lepidoptera). *Zool. Meded.* 54: 95-100.

Dozier, H. L. 1920. An ecological study of hammock and piney woods insects in Florida. *Ann. Am. Entomol. Soc.* 3: 325-380.

Dugdale, J. S., N. P. Kristensen, G. S. Robinson, and M. J. Scoble. 1999. Chap. 8, Yponomeutoidea, pp. 119-130. *In*: N. P. Kristensen (ed.), *Lepidoptera, Moths and Butterflies. Handbook of Zoology. Vol. 4, Arthropoda: Insecta, Part 35*. W. de Gruyter, Berlin, New York. x + 487 pp.

Duncan, T. O. 1980. Cladistics for the practicing taxonomists - an eclectic view. *Syst. Bot.* 5: 136-148.

Dyar, H. G. 1903 ["1902"]. A list of North American Lepidoptera and Key to the Literature of This Order of Insects. *Bull. U.S. Natl. Mus.* 52, Washington, D.C.. 723 pp.

Edwards, E. D. 1996. Gelechiidae. *Monogr. Austral. Lepid.* 4: 107-114.

Emmet, A. M. 1985. Heliodinidae, pp. 410-411. *In*: J. Heath and A. M. Emmet (eds.), *The Moths and Butterflies of Great Britain and Ireland. Vol. 2. Cossidae - Heliodinidae*. Harley Books, Colchester. 460 pp.

_____. 1991. *The Scientific Names of the British Lepidoptera. Their History and Meaning*. Harley Books, Colchester. 288 pp.

Fabricius, J. C. 1794. *Entomologia systematica emendata et aucta*. 3(2) Hafniae. 349 pp.

Fal'kovich, M. I. 1990. Heliodinidae, pp. 699-700. *In*: G. S. Medvedev (ed.), *Keys to the Insects of the European Part of the USSR. Vol. IV. Lepidoptera, Part II. English edition*. E. J. Brill, Leiden, New York. 1092 pp.

Farris, 1969. A successive approximations approach to character weighting. *Syst. Zool.* 18: 374-385.

- Fiala, K. L. 1984. CLINCH. Version 6.2.
- Floater, G. J. 1995. Seed predation and flower visiting by *Epicroesa* sp. (Lepidoptera: Heliodinidae) on a rare Seychelles tree. *Phelsuma* 3: 31-36.
- Forbes, W. T. M. 1923. The Lepidoptera of New York and Neighboring States. Primitive Forms, Microlepidoptera, Pyraloids, Bombyces. Cornell Univ. Agric. Exp. Stat. Mem. 68. 729 pp.
- _____. 1930. Insects of Porto Rico and the Virgin Islands. Heterocera or Moths (excluding the Noctuidae, Geometridae and Pyralidae). *Sci. Surv. Porto Rico Virgin Islands*. 12: 1-171, 2 pls.
- Ford, L. T. 1949. A Guide to the Smaller British Lepidoptera. S. London Entomol. Nat. Hist. Soc. London. 230 pp.
- Friese, G. 1962. Beitrag zur Kenntnis der ostpalaearktischen Yponomeutidae (Lepidoptera). *Beitr. z. Entomol.* 12: 299-331.
- Gaedike, R. 1967. Zur systematischen Stellung einiger Gattungen der Heliodinidae/Schreckensteiniidae. Sowie Revision der Palaearctischen Arten der Gattung *Panacalia* Curtis, 1830. *Beitr. z. Entomol.* 17: 363-374.
- Geiser, S. W. 1948. *Naturalists of the Frontier*. Rev. ed. Dallas, So. Methodist U. Press, Dallas. 296 pp.
- Gibson, A. 1914. A new elachistid moth from Manitoba. *Can. Entomol.* 46: 423-424.
- Hagen, H. A. 1884a. The types of Tineina in the collection of the museum in Cambridge, Mass. *Papilio* 4: 96-99.
- _____. 1884b. The types of Tineina in the collection of the museum in Cambridge, Mass. No. II. *Papilio* 4: 151-154.
- Harrison, T. and S. Passoa. 1995. *Mirabilis*-feeding Heliodines (Lepidoptera: Heliodinidae) in central Illinois, with description of a new species. *Proc. Entomol. Soc. Wash.* 97: 63-70.
- Heinemann, H. 1877. Die Schmetterlinge Deutschlands und der Schweiz Systematisch Bearbeitet, Vol. 2:2. Braunschweig. 825 pp.
- Hennig, W. 1966. *Phylogenetic Systematics*. U. Illinois Press, Urbana. 263 pp.

- Heppner, J. B. 1982 ["1981"]. A world catalog of genera associated with the Glyphipterigidae auctorum (Lepidoptera). J. N.Y. Entomol. Soc. 89: 220-294.
- _____. 1984. Heliodinidae, p.57. *In*: J. B. Heppner (ed.), Atlas of Neotropical Lepidoptera. Checklist: Part 1, Micropterigoidea - Immoidea. W. Junk, Hague, Boston and Lancaster. xxvii + 112 pp.
- _____. 1987. Heliodinidae (Yponomeutoidea), pp. 410-411. *In*: F. W. Stehr (ed.), Immature Insects. Vol. 1. Kendall-Hunt, Dubuque. xiv + 754 pp.
- _____ and W. D. Duckworth. 1981. Classification of the superfamily Sesiioidea (Lepidoptera: Ditrysia). *Smithson. Contr. Zool.* 314. 144 pp.
- _____ and W. D. Duckworth. 1983. Heliodinidae, pp. 27-28. *In*: R. W. Hodges et al. (eds.), Check List of the Lepidoptera of North America North of Mexico. E. W. Classey and Wedge Entomol. Res. Found., London. xxiv + 284 pp.
- _____ and B. Landry. 1994. A new sun moth from the Galapagos Islands (Lepidoptera: Heliodinidae). *Trop. Lepid.* 5: 126-128.
- Hering, E. M. 1958. Neue Microlepidopteren von Tucuman. *Acta Zool. Lilloana* 15: 303-312.
- Hruby, 1964. *Prodromus Lepidoptera Slovaca*. Vydavatel'stvo Slovenskej Akadémie Vied, Bratislava. 926 pp.
- Hsu, Y.-F. 1995. Systematics of moths formerly assigned to *Heliodines* Stainton and phylogenetic relationships within Heliodinidae (Lepidoptera: Heliodinidae). Ph.D. Diss., U. California, Berkeley. 348 pp.
- _____. 2002. Larval and pupal biology of a new sun moth in southern California: Novel host use strategy in the evolution of Heliodinidae (Lepidoptera: Yponomeutoidea). *Pan-Pacific Entomol.* 78: 132-139.
- Hsu, Y.-F. and J. A. Powell 1997. The systematic position of *Heliodines loriculata* Meyrick (Yponomeutoidea: Heliodinidae). *Nota Lepid.* 20: 66-69.
- Karsholt, O. and E. S. Nielsen. 1976. Notes on some Lepidoptera described by Linnaeus, Fabricius, and Strom. *Entomol. Scand.* 7: 241-251.
- Kasy, F. 1976. _Über die Familienzugehörigkeit einiger "Heliodinidae"-Gattungen. *Ann. Naturhist. Mus. Wien.* 80: 415-430.
- Kelley, W. A. 1993. *Portulaca*, pp. 904-905. *In*: J. C. Hickman (ed.), *The Jepson*

- Manual, Higher Plants of California. U. of California Press, Berkeley and Los Angeles. xvii + 1400 pp.
- Kimball, C. P. 1965. Arthropods of Florida and Neighboring Land Areas. Div. Plant Industry, Fla. Dept. Agric., Gainesville. 363 pp.
- Kloet, G. S. and W. D. Hincks. 1972. A Check List of British Insects. Part 2: Lepidoptera. Handb. Ident. Brit. Insects. R. Entomol. Soc. London. viii + 153 pp.
- Klots, A. B. 1970. Lepidoptera, pp. 115-130. *In*: S. L. Tuxen (ed.), A Taxonomists' Glossary of Genitalia in Insects, 2nd ed. Munksgaard, Copenhagen. 359 pp.
- Kuroko, H. 1982. Lyonetiidae, pp. 172-176. *In*: H. S. Inoue et al. (eds.) Moths of Japan. Kodansha, Tokyo. 996 pp.
- Kyrki, J. 1983. Adult abdominal sternum II in the Ditrysiid tineoid superfamilies — morphology and phylogenetic significance (Lepidoptera). *Ann. Entomol. Fenn.* 49: 89-94.
- _____. 1984. The Yponomeutoidea: A reassessment of the superfamily and its suprageneric groups (Lepidoptera). *Entomol. Scand.* 15: 71-84.
- _____. 1990. Tentative classification of holarctic Yponomeutoidea (Lepidoptera). *Nota Lepid.* 13: 28-42.
- Kyrki, J. and J. Itamies. 1986. Immature stages and the systematic position of *Orthotelia sparganella* (Thunberg) (Lepidoptera: Yponomeutoidea). *Syst. Entomol.* 11: 93-105.
- Landry, J.-F. 1991. Systematics of Nearctic Scythrididae (Lepidoptera: Gelechioidea): Phylogeny and classification of supraspecific taxa, with a review of described species. *Mem. Entomol. Soc. Can.* 160: 1-341.
- Lhomme, L. 1963. Catalogue des Lépidoptères de France et de Belgique. Vol. II. Société entomologique de France. Le Carriol., pp. 489-1253.
- Lima, A. da Costa . 1936. Tercero Catalogo dos Insetos que Vivem nas Plantas do Brasil. Directoria Estat. Produc., Rio de Janeiro. 460 pp.
- _____. 1945. Insetos do Brasil. 5.º Tomo. Lepidopteros, 1.ª parte. Escola Nac. Agron., Série Didática 7. 379 pp.
- _____. 1968. Quarto Catalogo dos Insetos que Vivem nas Plantas do Brasil. Directoria Estat. Produc., Rio de Janeiro. 622 pp.

- Linnaeus, C. 1758. *Systema Naturae* (ed. 10). Tom. 1. Holmiae. 824 pp.
- Liu, H. L., T. S. Liu, T. C. Huang, T. Koyama, and C. E. Del Vol. 1976. *Flora of Taiwan*. Vol. II. Epoch Publ. Co., Taipei. 722 pp.
- Mabberley, D. J. 1987. *The Plant-Book*. Cambridge U. Press, Cambridge. 706 pp.
- Maddison, W. P., M. J. Donoghue, and D. R. Maddison. 1984. Outgroup analysis and parsimony. *Syst. Zool.* 33: 83-103.
- Meacham, C. A. 1981. A manual method for character compatibility analysis. *Taxon* 30: 591-600.
- Meyrick, E. 1881. Descriptions of Australian Micro-Lepidoptera. IV. Tineina. *Proc. Linn. Soc. N.S.W.* 5: 204-271.
- _____. 1895. *A Handbook of British Lepidoptera*. Macmillan, London. vi + 843 pp.
- _____. 1906. Descriptions of Australian Tineina. *Trans. R. Soc. So. Austral.* 30: 33-66.
- _____. 1907. Descriptions of Australian Micro-Lepidoptera. XIX. Plutellidae. *Proc. Linn. Soc. N.S.W.* 32: 47-150.
- _____. 1909. Descriptions of microlepidoptera from Bolivia and Peru. *Trans. Entomol. Soc. London*, 1909: 13-43.
- _____. 1912. Glyphipterygidae. *Exot. Microlep.* 1: 35-63.
- _____. 1913. Fam. Heliodinidae. *Lepidopterorum Catalogus* 13: 9-22.
- _____. 1914a. *Lepidoptera Heterocera*, Fam. Glyphipterygidae. *Genera Insectorum* 164: 1-39, 2 color pls.
- _____. 1914b. *Lepidoptera Heterocera*, Fam. Heliodinidae. *Genera Insectorum* 165: 1-29, 2 color pls.
- _____. 1915. Descriptions of South American Micro-Lepidoptera. *Trans. Entomol. Soc. London*, 1915: 201-256.
- _____. 1917. Heliodinidae. *Exot. Microlep.* 2: 61-66.
- _____. 1922. Heliodinidae. *Exot. Microlep.* 2: 584-588.

- _____. 1927. Microlepidoptera. Insects of Samoa 3, fasc. 2: 65-116.
- _____. 1930. Heliodinidae. Exot. Microlep. 3: 585-587.
- _____. 1932. Heliodinidae. Exot. Microlep. 4: 272-273.
- _____. 1936. New species of Pyrales and Microlepidoptera. Arb. morph. taxon. Entomol, Berlin-Dahlem 3: 94-109.
- _____. 1937. Heliodinidae. Exot. Microlep. 5: 150.
- Miller, S. E. and R. W. Hodges. 1990. Primary types of microlepidoptera in the Museum of Comparative Zoology (with a discussion on V. T. Chambers' work). Bull. Mus. Comp. Zool. 152: 45-87.
- Minet, J. 1983. Étude morphologique et phylogénéétique des organes tympaniques des Pyraloidea. 1 - Généralités et homologues. (Lep Glossata). Ann. Soc. entomol. France 19: 175-207.
- _____. 1991. Tentative reconstruction of the ditrysian phylogeny (Lepidoptera: Glossata). Entomol. Scand. 22: 69-95.
- Mishler, B. D. and E. Theriot. 2000. The phylogenetic species concept (*sensu* Mishler and Theriot): Monophyly, apomorphy, and phylogenetic species concepts. In: Q. D. Wheeler and R. Meier (eds.), Species Concepts and Phylogenetic Theory: A Debate. Columbia U. Press, New York.. xii + 230 pp.
- Monte, O. 1934. Borboletas que vivem em plantas cultivadas. Bol. Agric. Zootechnica Veterinaria, Estado Minas Gerais 7: 1-219.
- Morris, F. O. 1870. A Natural History of British Moths. Vol. IV. Longmans, London. 304 pp.
- Moriuti, S. 1982. Heliodinidae. pp. 232-233. In: H. Inoue, et al. (eds.), A. Moths of Japan, Kodansha, Tokyo. 996 pp.
- Nielsen, E. S. and I. B. F. Common. 1991. Lepidoptera (Moths and Butterflies). Chap. 41, pp. 817-915. In: The Insects of Australia: A Textbook for Students and Research Workers. Vol. 2, pp. 543-1137. C.S.I.R.O. (Div. Entomol.); Melbourne U. Press and Cornell U. Press, Ithaca.
- Nye, I. W. B. and D. S. Fletcher. 1991. The Generic Names of Moths of the World.

Vol. 6. Microlepidoptera. Nat. Hist. Mus. Publ., London. xxix + 368 pp.

Pierce, F. N. and J. W. Metcalfe. 1935. The Genitalia of the Tineid Families of the Lepidoptera of the British Islands. F. N. Pierce, Warmington; Oundle, Northants. 114 pp.

Powell, J. A. 1964. Biological and taxonomic studies on tortricine moths, with reference to the species in California. U. Calif. Publ. Entomol. 32: 1-307.

_____. 1980. Evolution of larval food preferences in microlepidoptera. Annual Rev. Entomol. 25: 133-159.

_____. 1991. A review of *Lithariapteryx* (Heliodinidae), with description of an elegant new species from coastal sand dunes in California. J. Lepid. Soc. 45: 89-104.

Powell, J. A., C. Mitter, and B. Farrell. 1999. Chap. 20. Evolution of larval food preferences in Lepidoptera, Moths and Butterflies, pp. 403-422. *In*: Kristensen, N. (ed.) Handbook of Zoology, Lepidoptera. Vol. 1, Evolution, Systematics, and Biogeography. W. de Gruyter, Berlin, New York. x + 487 pp.

Robinson, G. S. and E. S. Nielsen. 1996. Tineidae. Monogr. Austral. Lepid. 4: 37-42.

Scoble, M. J. 1992. The Lepidoptera. Oxford U. Press, Oxford. 404 pp.

Skalski, A. W. 1976. Les lépidoptères fossiles de l'ambre. Etat actuel de nos connaissances (2^e partie). Linneana Belgica 6: 195-208.

Skalski, A. W. 1977. Studies on the Lepidoptera from fossil resins, Part I, general remarks and descriptions of new genera and species of the families Tineidae and Oecophoridae from the Baltic amber. Prace Muzeum Ziemi Z. 26: 3-24.

Smithe, F. B. 1975. Naturalists' Color Guide. Am. Mus. Nat. Hist., New York. 11 pp.

Snellen, P. C. T. 1882. De Vlinders van Nederland. E. J. Brill, Leiden. 1196 pp.

Stainton, H. T. 1854. Insecta Britannica Lepidoptera: Tineina. Lovell Reeve, London. 313 pp. + 10 pls.

_____. 1859. A Manual of British Butterflies and Moths. Vol. II. John Van Voorst, London. 480 pp.

Stehr, F. W. 1987. Order Lepidoptera, pp. 288-340. *In*: F. W. Stehr (ed.), Immature Insects. Vol. 1. Kendall-Hunt, Dubuque. xiv + 754 pp.

- Stevens, P. F. 1980. Evolutionary polarity of character states. *Annual Rev. Ecol. Syst.* 11: 333-358.
- Swofford, D. L. 1991. *Phylogenetic Analysis Using Parsimony*. Version 3.0s. Illinois Nat. Hist. Survey. 182 pp.
- Thorne, R. F. 1981. Phytochemistry and angiosperm phylogeny, a summary statement, pp. 233-295. *In*: D. A. Young and D. S. Seigler (eds.), *Phytochemistry and Angiosperm Phylogeny*. Praeger, New York.
- Turner, A. J. 1941. A revision of the Australian Heliodinidae (Lepidoptera). *Trans. R. Soc. So. Austral.* 65: 14-27.
- Vrana, P. and W. Wheeler. 1992. Individual organisms as terminal entities: Laying the species problem to rest. *Cladistics* 8: 67-72.
- Walker, E. H. 1976. *Flora of Okinawa and the Southern Ryukyu Islands*. Smithsonian Institution Press, Washington, D.C.; 1159 pp.
- Walsingham, T. 1881. On some North-American Tineidae. *Proc. Zool. Soc. London* 1881: 301-325.
- _____. 1892a. Micro-Lepidoptera of the West Indies. *Proc. Zool. Soc. London* 1891: 492-548.
- _____. 1892b. Steps towards a revision of Chambers's Index, with notes and description of new species. *Insect Life* 4: 384-385.
- _____. 1897. Revision of the West-Indian Micro-Lepidoptera, with descriptions of new species. *Proc. Zool. Soc. London* 1897: 54-183.
- _____. 1909-1915. Lepidoptera-Heteroptera. Vol. 4. Tineina, Pterophorina, Orneodina, and Pyralidina and Hepialidina (part). *In*: F. Godman and O. Salvin (eds.), *Biologia Centrali- Americana, Insecta*. 482 pp. + 10 color pls.
- Wester, C. 1956. Comparative bionomics of two species of *Heliodines* on Mirabilis. *Proc. Entomol. Soc. Wash.* 58: 43-36.
- Wiley, E. O. 1981. *Phylogenetics: The Theory and Practice of Phylogenetic Systematics*. Wiley and Sons, New York. 439 pp.
- Wolcott, G. N. 1936. "Insectae Borinquensis," a revised annotated check-list of the

insects of Puerto Rico. *J. Agric., U. Puerto Rico*, 20: 1-600.

Zimsen, E. 1964. *The Type Material of I. C. Fabricius*. Munksgaard, Copenhagen. 656 pp.

Figures 26-220

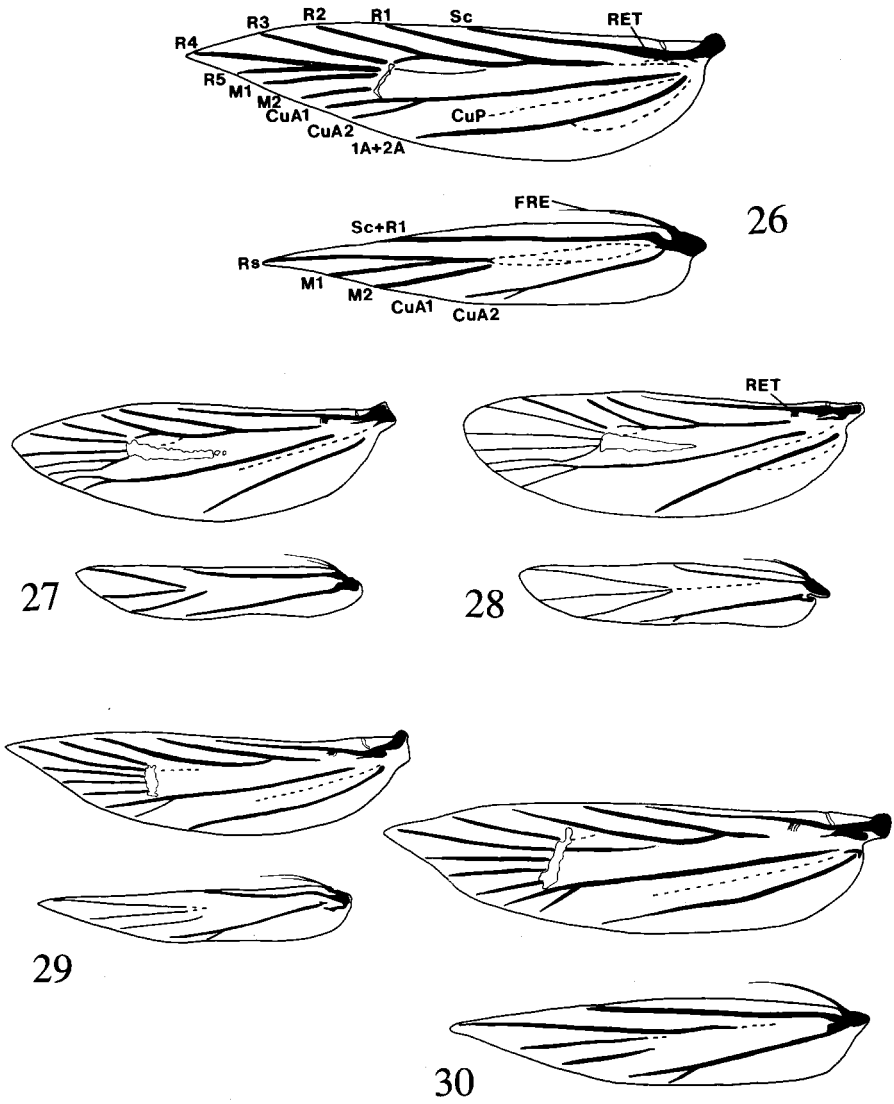

Figs. 26-30. Wing venation of Heliodinidae: 26, *Heliodines roesella*; 27, *Epicroesa metallifera*; 28, *Philocoristis catachalca*; 29, *Lamprolophus lithella*; 30, *Lithariapteryx abroniaeella*. Abbreviations: A = anal; Cu = cubital; FRE = frenulum; M = medial; R = radial; RET = retinaculum; Sc = subcostal.

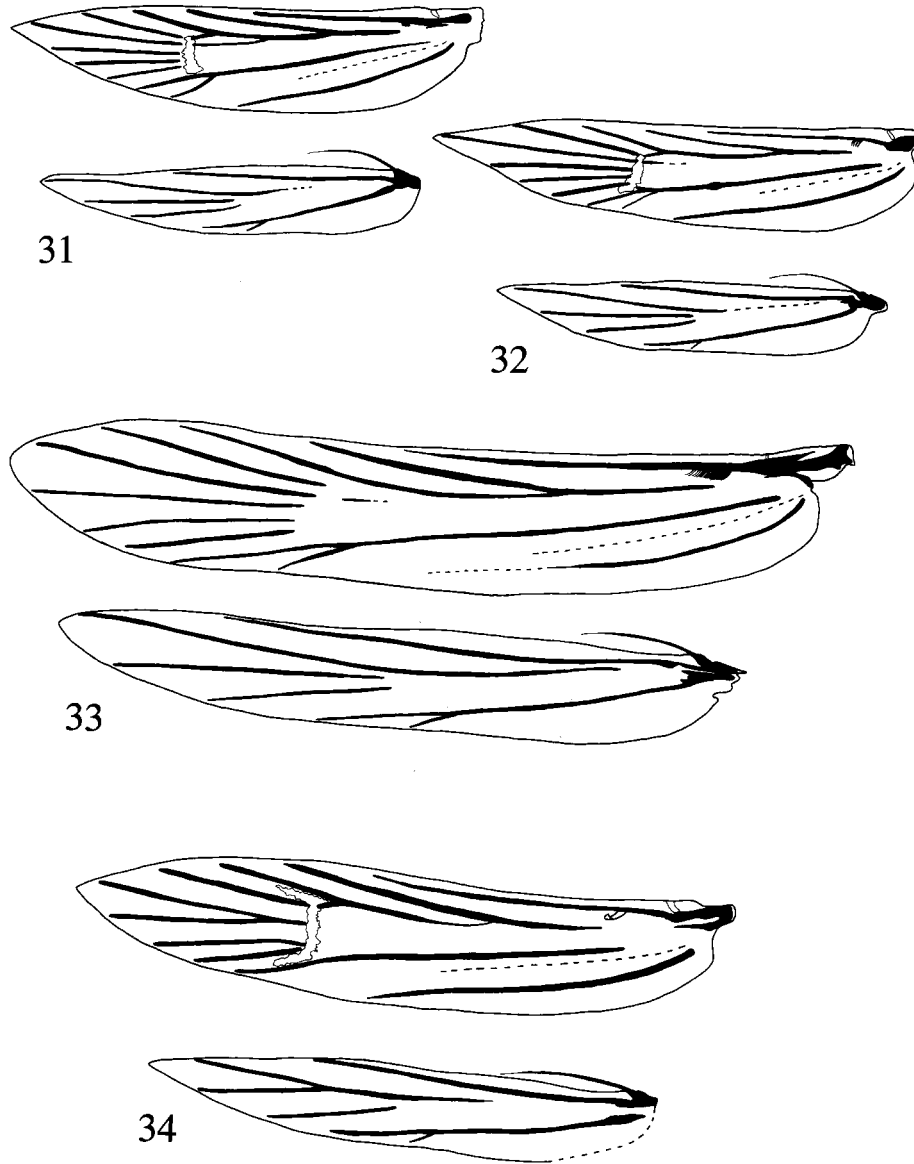

Figs. 31-34. Wing venation of Heliodinidae: 31, *Neoheliodines nyctaginella*; 32, *Embola ionis*; 33, *Heliogemma gigantea*; 34, *Pseudastasia opulenta*.

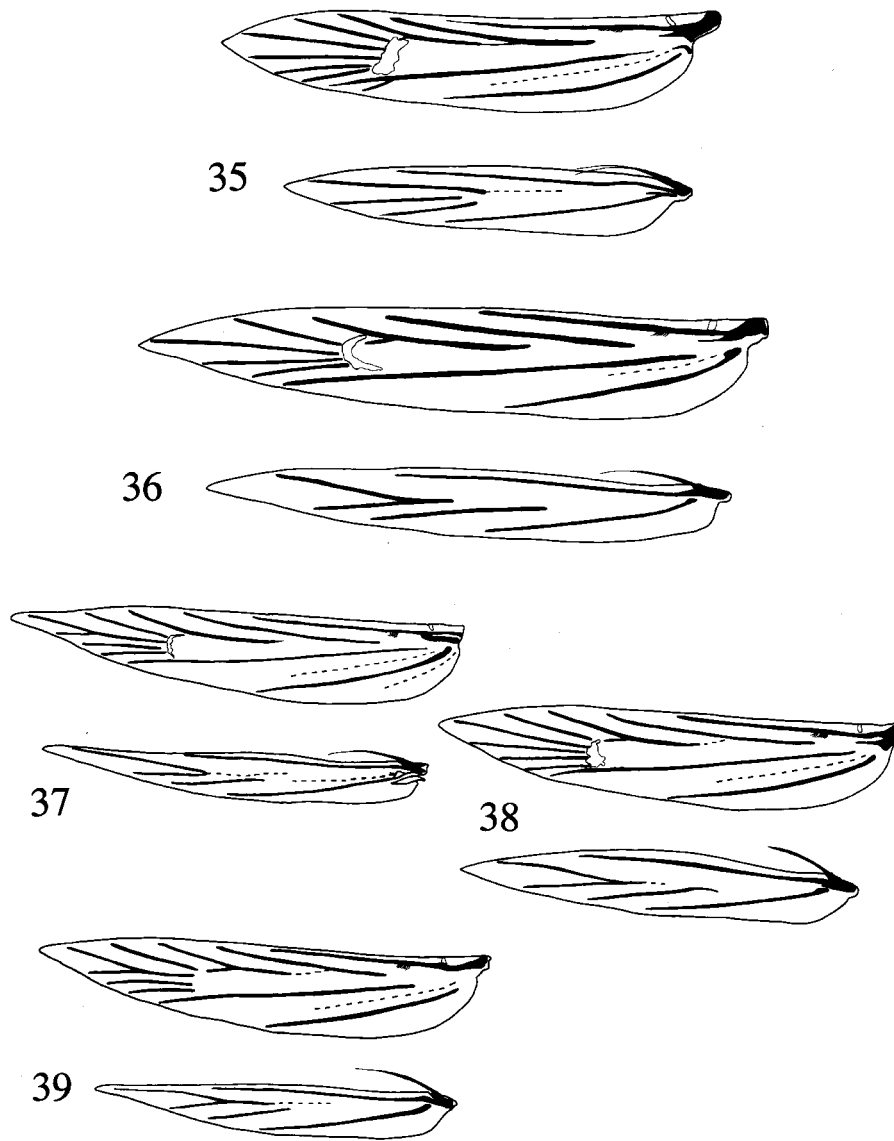

Figs. 35-39. Wing venation of Heliodinidae: 35, *Euheliodines chemsaki*; 36, *Aetole eximia*; 37, *A. bella*; 38, *A. tripunctella*; 39, *A. extraneella*.

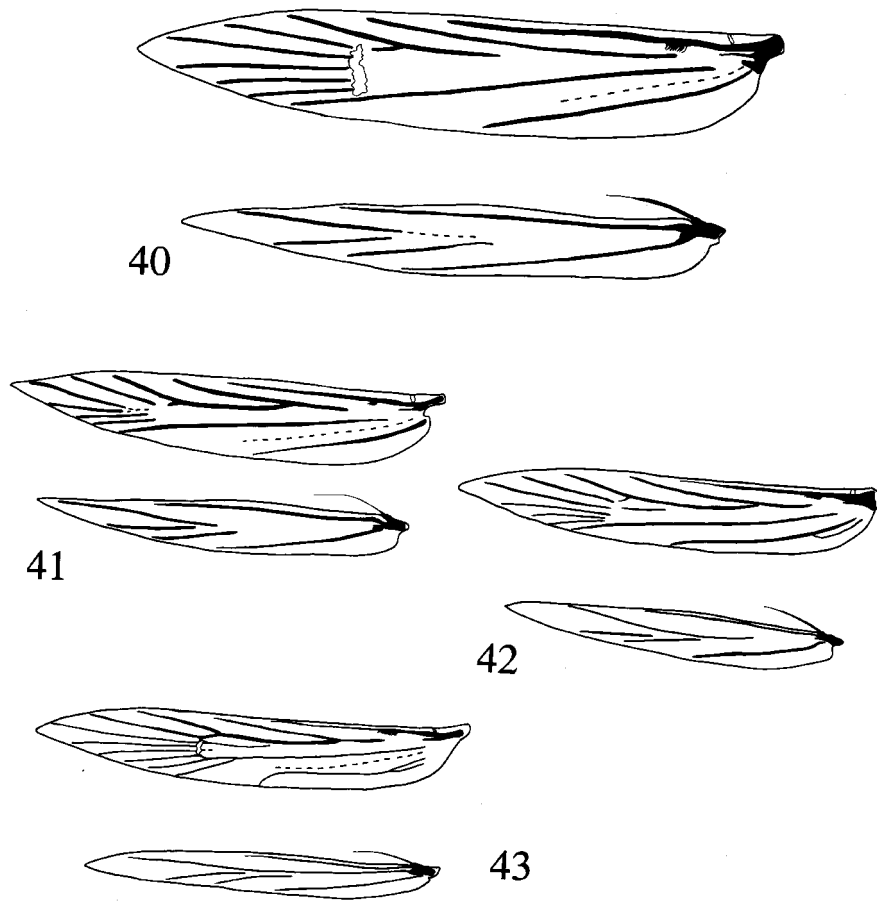

Figs. 40-43. Wing venation of Heliodinidae: 40, *Aetole calcifer*; 41, *A. galapagoensis*; 42, *Scelorthus pisoniella*; 43, *Copocentra* undetermined species.

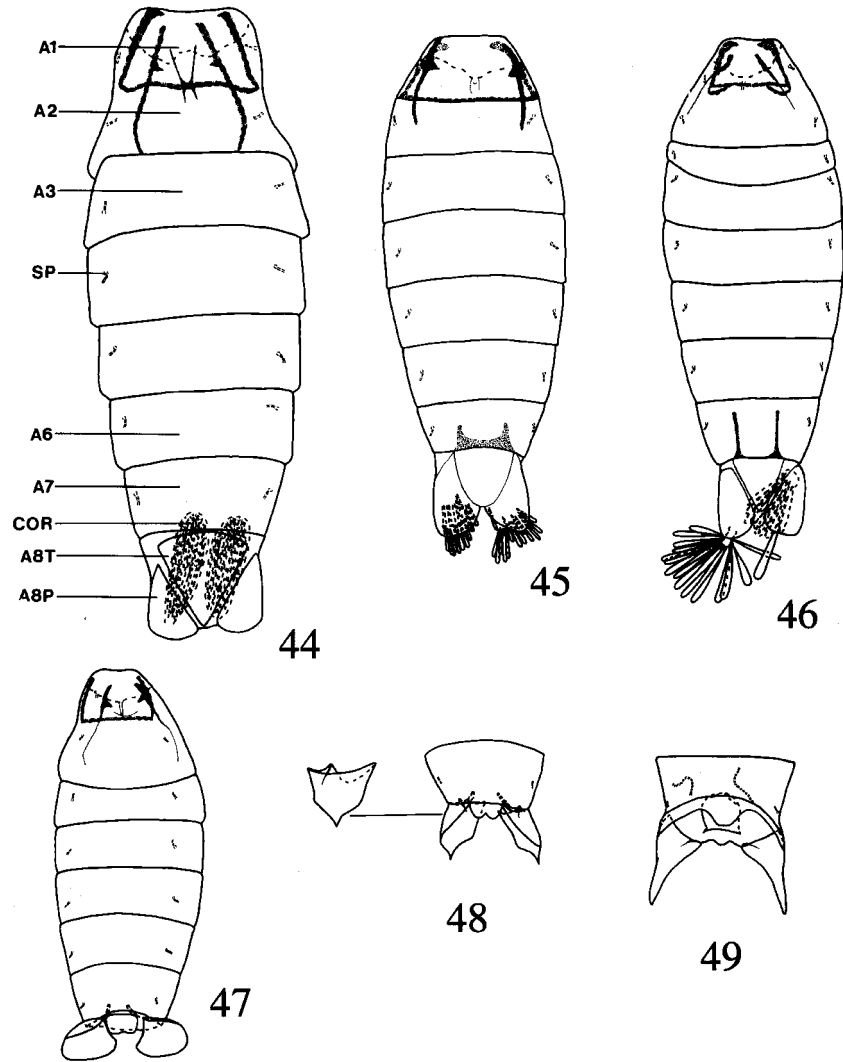

Figs. 44-49. Abdominal structures of Heliodinidae, dorsal aspect: 44, *Embola cyanozostera*; 45, *Neoheliodines nyctaginella*; 46, *Scelorthus pisoniella*; 47, *Aetole bella*; 48, *A. prenticei* (A7 and A8, pleural lobe lateral aspect to left); 49, *A. eximia* (A7 and A8). Abbreviations: A1-A8 = abdominal segments 1-8; T = tergum; P = pleuron; SP = spiracle; COR = coremata.

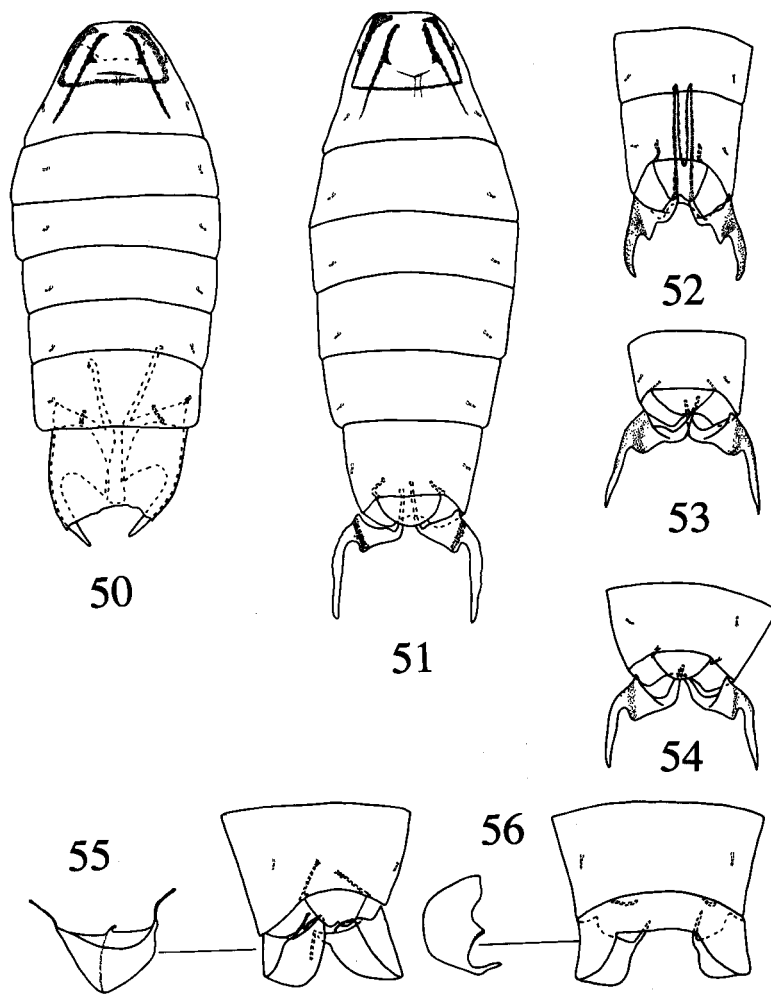

Figs. 50-56. Abdominal structures of Heliodinidae, dorsal aspect: 50, *Aetole extraneella*; 51, *A. tripunctella*; 52, *A. unipunctella* (A6-A8); 53, *A. cera* (A7 and A8); 54, *A. favonia* (A7 and A8); 55, *A. calcifer* (A7 and A8, pleural lobe lateral aspect to left); 56, *A. galapagoensis* (A7 and A8, pleural lobe lateral aspect to left).

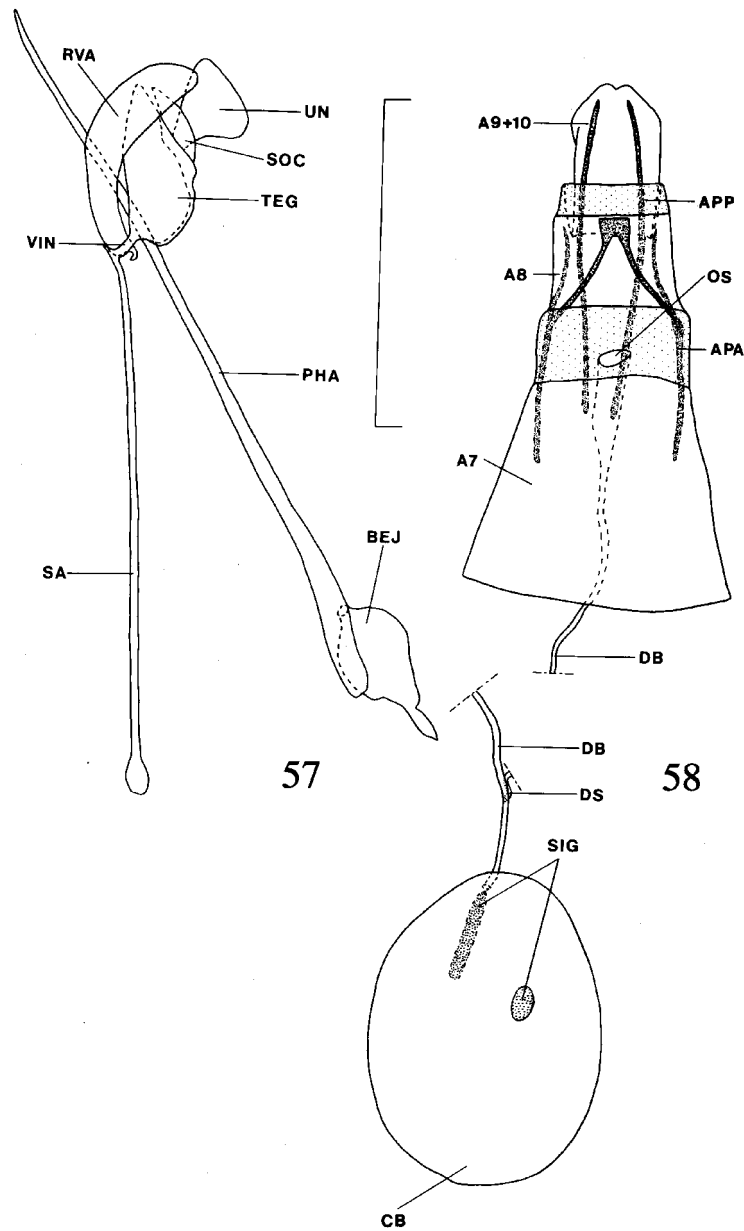

Figs. 57-58. Genitalia characteristics of Heliodinidae: 57, male, lateral aspect, phallus in situ. Abbreviations: BEJ = *bulbus ejaculatorius* (phallobase); PHA = *phallus* (*aedeagus*); RVA = *right side valva*; SA = *saccus*; SOC = *socius*; TEG = *tegumen*; VIN = *vinculum*. 58, female, ventral aspect, middle portion of ductus bursae not shown. Abbreviations: A7-A9+10 = abdominal segments; APA = *anterior apophysis*; APP = *posterior apophysis*; CB = *corpus bursae*; DB = *ductus bursae*; DS = base of *ductus seminalis*; OS = *ostium*; SIG = *signa*.

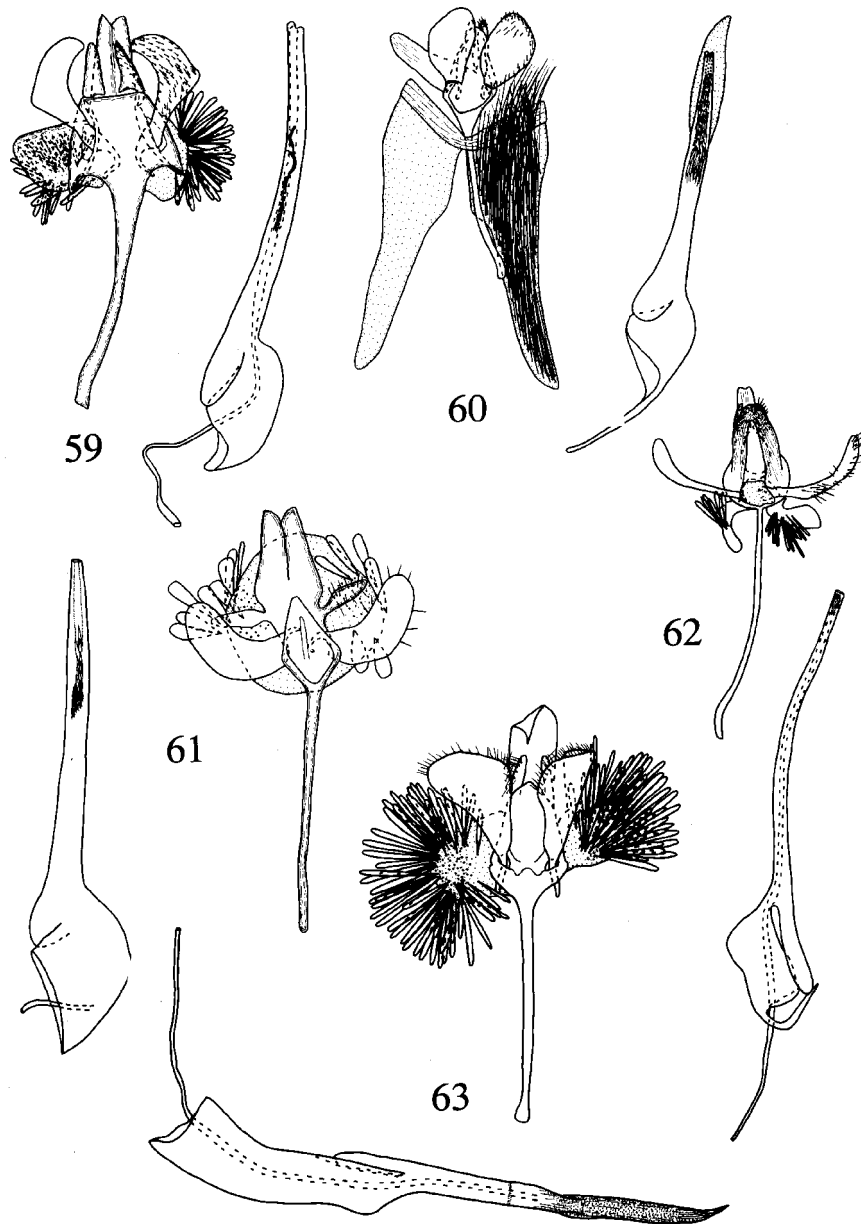

Figs. 59-63. Male genitalia of Heliodinidae, ventral aspect, valvae spread, aedeagus removed: 59, *Heliodines roesella*, aedeagus to right; 60, *Epicroesa metallifera*, aedeagus to right; 61, *Philocoristis catachalca*, aedeagus to left; 62, *Lamprolophus lithella*, aedeagus to right; 63, "*Heliodines*" *princeps*, aedeagus below.

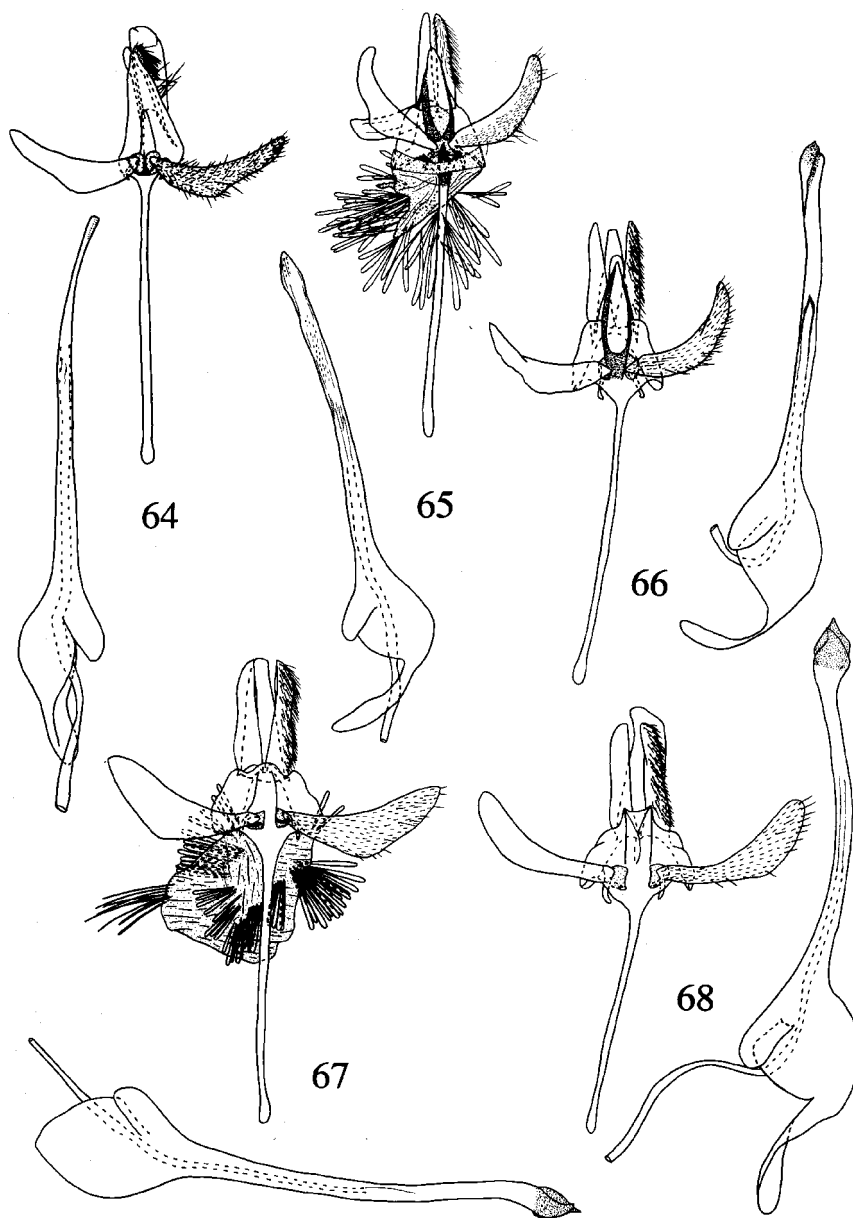

Figs. 64-68. Male genitalia of Heliodinidae, ventral aspect, valvae spread, aedeagus removed: 64, *Lithariapteryx abroniaeella*, aedeagus to left; 65, *Neoheliodines nyctaginella*, aedeagus to left; 66, *N. eurypterus*, aedeagus to right; 67, *N. hodgesi*, aedeagus below; 68, *N. megostiellus*, aedeagus to right.

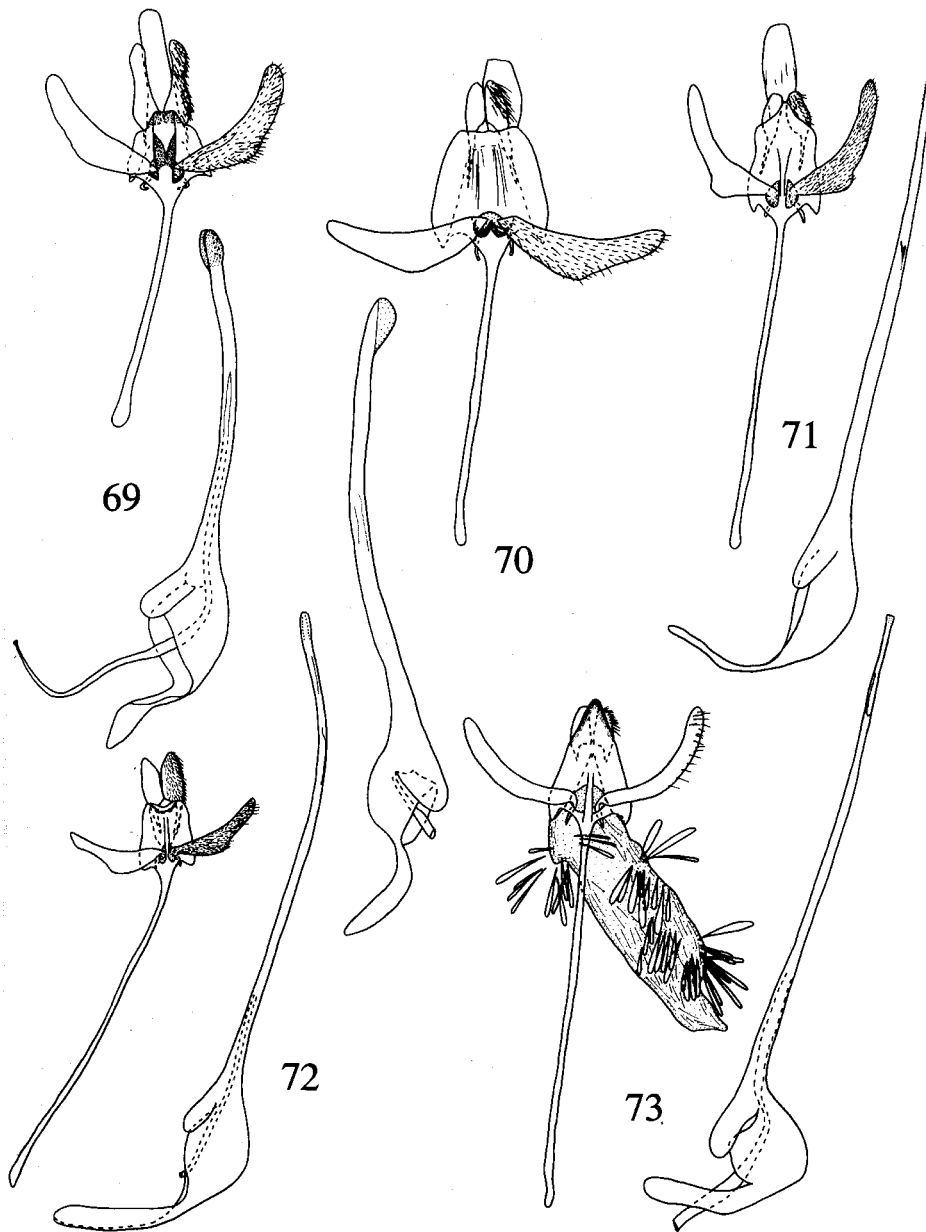

Figs. 69-73. Male genitalia of *Neoheliodines*, ventral aspect, valvae spread, aedeagus removed: 69, *N. melanobasilarus*, aedeagus to right; 70, *N. vernius*, aedeagus to left; 71, *N. cliffordi*, aedeagus to right; 72, *N. arizonense*, aedeagus to right; 73, *N. albidus*, aedeagus to right.

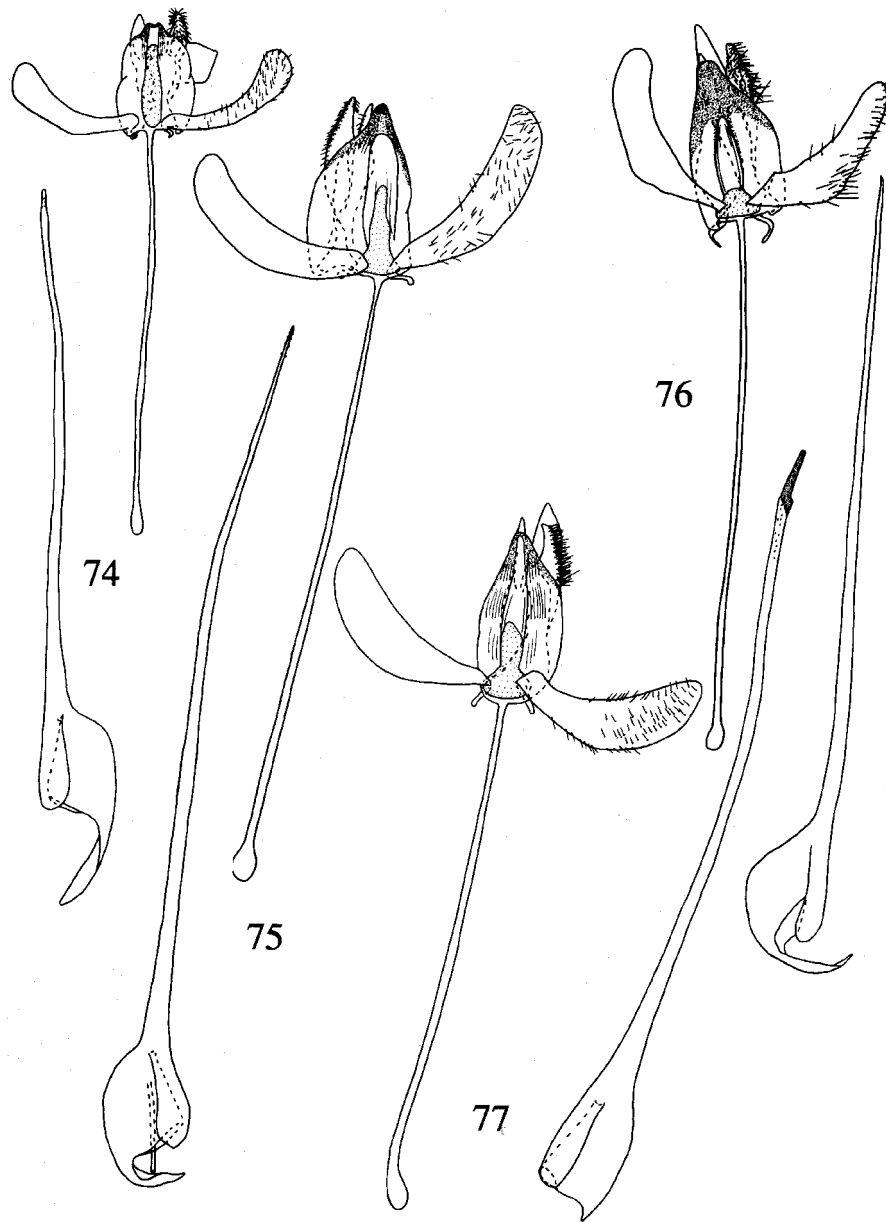

Figs. 74-77. Male genitalia of *Embola*, ventral aspect, valvae spread, aedeagus removed: 74, *E. ionis*, aedeagus to left; 75, *E. ciccella*, aedeagus to left; 76, *E. cyanozostera*, aedeagus to right; 77, *E. albaciliella*, aedeagus to right.

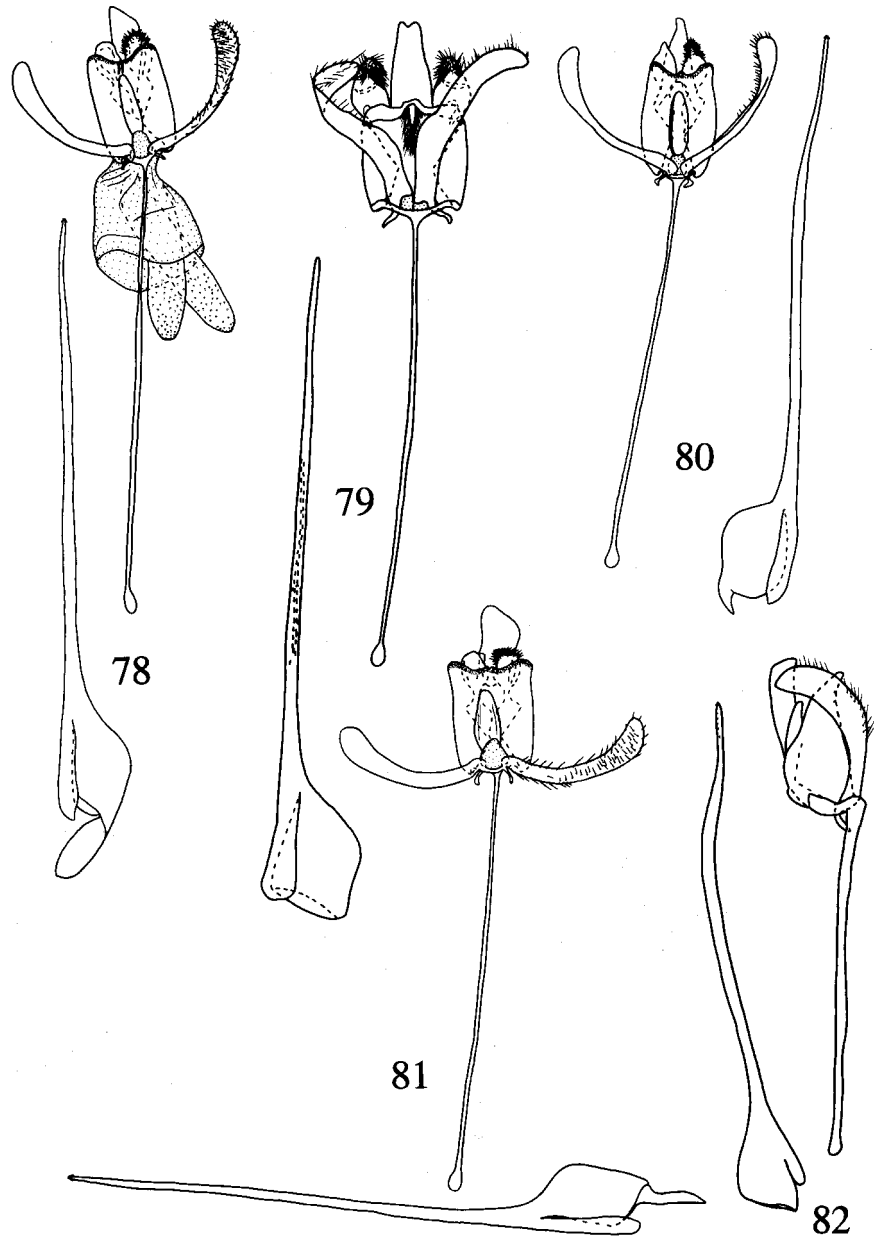

Figs. 78-82. Male genitalia of *Embola*, ventral aspect, valvae spread, aedeagus removed: 78, *E. friedlanderi*, aedeagus to left; 79, *E. erythorma*, aedeagus to left; 80, *E. melanotela*, aedeagus to right; 81, *E. autumnalis*, aedeagus below; 82, *E. sexpunctella*, lateral aspect, aedeagus to left.

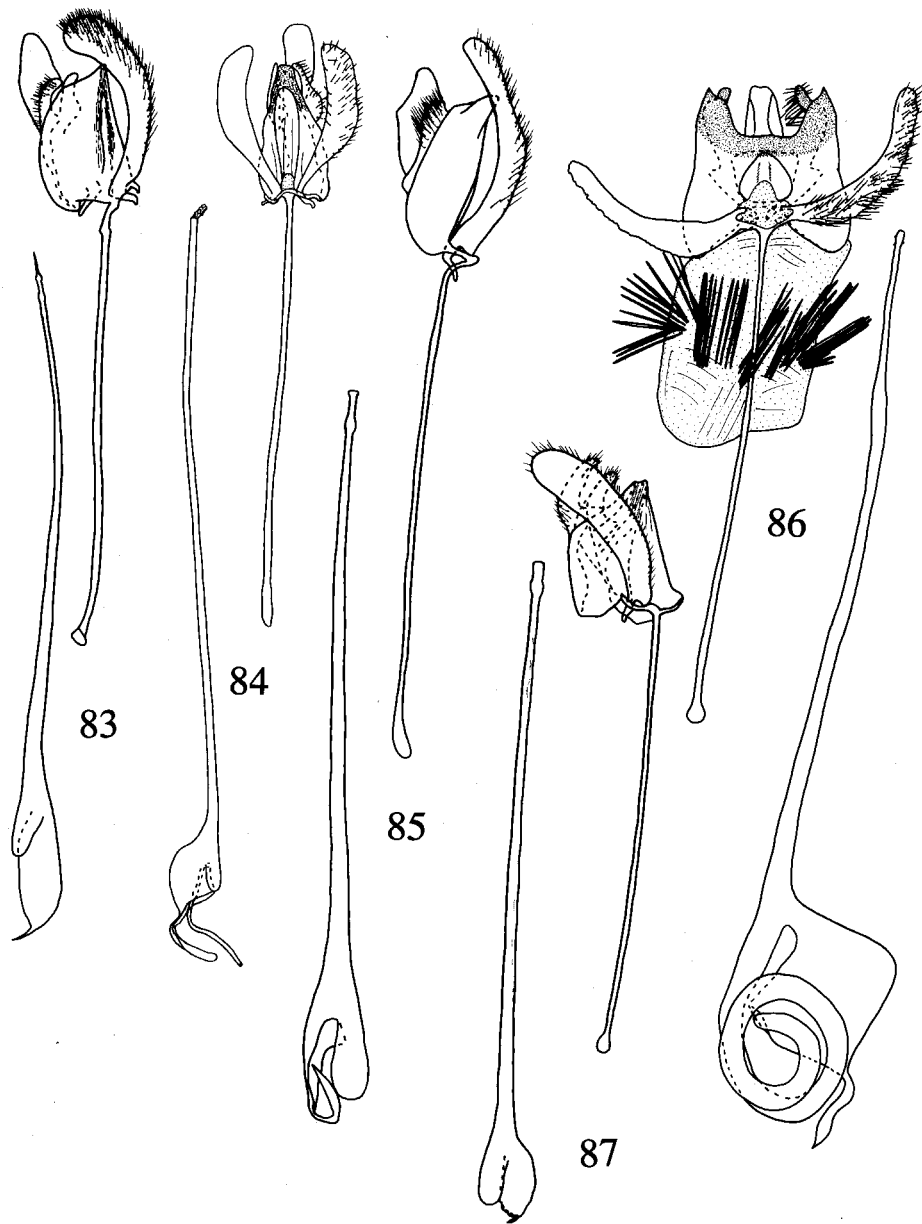

Figs. 83-87. Male genitalia of Heliodinidae, aedeagus removed: 83, *Embola dentifer*, lateral aspect, aedeagus to left; 84, *E. powelli*, ventral aspect, aedeagus to left; 85, *E. xanthocephala*, lateral aspect, aedeagus to left; 86, *Heliogemma gigantea*, ventral aspect, aedeagus to right; 87, *Pseudastasia opulenta*, lateral aspect, aedeagus to left.

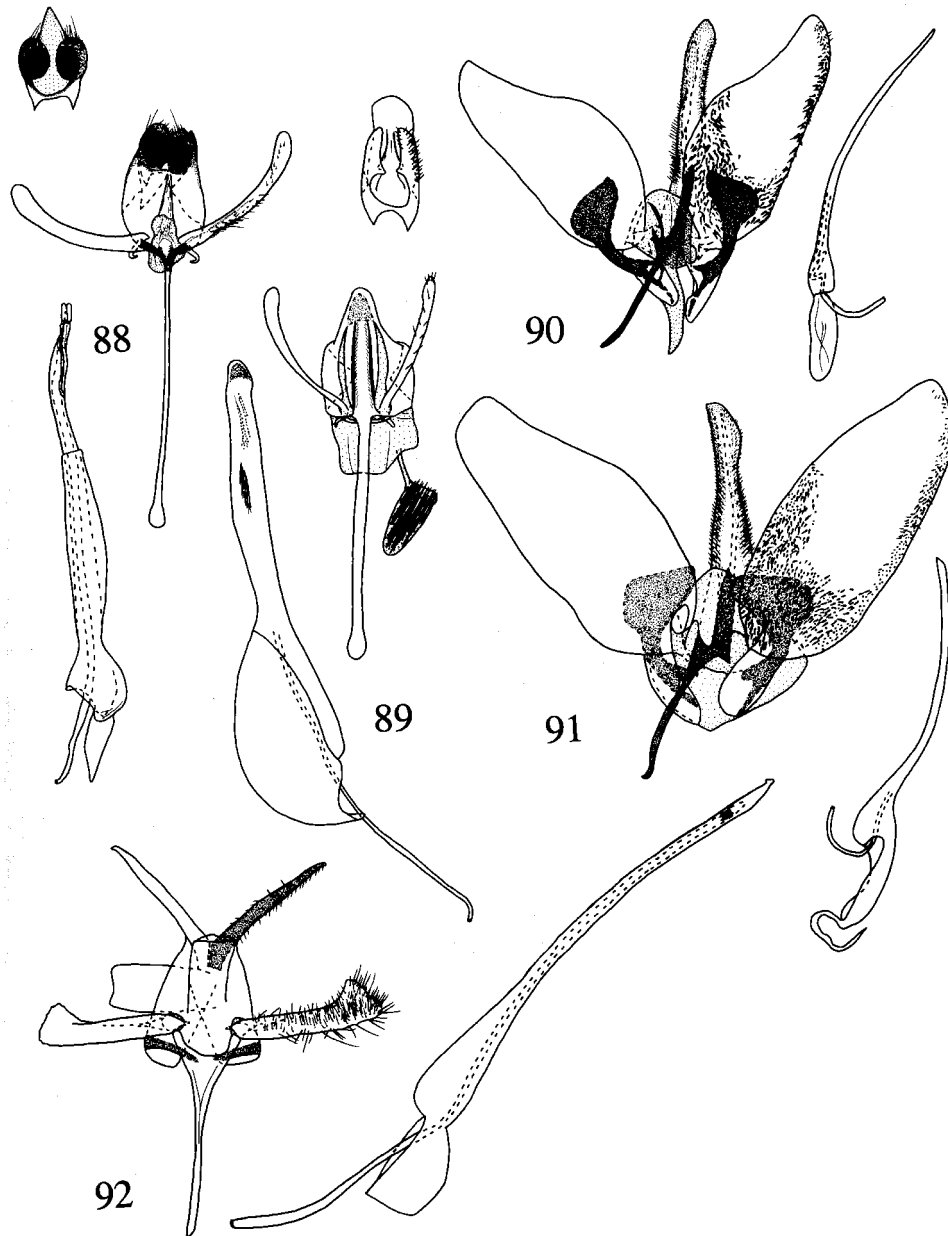

Figs. 88-92. Male genitalia of Heliodinidae, ventral aspect, valvae spread, aedeagus removed: 88, *Euheliodines chemsaki*, detail of uncus and socii above (anterior attenuate, lateral projections are the points of weak attachment to the tegumen dorsally), aedeagus to left; 89, *E. jaliscella*, detail of uncus and socii above, aedeagus to left; 90, *Aetole eximia*, aedeagus to right; 91, *A. insolita*, aedeagus to right; 92, *A. bella*, aedeagus to right.

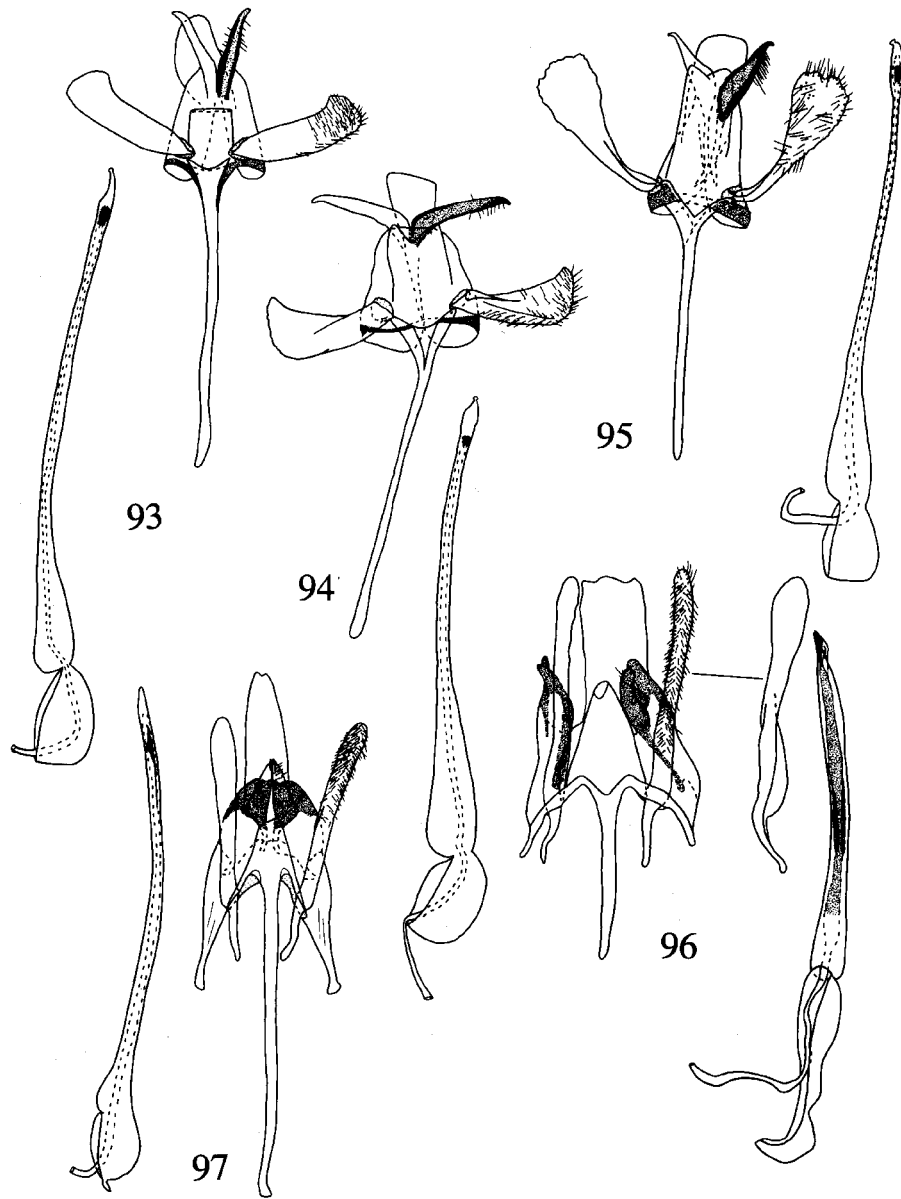

Figs. 93-97. Male genitalia of *Aetole*, ventral aspect, valvae spread, aedeagus removed: 93, *A. schulzella*, aedeagus to left; 94, *A. fulgida*, aedeagus to right; 95, *A. prenticei*, aedeagus to right; 96, *A. tripunctella*, valva in lateral aspect to right, aedeagus to right; 97, *A. unipunctella*, aedeagus to left.

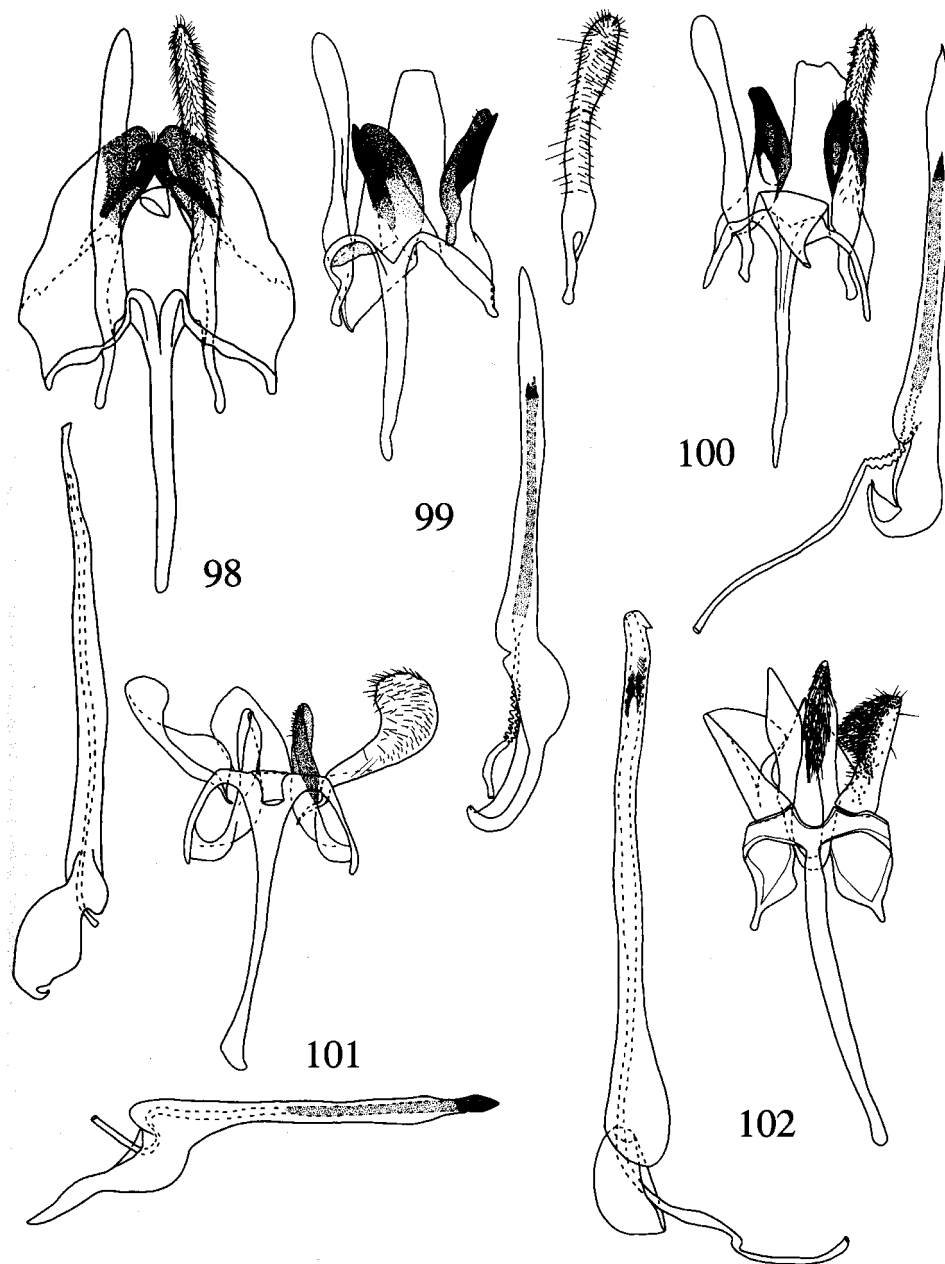

Figs. 98-102. Male genitalia of *Aetole*, ventral aspect, valvae spread, aedeagus removed: 98, *A. aprica*, aedeagus to left; 99, *A. cera*, valva in lateral aspect to right, aedeagus below, right; 100, *A. favonia*, aedeagus to right; 101, *A. extraneella*, aedeagus below; 102, *A. calcifer*, aedeagus to left.

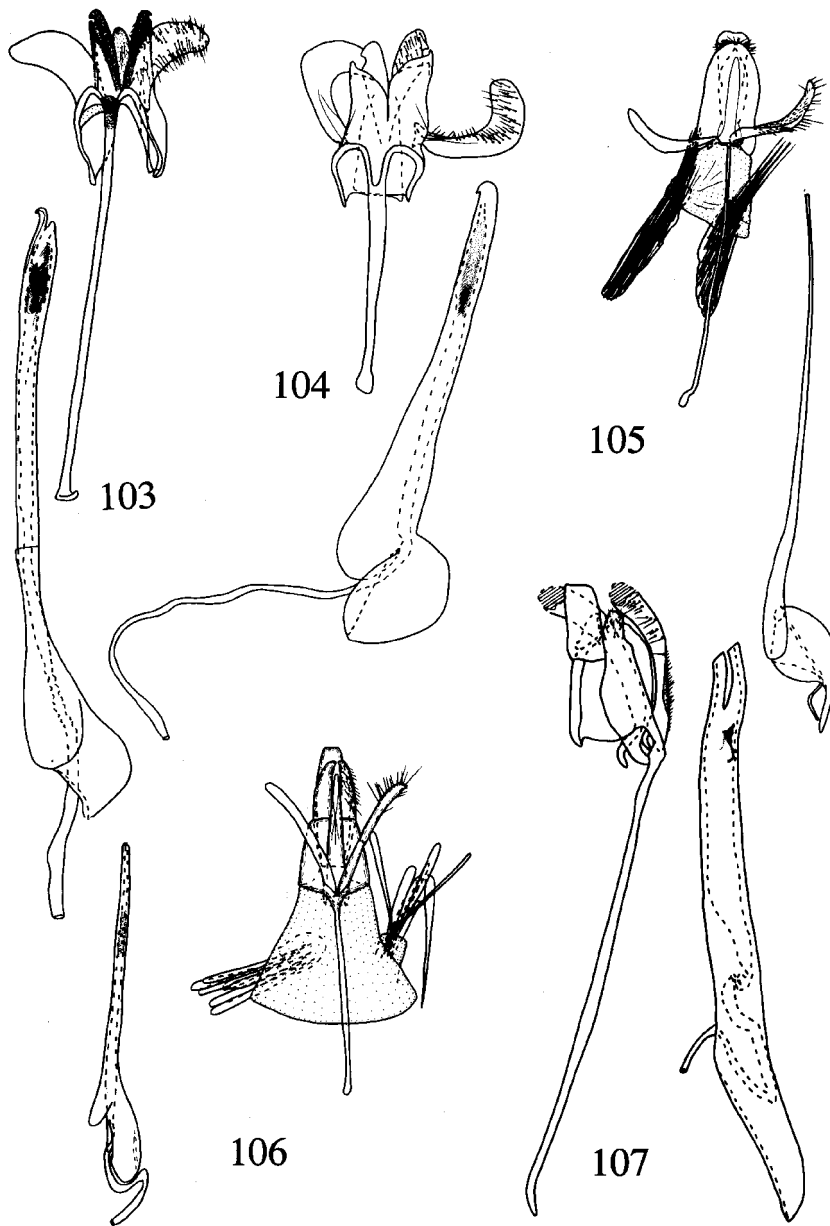

Figs. 103-107. Male genitalia of Heliodinidae, ventral aspect, valvae spread, aedeagus removed: 103, *Aetole calciferoides*, aedeagus below, left; 104, *A. galapagoensis*, aedeagus below, right; 105, *Copocentra* species, aedeagus below, right; 106, *Scelorthus pisoniella*, aedeagus to left; 107, "*Heliodines*" *marginata*, lateral aspect, aedeagus to right.

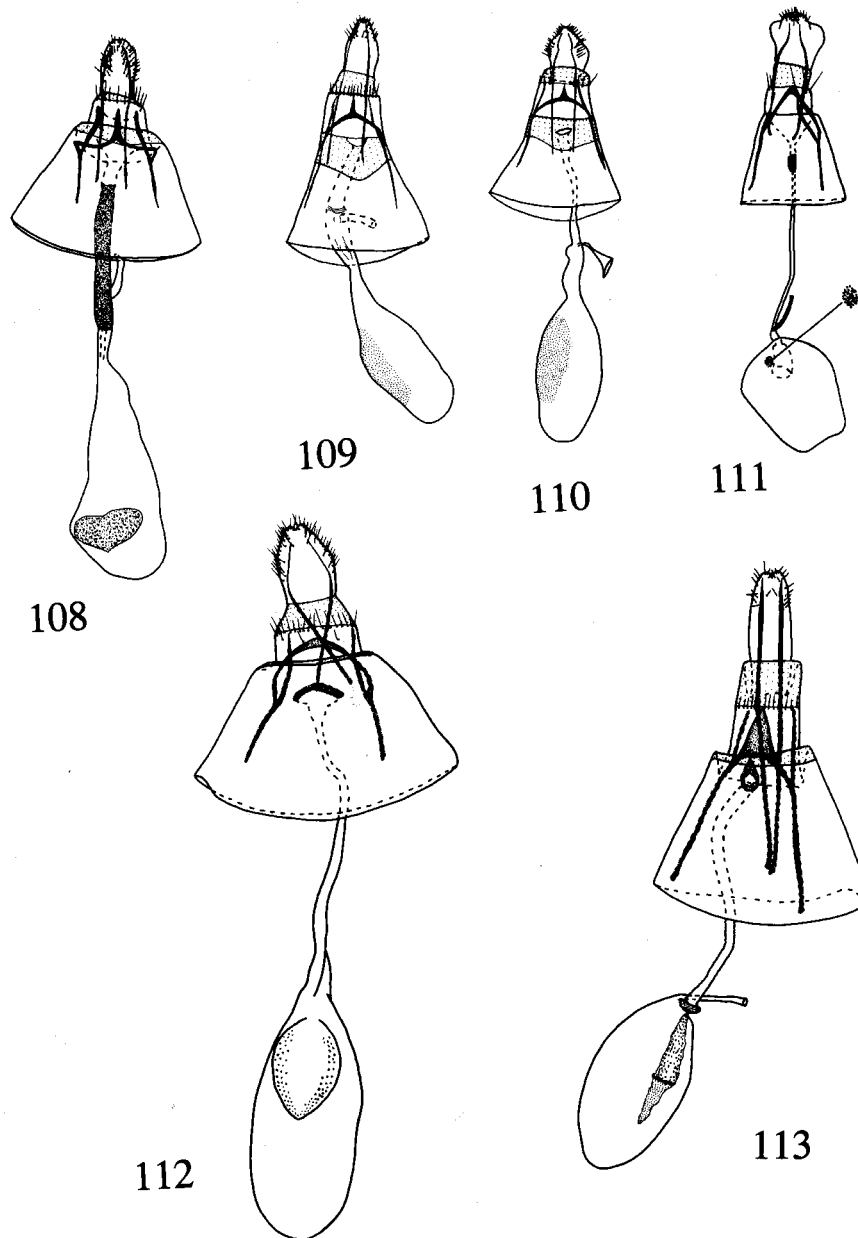

Figs. 108-113. Female genitalia of Heliodinidae, ventral aspect: 108, *Heliodines roesella*; 109, *Epicroesa metallifera*; 110, *Philocoristis catachalca*; 111, *Lamprolophus lithella*; 112, "*Heliodines*" *princeps*; 113, *Lithariapteryx abroniaella*.

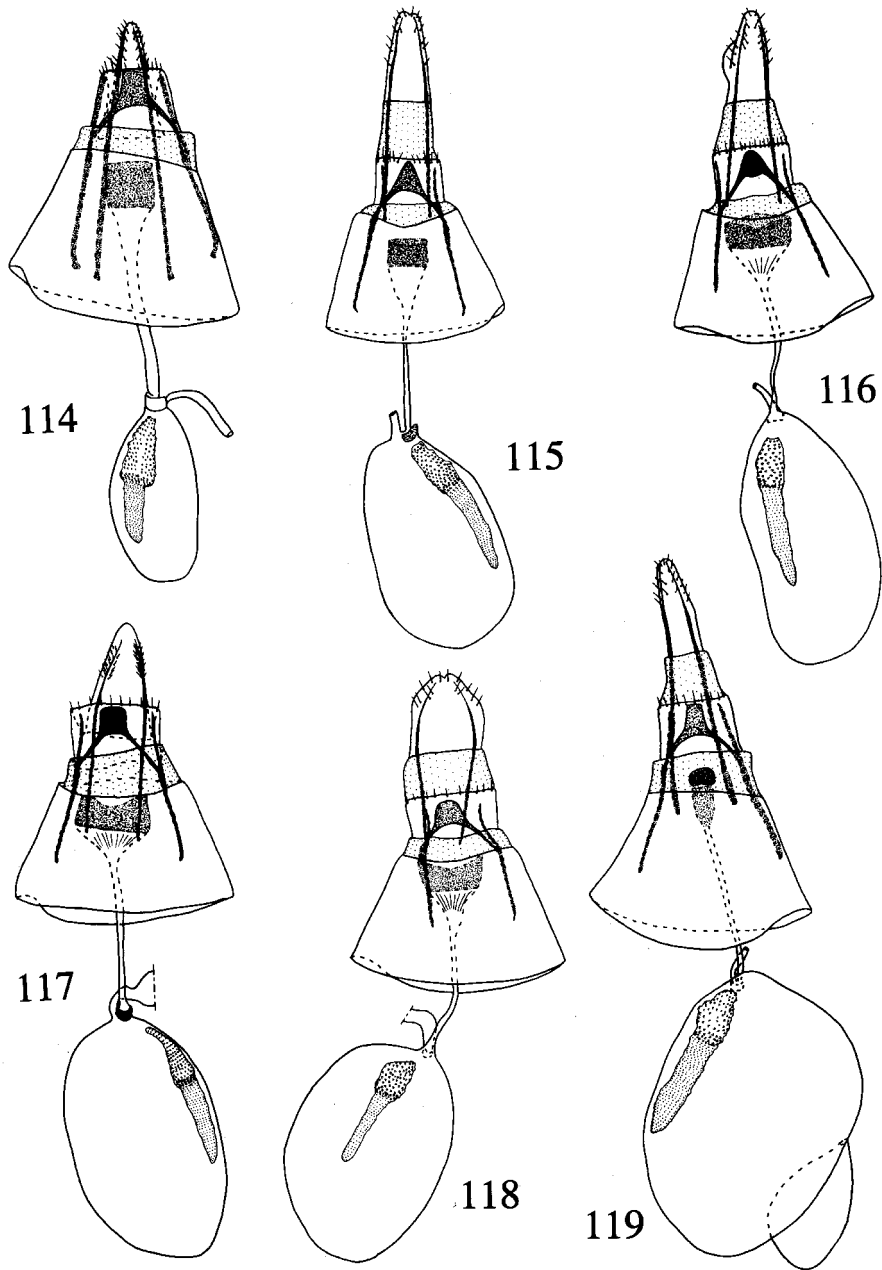

Figs. 114-119. Female genitalia of *Neoheliodines*, ventral aspect: 114, *N. nyctaginella*; 115, *N. eurypterus*; 116, *N. hodgesi*; 117, *N. megostiellus*; 118, *N. melanobasilarus*; 119, *N. vernius*.

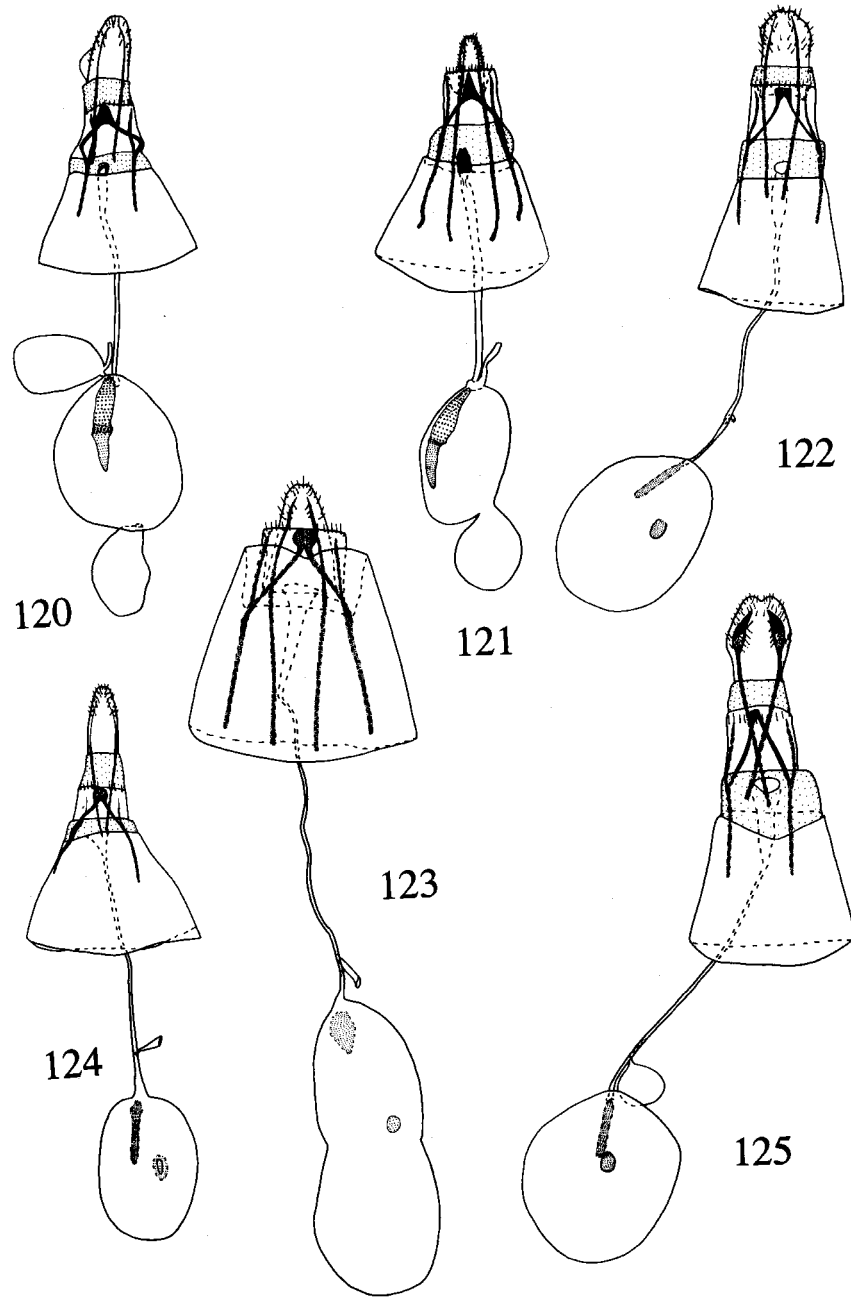

Figs. 120-125. Female genitalia of Heliodinidae, ventral aspect: 120, *Neoheliodines cliffordi*; 121, *N. arizonense*; 122, *Embola ionis*; 123, *E. ciccella*; 124, *E. cyanozostera*; 125, *E. friedlanderi*.

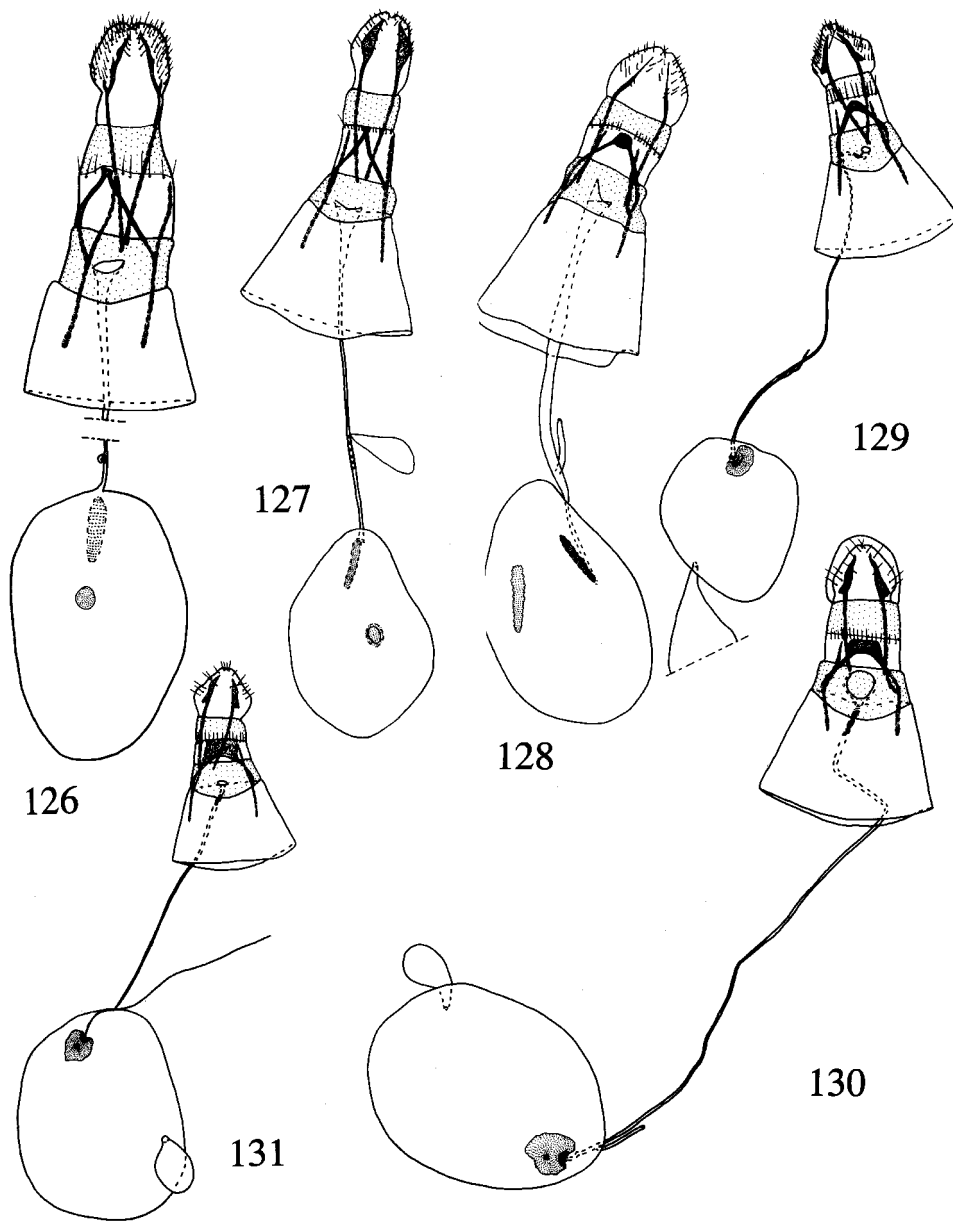

Figs. 126-131. Female genitalia of Heliodinidae, ventral aspect: 126, *Embola erythorma*; 127, *E. melanotela*; 128, *E. powelli*; 129, *Heliogemma gigantea*; 130, *H. grandis*; 131, *H. preclara*.

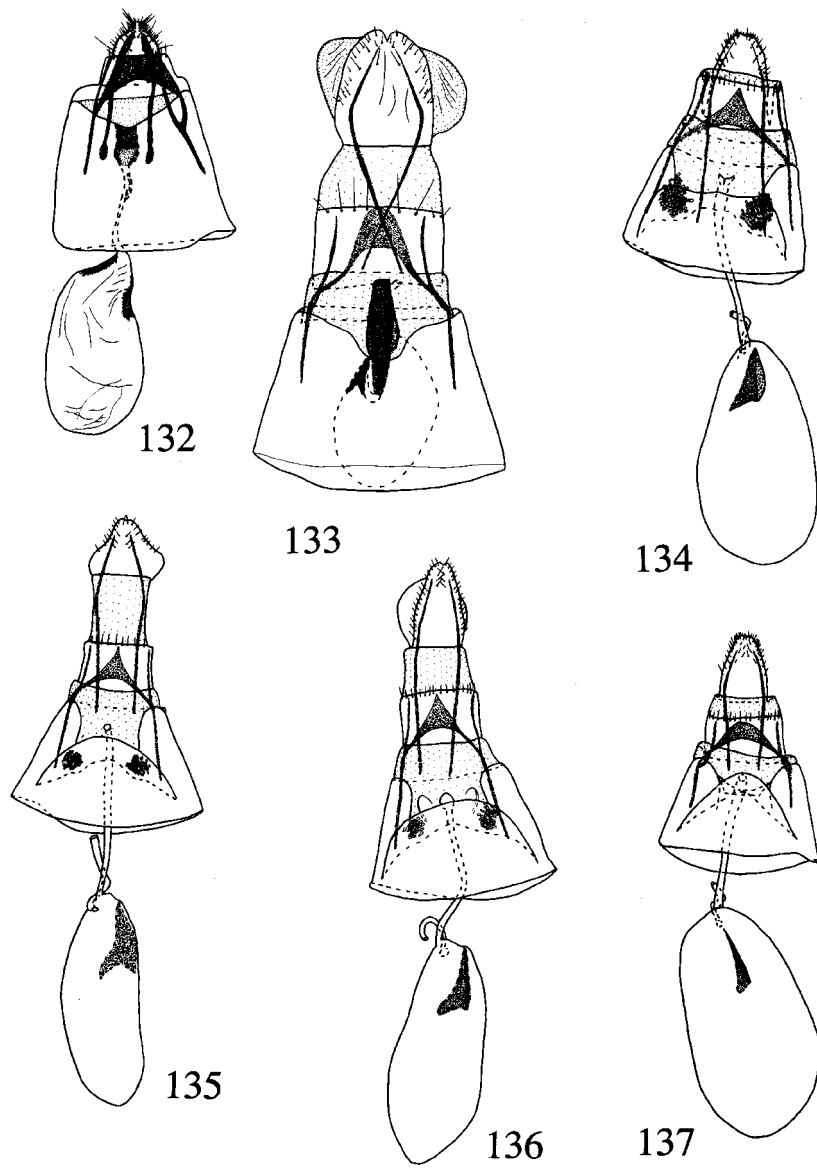

Figs. 132-137. Female genitalia of Heliodinidae, ventral aspect: 132, *Euheliodines chemsaki*; 133, *Aetole eximia*; 134, *A. bella*; 135, *A. schulzella*; 136, *A. fulgida*; 137, *A. prenticei*.

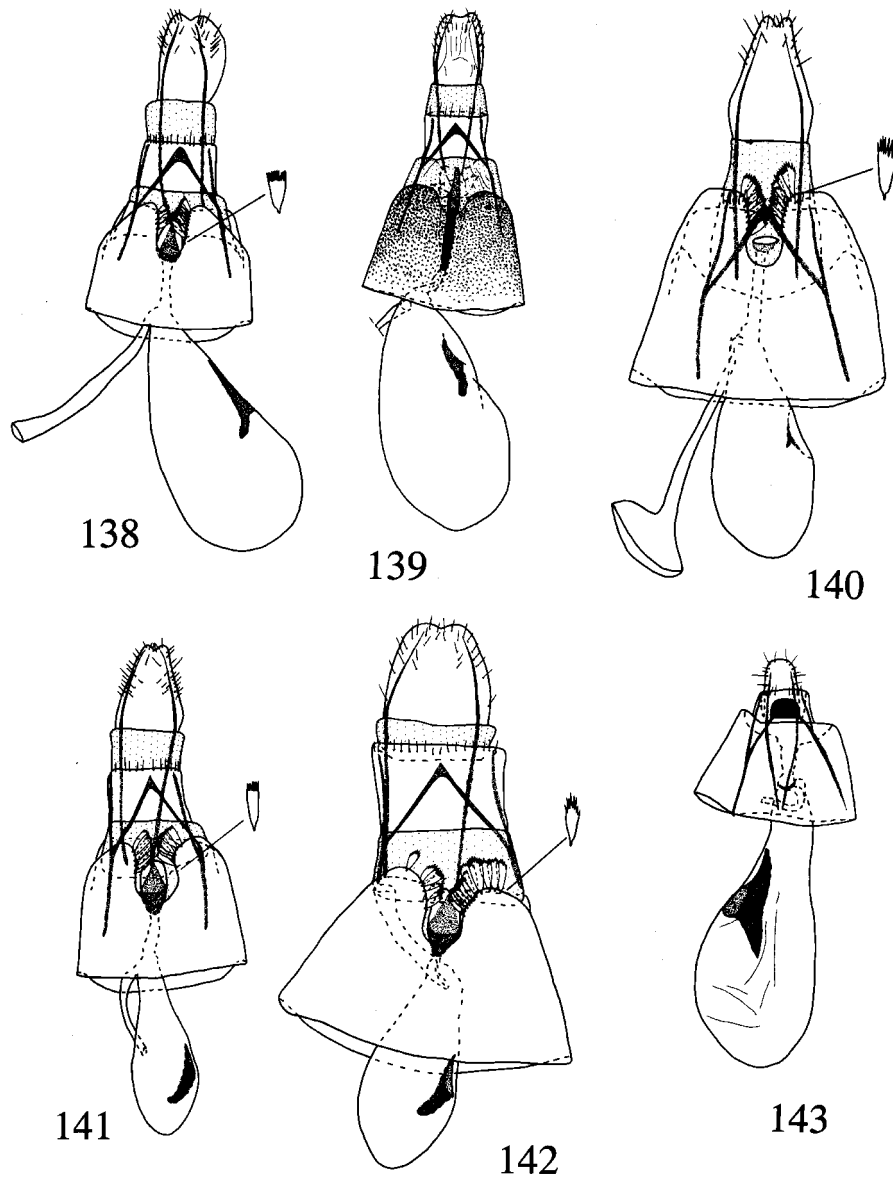

Figs. 138-143. Female genitalia of *Aetole*, ventral aspect: 138, *A. tripunctella*; 139, *A. unipunctella*; 140, *A. inusitata*; 141, *A. cera*; 142, *A. favonia*; 143, *A. extraneella*.

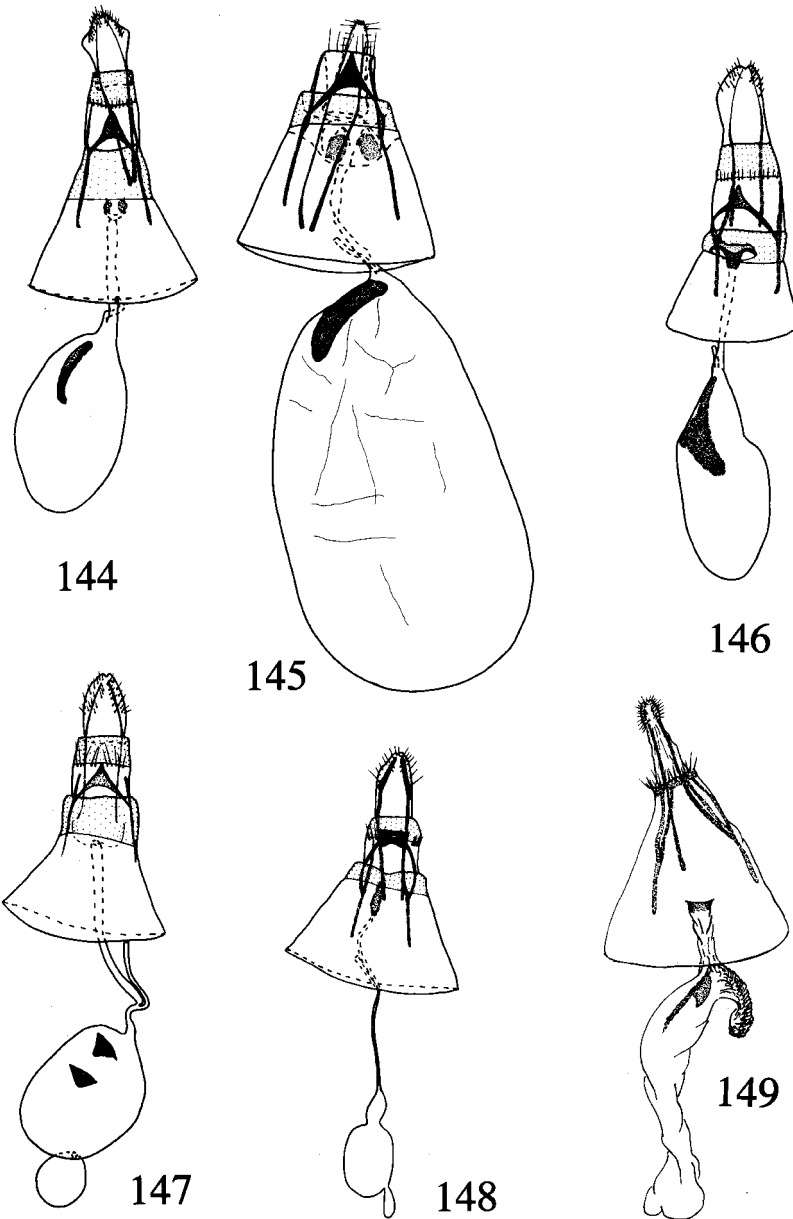

Figs. 144-149. Female genitalia of Heliodinidae, ventral aspect: 144, *Aetole calcifer*; 145, *A. calciferoides*; 146, *A. galapagoensis*; 147, *Scelorthus pisoniella*; 148, *Copocentra* species; 149, "*Heliodines*" *urichi*.

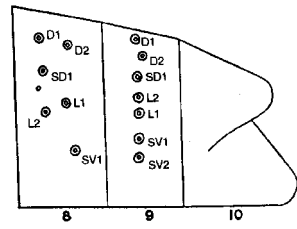
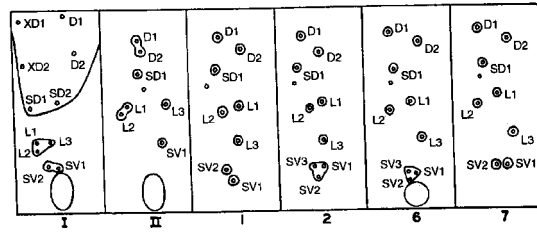

150

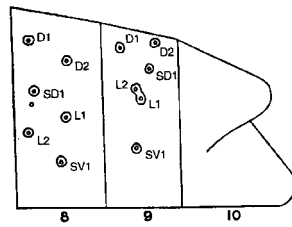
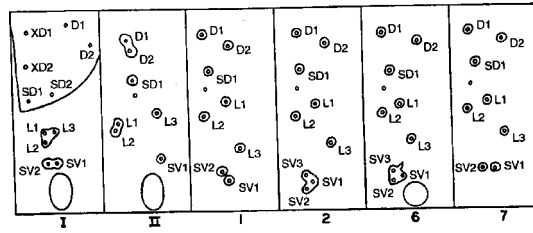

151

Figs. 150, 151. Larval chaetotaxy maps: 150, *Aetole extraneella*; 151, *Neoheliodines nyctaginella*.



Fig. 152 (upper). Adult *Aetole extraneella* on *Epilobium* in field, showing the upraised hind leg posture typical of *Aetole* and some other derived heliodinids; 153, adult *Neoheliodines vernius* on *Mirabilis* in field, showing posture without upraised hind legs, typical of *Neoheliodines* and other basal lineages.

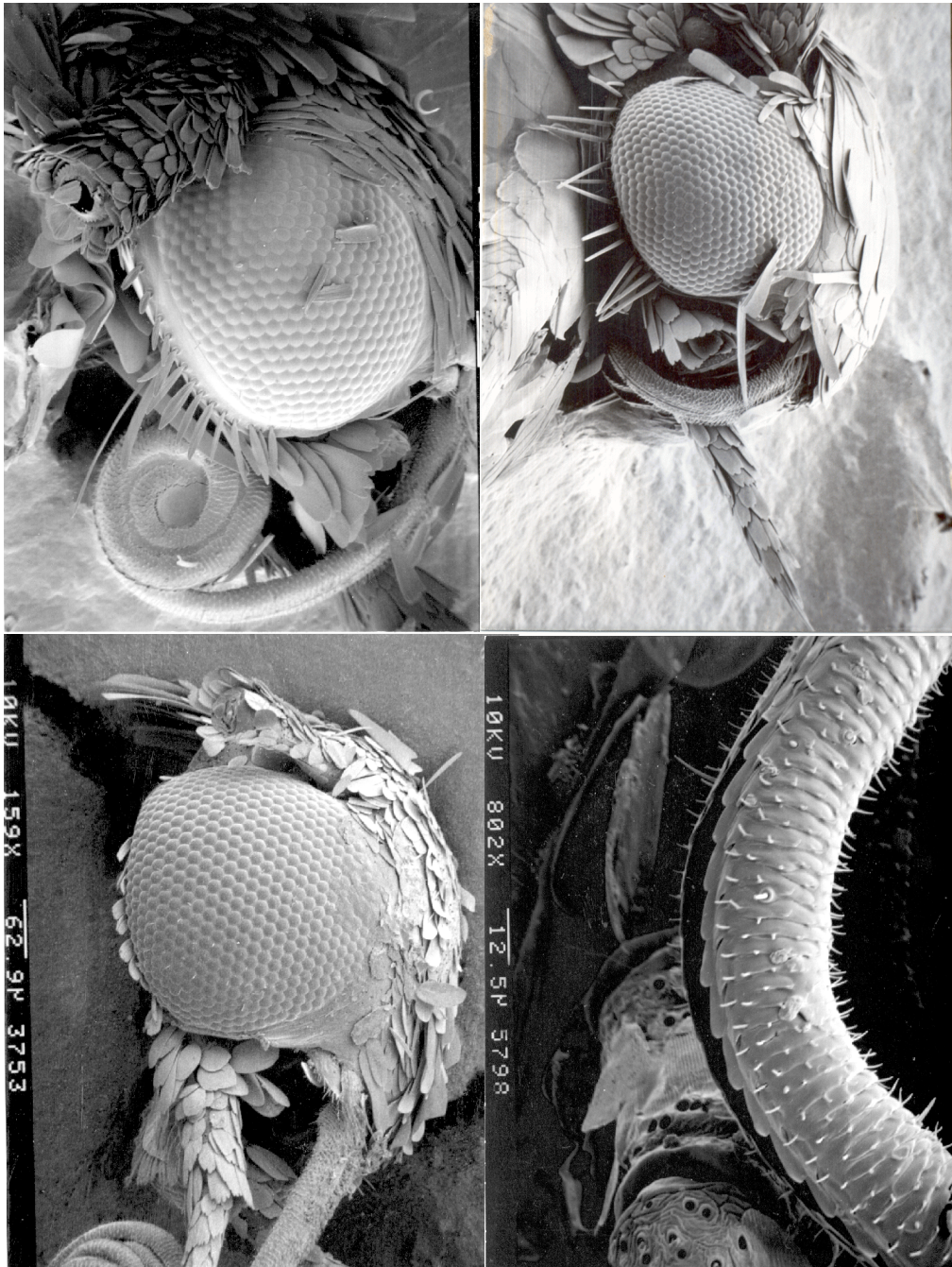

Figs. 154-157. SEM images of heliodinid head structures, lateral aspect: 154 (upper left), *Neoheliodines vernius*, eye and haustellum; 155 (upper right), *Scelorthus pisoniella*, eye, haustellum, labial palpus; 156 (lower left), *Aetole cera*, eye, haustellum, labial palpus; 157, *N. vernius*, basal section of haustellum.

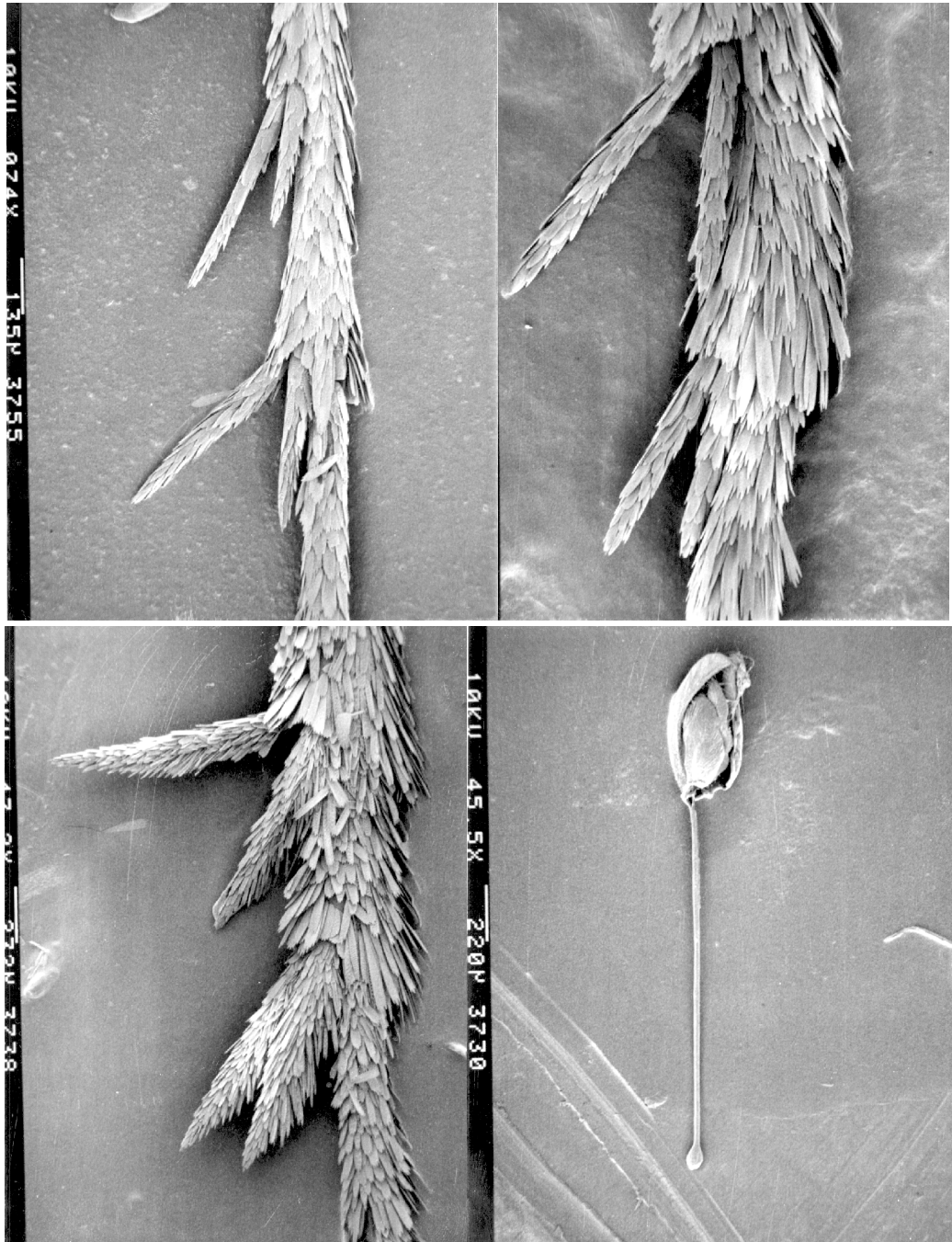

Figs. 158-160. SEM images of heliodinid metatibiae, lateral aspect: 158 (upper left), *Euheliodines chemsaki*; medial spurs above, distal spurs below; 159 (upper right), *Aetole prenticei*; 160 (lower left), *Scelorthus crucifer*; Fig. 161, male genitalia of *Embola ciccella*, lateral aspect, phallus removed.

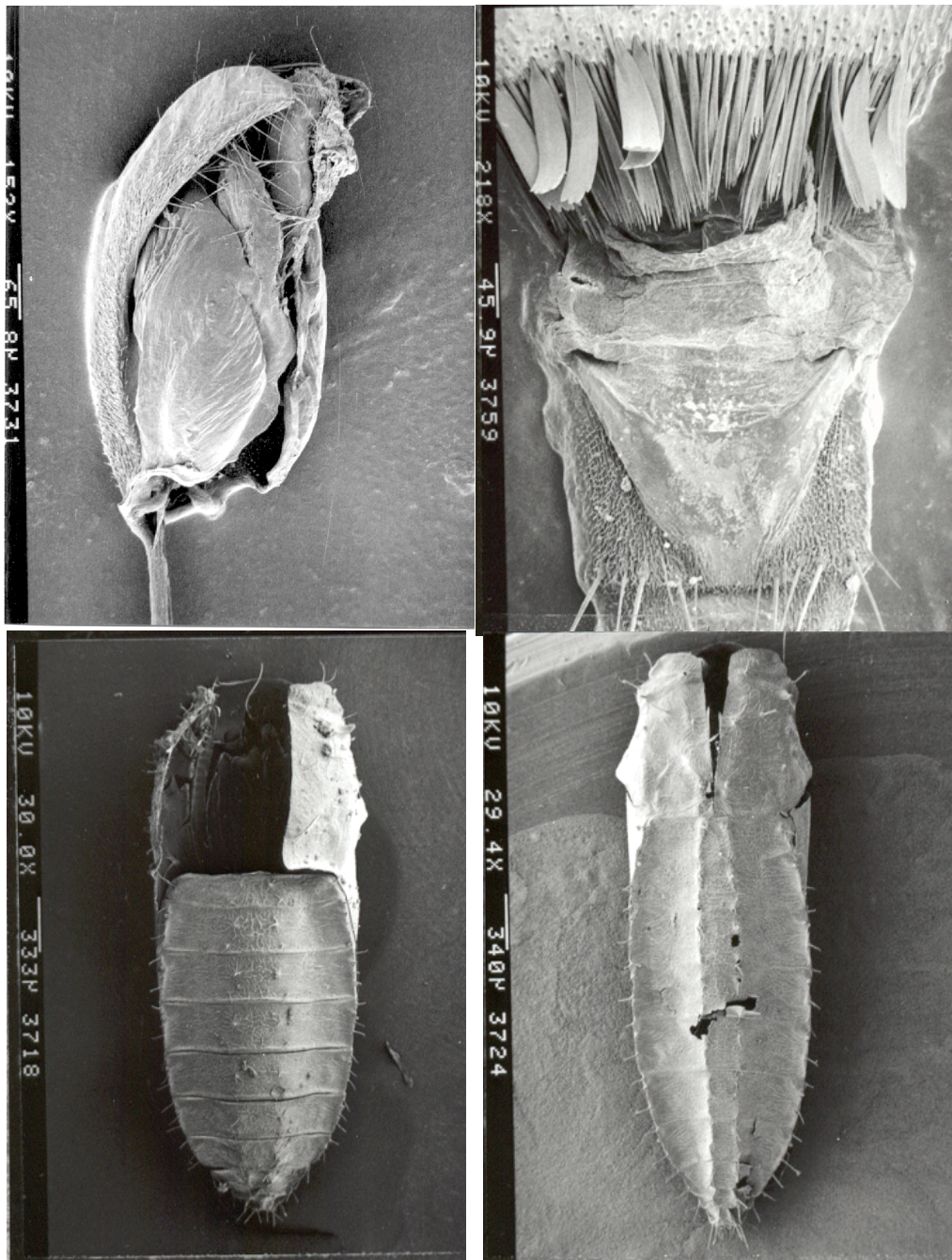

Figs. 162-165. SEM images of heliodinid structures: 162 (upper left), male genitalia of *Embola ciccella*, lateral aspect, aedeagus removed, saccus beyond base not shown; 163 (upper right), 8th abdominal segment, *Neoheliodines vernius*, ventral aspect; 164, 165, pupal shells, dorsal aspect: 164 (lower left), *Lamprolophus lithella*; 165, *Aetole fulgida*.

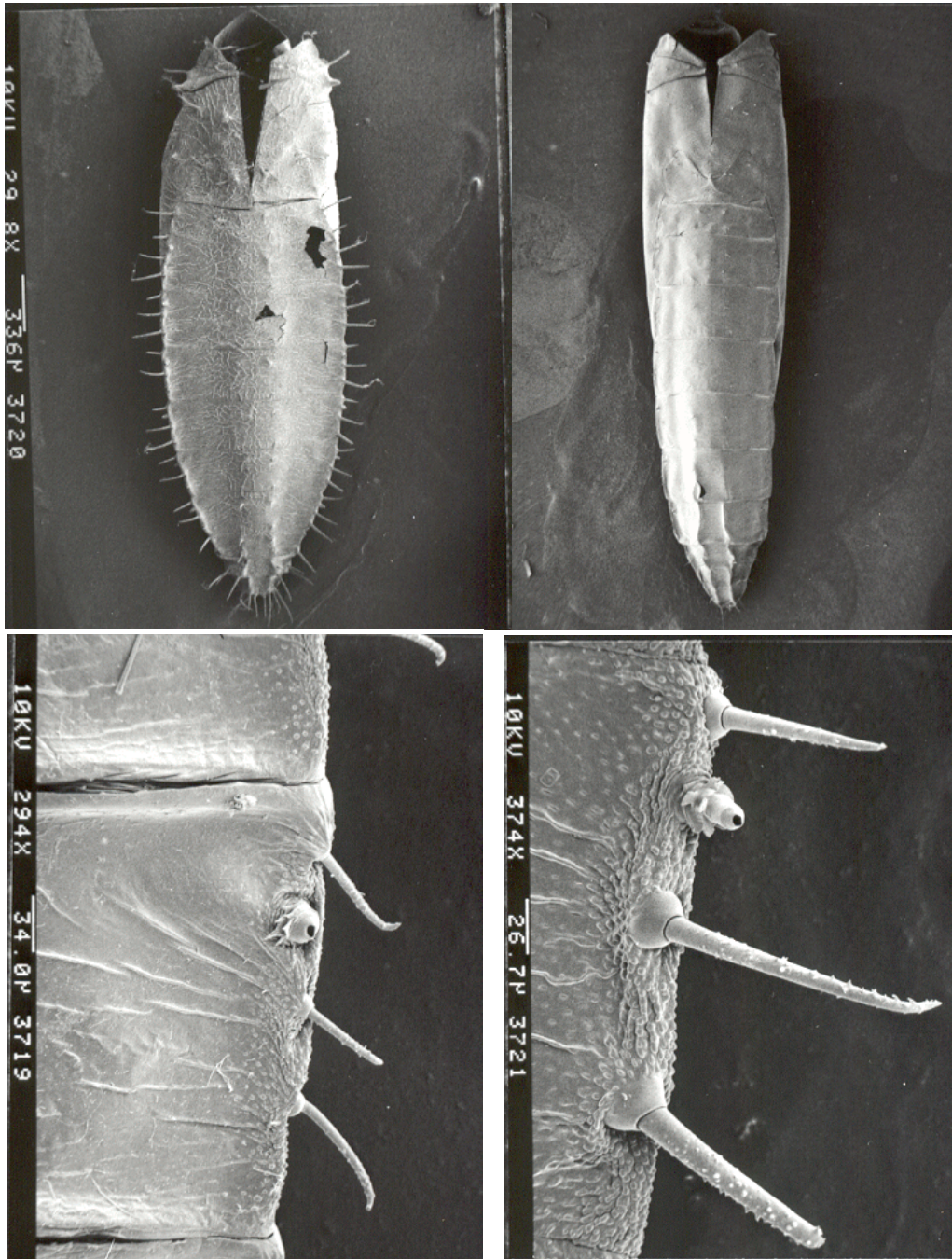

Figs. 166-169. Pupal structures of Heliodinidae: 166, 167, pupal shells, dorsal aspect: 166 (upper left), *Scelorthus pisoniella*; 167 (upper right), *Embola powelli*; 168, 169, lateral bristles of pupae: 168 (lower left), *Lamprolophus lithella*; 169, *Scelorthus pisoniella*.

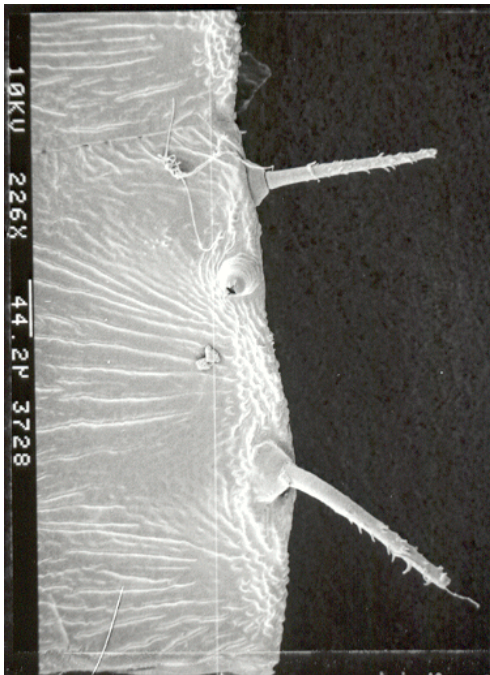
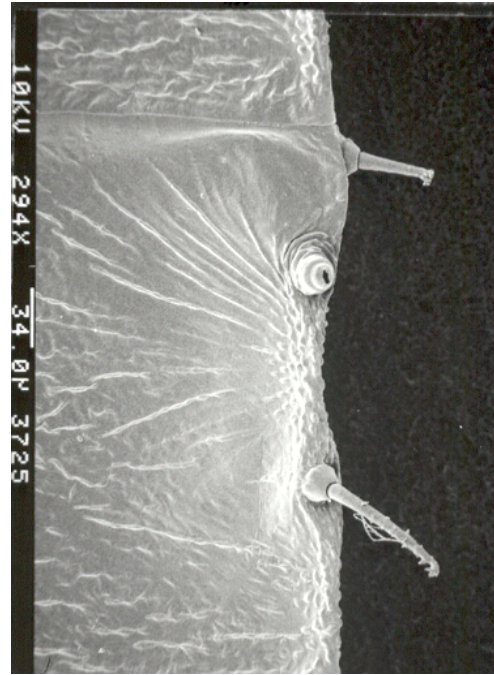
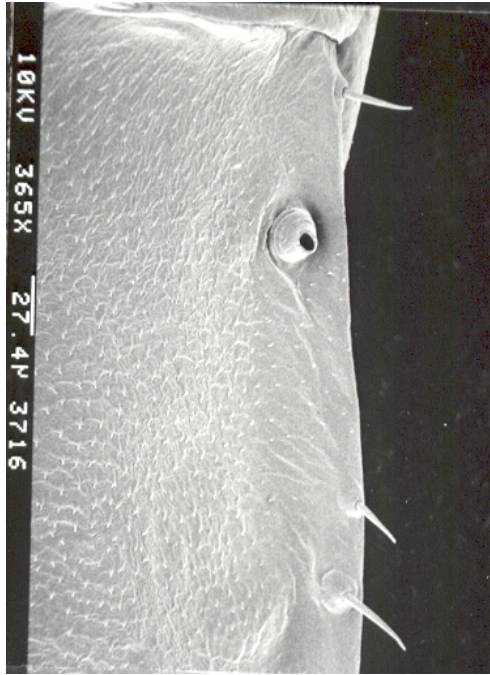

Figs. 170-172. Lateral pupal bristles of Heliodinidae: 170 (upper left), *Embola powelli*; 171(upper right), *Aetole fulgida*; 172, *A. unipunctella*.

Figs. 173-190. Adult specimens of Heliodinidae:

173, *Heliodines roesella*, Belgium, Antwerp (Hamfelt collection, USNM); 174, *Lamprolophus lithella*, FL, Royal Palm Hammock, Collier Co. (EME); 175, "*Heliodines*" *princeps*, Australia, Cedar Bay, Q. (BMNH); 176, *Lithariapteryx abroniaeella*, CA, Inglenook Fen, Mendocino Co. (EME); 177, *Neoheliodines nyctaginella*, IL, T14N, R9E, Coles Co. (EME); 178, *N. eurypterus*, AZ, Prescott, Yavapai Co. (EME).

179, *N. hodgesi*, holotype; 180, *N. megostiellus*, holotype; 181, *N. melanobasilarus*, holotype; 182, *N. vernius*, CA, Lakeside, S.D. Co. (EME); 183, *N. cliffordi*, IL, Charleston, Coles Co. (EME); 184, *N. arizonense*, holotype.

185, *Neoheliodines albidentus*, CO, Poncha Spr., Chaffee Co. (USNM); 186, *Embola ionis*, IL, T19N, R9E, Champaign Co.(EME); 187, *E. ciccella*, AZ, Cave Cr., Portal, Cochise Co. (EME); 188, *E. cyanozostera*, holotype; 189, *E. albaciliella*, AZ, Baboquivari Mts., Pima Co. (LACM); 190, *E. friedlanderi*, MEX, El Naranjo, S.L.P.(EME).



173



174



175



176



177



178



179



180



181



182



183



184



185



186



187



188



189



190

Figs. 191-205. Adult specimens of Heliodinidae:

191, *E. melanotela*, P.R., San Juan (USNM); 192, *E. autumnalis*, holotype; 193, *E. sexpunctella*, holotype; 194, *E. dentifer*, holotype; 195, *E. powelli*, holotype; 196, *Embola xanthocephala*, holotype.

197, *Pseudastasia opulenta*, holotype; 198, *Heliogemma gigantea*, MEX, Estac. Biol. Chamela, Jalisco (EME); 199, *H. grandis*, holotype; 200, *H. preclara*, holotype.

201, *Euheliodines chemsaki*, holotype; 202, *E. jaliscella*, holotype; 203, *Aetole eximia*, MEX, San Bartolo, Baja Calif. Sur (EME); 204, *A. insolita*, MEX, San Blas, Nayarit; 205, *A. bella*, MEX, San Bartolo, Baja Calif. Sur (EME).



Figs. 206-220. Adult specimens of Heliodinidae:

206, *A. schulzella*, TRINIDAD, Curepe (EME); 207, *A. fulgida*, holotype; 208, *A. prenticei*, CA, Lagoon Vy., Solano Co.(EME); 209, *A. tripunctella*, IL, Charleston, Coles Co. (EME); 210, *A. unipunctella*, AZ, 5 mi SW Kingman, Mohave Co. (EME); 211, *A. inusitata*, holotype.

212, *A. aprica*, holotype; 213, *A. cera*, CA, 18 mi. S Badwater, Death Vy. (EME); 214, *Aetole favonia*, holotype.

215, *A. extraneella*, CA, Edgewood Park, San Mateo Co. (EME); 216, *A. calcifer*, MEX, 18 mi S Guamachil, Sinaloa (EME); 217, *A. calciferoides*, holotype; 218, *A. galapagoensis*, ECUADOR, Espanola, Bahia Manzanillo, Galapagos Is.(EME); 219, *Copocentra calliscelis*, PERU, Cuzco Mts. (BMNH); 220, *Scelorthus pisoniella*, FL, Vaca Key, Monroe Co. (EME).

